



9 Dishwasher racks

Cestas para vajilla
Casiers à vaisselle

9.1 OPEN RACKS 230

CESTAS ABIERTAS
CASIERIS OUVERTS

9.2 OPEN ASSEMBLED RACKS 232

CESTAS MONTADAS ABIERTAS
CASIERIS MONTÉS OUVERTS

9.3 CLOSED ASSEMBLED RACKS 234

CESTAS MONTADAS CERRADAS
CASIERIS MONTÉS FERMÉS

9.4 COMPLEMENTS 236

COMPLEMENTOS
COMPLÉMENTS

9.5 PLATE RACKS 238

CESTAS PARA PLATOS
CASIERIS ASSIETTES

Easy assembly and disassembly system.
Sistema de montaje y desmontaje fácil.
Système de montage et démontage facile.

OPEN - WASHING
ABIERTA - LAVADO
OUVERT - LAVAGE

Faster wash and rinse.
Limpeza y secado rápido.
Lavage et séchage plus rapide.

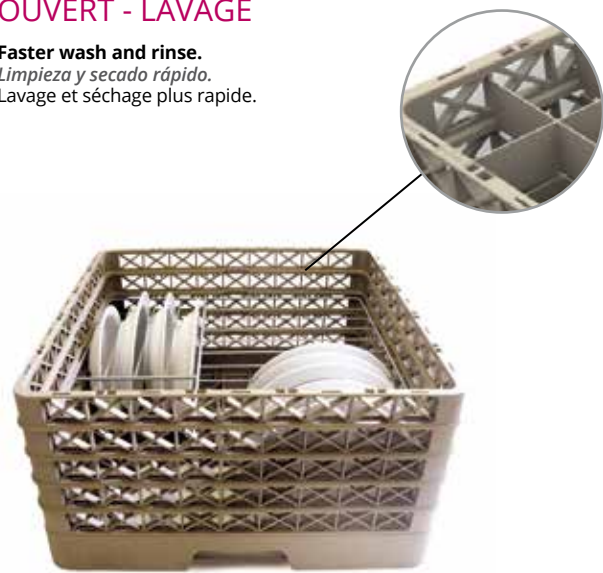

Stackable with other brands of racks, reinforced double-wall (anti-shock).

Apilables con otras cestas del mercado, refuerzo de doble pared (anti-golpes).

Empilables avec d'autres casiers du marché, renfort avec double paroi (anti-choc).

CLOSED - TRANSPORT
CERRADA - TRANSPORTE
FERMÉ - TRANSPORT

More safety and hygienic storing and transporting.
Almacenamiento y transporte más seguro e higiénico.
Stockage et transport plus sûr et hygiénique.



GET THE BEST OF BOTH WORLDS*
*ESCOGER LO BUENO Y LO MEJOR A LA VEZ**
*LE BON ET LE MEILLEUR À LA FOIS**

FLAP-RACK®: easy to assemble / disassemble
FLAP-RACK®: fácil montaje / desmontaje
FLAP-RACK®: facile à monter / démonter

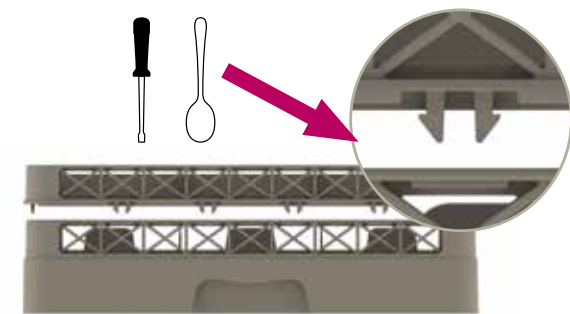

* Copolymer highly resistant to chemical products and temperatures up to 95 °C.
* Copolímero altamente resistente a sustancias químicas y temperaturas de hasta 95 °C.
* Copolymère très résistant aux produits chimiques et à températures jusqu'à 95 °C.

SQUARE COMPARTMENTS
COMPARTIMENTOS CUADRADOS
COMPARTIMENTS CARRÉS

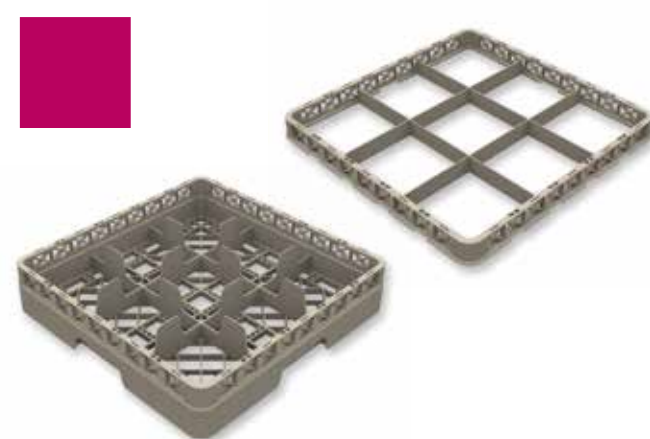

System patented allows the walls on both bases and extenders to be closed or open easily

Sistema patentado que permite cerrar y abrir las paredes de las cestas y extensiones fácilmente

Système breveté qui permet d'ouvrir ou de fermer facilement les parois des casiers et des réhausse

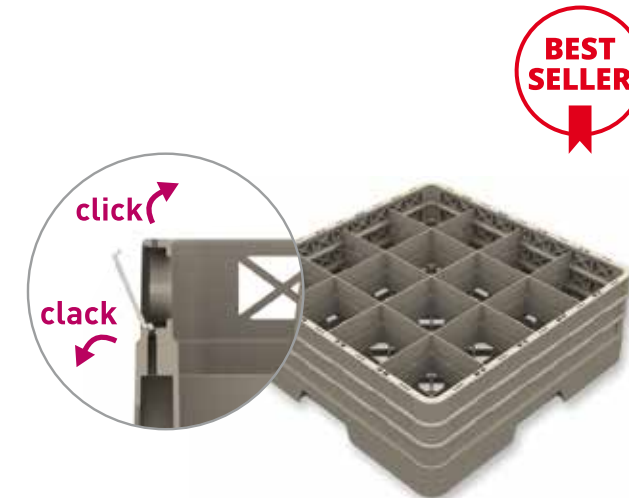

WASHING: Higher cleaning
LAVADO: Mayor limpieza
LAVAGE: Meilleur nettoyage



TRANSPORT: Higher security
TRANSPORTE: Mayor seguridad
TRANSPORT: Plus de sécurité



STORING: Higher hygiene
ALMACENAMIENTO: Mayor Higiene
STOCKAGE: Plus hygiénique

FLAP IDENTIFICADOR

Colour identification for completely closed racks and extensions.
Available in 6 colours. Possible customization.

Identificador de colores para cestas y extensiones completamente cerradas. Disponible en 6 colores. Posibilidad de marcar logo cliente.

Identificateur en couleurs pour casiers et réhausse complètement fermés. Disponible en 6 couleurs. Personnalisation possible.

501F Flap

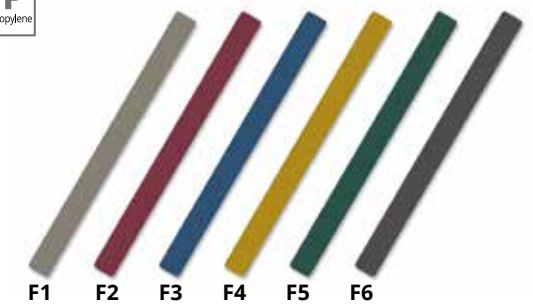

| REF | Colour / Color / Couleur | € / u | 📦 |
|---------|---|-------|----|
| P501 F1 | Brown / Marrón / Marron | 1,45 | 24 |
| P501 F2 | Burgundy / Burdeos / Bordeaux | 1,45 | 24 |
| P501 F3 | Blue / Azul / Bleu | 1,45 | 24 |
| P501 F4 | Yellow / Amarillo / Jaune | 1,45 | 24 |
| P501 F5 | Green / Verde / Vert | 1,45 | 24 |
| P501 F6 | Dark brown / Marrón oscuro / Marron foncé | 1,45 | 24 |



Printed logo or text / Logo o texto impreso / Logo ou texte imprimé



Hot stamped logo or text / Logo o texto estampado / Logo ou texte gravé

T-VERSION

DESIGNED TO HOLD 17-30% MORE GLASSWARE THAN A TRADITIONAL RACK

DISEÑADAS CON UN 17-30% MÁS DE CAPACIDAD PARA VASOS Y COPAS QUE LAS CESTAS TRADICIONALES

CONÇUS POUR CONTENIR DE 17 À 30 % DE VERRES EN PLUS QU'UN CASIER TRADITIONNEL

SNAP-FIT EXTENDERS

Will not loosen or come apart over time
Assembled racks can not be refunded

EXTENSORES A PRESIÓN

No se sueltan con el tiempo
No se aceptan devoluciones de cestas montadas

RÉHAUSSES CLIPSABLES

Sans détachements au fil du temps
Tout retour de casiers montés n'est pas accepté

HEXAGONAL COMPARTMENTS
COMPARTIMENTOS HEXAGONALES
COMPARTIMENTS HEXAGONAUX



SMALL SIDE COMPARTMENTS

hold flatware, salt shakers, ramekins, ...

LOS COMPARTIMENTOS LATERALES PEQUEÑOS aceptan cubiertos, saleros, potes, ...

PETITS COMPARTIMENTS LATÉRAUX pour couverts, salières, ramequins, ...

OPEN PROFILE DESIGN

Allows top-to-bottom and side-to-side washing and drying

DISEÑO DE PERFIL ABIERTO

Permite un lavado y secado de arriba a abajo y de lado a lado

CONCEPT À PROFIL OUVERT

Permet un lavage et un séchage de haut en bas et d'un côté à l'autre

CONVENIENT HANDLING With handles in all four sides

MANEJO CÓMODO Con asas en los cuatro lados
MANIPULATION PRATIQUE Grâce aux poignées des quatre côtés

BUILT-IN BASE RACK DIVIDERS provide 100% vertical glassware protection

LOS DIVISORES INCORPORADOS brindan una protección 100% vertical de los vasos y las copas
LES PARTITIONS DE CASIER DE BASE INTÉGRÉES offrent une protection des verres 100% verticale

COLOUR IDENTIFICATION CLIP for easy identification

CLIPS DE IDENTIFICACIÓN DE COLORES para facilitar la identificación
CLIPS IDENTIFICATEURS EN COULEURS pour une identification plus facile



T-VERSION

CLIP Clip tags / Clip identificación / Clip d'identification

| REF | Colour / Color | € / u | 📦 |
|---------|----------------|-------|----|
| 1009-01 | | 2,80 | 12 |
| 1009-02 | | 2,80 | 12 |
| 1009-03 | | 2,80 | 12 |
| 1009-04 | | 2,80 | 12 |
| 1009-05 | | 2,80 | 12 |
| 1009-06 | | 2,80 | 12 |
| 1009-08 | | 2,80 | 12 |
| 1009-19 | | 2,80 | 12 |
| 1009-32 | | 2,80 | 12 |

| | | | |
|----|-----------------------------------|----|-----------------------------------|
| 01 | Brown / Marrón Marron | 06 | Black / Negro Noir |
| 02 | Red / Rojo Rouge | 08 | Yellow / Amarillo Jaune |
| 03 | Orange / Naranja Orange | 19 | Green / Verde Vert |
| 04 | Blue / Azul Bleu | 32 | Beige / Beige Beige |
| 05 | White / Blanco Blanc | | |

Dishwasher racks selection

Selección cestas para vajilla
Sélection casiers à vaisselle

FLAP RACK®

T-VERSION

FLAPS



CLIP TAGS

CLIP IDENTIFICACIÓN
CLIP D'IDENTIFICATION



OPENED RACKS

CESTAS ABIERTAS
CASIERS OUVERTS



CLOSED RACKS

CESTAS CERRADAS
CASIERS FERMÉES



HALF-SIZE RACKS

CESTAS MEDIO TAMAÑO
CASIERS DEMI-TAILLE



DISASSEMBLY

DESMONTABLE
DÉMONTABLE



COMPARTMENTS

COMPARTIMENTOS
COMPARTIMENTS



COMPARTMENTS

COMPARTIMENTOS
COMPARTIMENTS



9.1 Open racks

Cestas abiertas
Casiers ouverts



∅ max. 151 mm

FLAP RACK

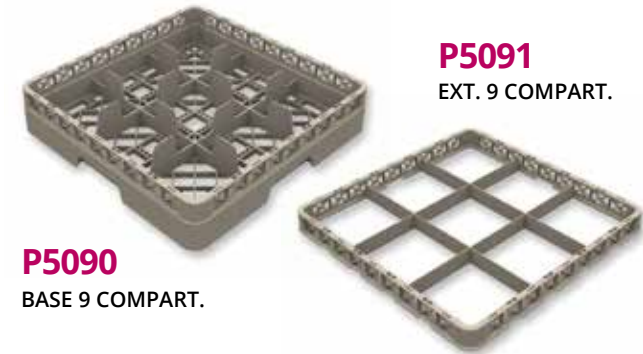

P5090
BASE 9 COMPART.

P5091
EXT. 9 COMPART.

| REF | €/u | 📦 |
|-------|-------|----|
| P5090 | 26,45 | 6 |
| P5091 | 12,45 | 12 |

∅ max. 122 mm

T-VERSION

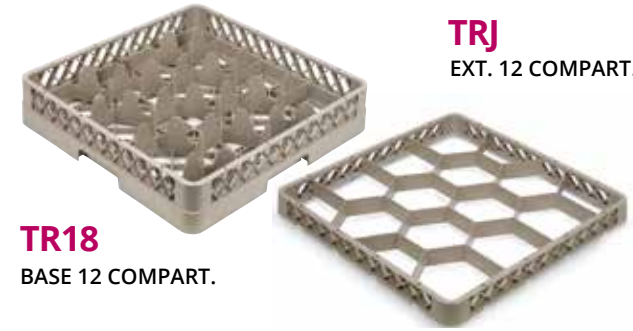

TR18
BASE 12 COMPART.

TRJ
EXT. 12 COMPART.

| REF | €/u | 📦 |
|------|-------|----|
| TR18 | 32,65 | 6 |
| TRJ | 13,90 | 12 |

∅ max. 113 mm

FLAP RACK

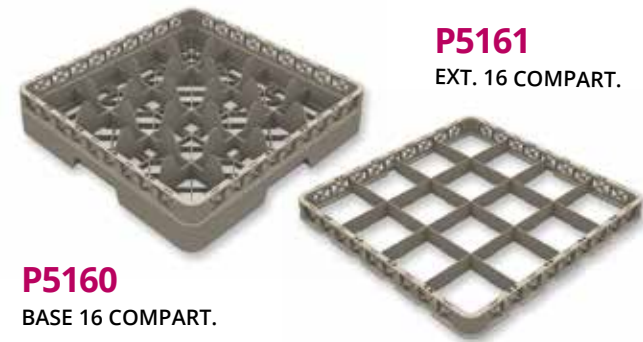

P5160
BASE 16 COMPART.

P5161
EXT. 16 COMPART.

| REF | €/u | 📦 |
|-------|-------|----|
| P5160 | 29,45 | 6 |
| P5161 | 12,60 | 12 |

∅ max. 100 mm

T-VERSION

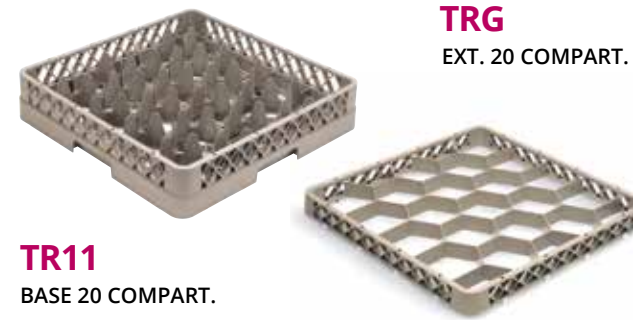

TR11
BASE 20 COMPART.

TRG
EXT. 20 COMPART.

| REF | €/u | 📦 |
|------|-------|----|
| TR11 | 33,55 | 6 |
| TRG | 14,45 | 12 |

∅ max. 89 mm

FLAP RACK



P5250
BASE 25 COMPART.

P5251
EXT. 25 COMPART.

| REF | €/u | 📦 |
|-------|-------|----|
| P5250 | 30,70 | 6 |
| P5251 | 13,35 | 12 |

Open racks 9.1

Cestas abiertas
Casiers ouverts



∅ max. 81 mm

T-VERSION



TR12
BASE 30 COMPART.

TRH
EXT. 30 COMPART.

| REF | €/u | 📦 |
|------|-------|----|
| TR12 | 35,45 | 6 |
| TRH | 15,20 | 12 |

∅ max. 73 mm

FLAP RACK



P5360
BASE 36 COMPART.

P5361
EXT. 36 COMPART.

| REF | €/u | 📦 |
|-------|-------|----|
| P5360 | 32,55 | 6 |
| P5361 | 13,80 | 12 |

∅ max. 70 mm

T-VERSION

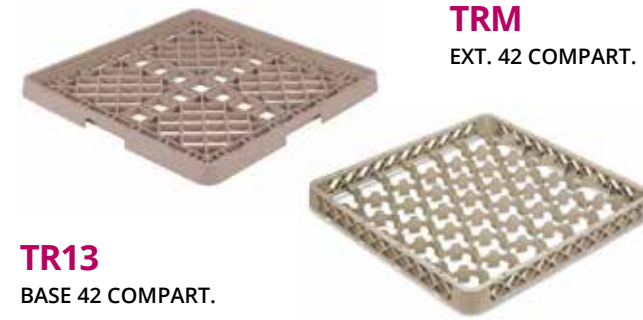

TR13
BASE 42 COMPART.

TRM
EXT. 42 COMPART.

| REF | €/u | 📦 |
|------|-------|----|
| TR13 | 38,55 | 6 |
| TRM | 15,55 | 12 |

∅ max. 63 mm

FLAP RACK



P5490
BASE 49 COMPART.

P5491
EXT. 49 COMPART.

| REF | €/u | 📦 |
|-------|-------|----|
| P5490 | 33,70 | 6 |
| P5491 | 14,25 | 12 |

9.2 Open assembled racks

Cestas montadas abiertas
Casiers montés ouverts



∅ max. 151 mm **9 COMPART.**

FLAP RACK

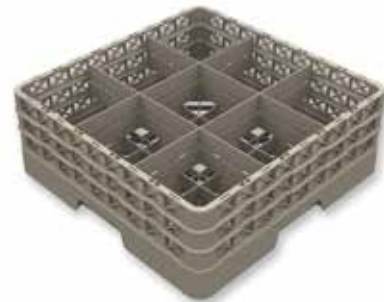

| REF | ∆lmax. (mm) | H (mm)* | €/u | ∅ |
|----------|-------------|---------|-------|---|
| P5090 E1 | 120 | 140 | 39,40 | 1 |
| P5090 E2 | 160 | 180 | 51,95 | 1 |
| P5090 E3 | 200 | 220 | 64,55 | 1 |
| P5090 E4 | 240 | 260 | 77,15 | 1 |
| P5090 E5 | 280 | 300 | 89,70 | 1 |

∅ max. 122 mm **12 COMPART.**

T-VERSION



| REF | ∆lmax. (mm) | H (mm)* | €/u | ∅ |
|------------|-------------|---------|--------|---|
| TR18 J | 122 | 140 | 47,45 | 2 |
| TR18 JJ | 162 | 181 | 62,05 | 2 |
| TR18 JJJ | 200 | 222 | 76,35 | 2 |
| TR18 JJJJ | 240 | 262 | 88,95 | 2 |
| TR18 JJJJJ | 279 | 302 | 104,25 | 2 |

∅ max. 113 mm **16 COMPART.**

FLAP RACK



| REF | ∆lmax. (mm) | H (mm)* | €/u | ∅ |
|----------|-------------|---------|-------|---|
| P5160 E1 | 120 | 140 | 43,90 | 1 |
| P5160 E2 | 160 | 180 | 57,15 | 1 |
| P5160 E3 | 200 | 220 | 70,30 | 1 |
| P5160 E4 | 240 | 260 | 83,40 | 1 |
| P5160 E5 | 280 | 300 | 96,55 | 1 |

∅ max. 100 mm **20 COMPART.**

T-VERSION



| REF | ∆lmax. (mm) | H (mm)* | €/u | ∅ |
|-------------|-------------|---------|--------|---|
| TR11 G | 122 | 140 | 49,65 | 2 |
| TR11 GGG | 162 | 181 | 65,00 | 2 |
| TR11 GGGG | 200 | 222 | 79,95 | 2 |
| TR11 GGGGG | 240 | 262 | 94,70 | 2 |
| TR11 GGGGGG | 279 | 302 | 111,35 | 2 |

∅ max. 89 mm **25 COMPART.**

FLAP RACK



| REF | ∆lmax. (mm) | H (mm)* | €/u | ∅ |
|----------|-------------|---------|-------|---|
| P5250 E1 | 120 | 140 | 44,65 | 1 |
| P5250 E2 | 160 | 180 | 57,95 | 1 |
| P5250 E3 | 200 | 220 | 71,35 | 1 |
| P5250 E4 | 240 | 260 | 84,85 | 1 |
| P5250 E5 | 280 | 300 | 98,35 | 1 |

Open assembled racks 9.2

Cestas montadas abiertas
Casiers montés ouverts



∅ max. 81 mm **30 COMPART.**

T-VERSION



| REF | ∆lmax. (mm) | H (mm)* | €/u | ∅ |
|------------|-------------|---------|--------|---|
| TR12 H | 122 | 140 | 52,15 | 2 |
| TR12 HH | 162 | 181 | 66,95 | 2 |
| TR12 HHH | 200 | 222 | 82,20 | 2 |
| TR12 HHHH | 240 | 262 | 97,50 | 2 |
| TR12 HHHHH | 279 | 302 | 113,55 | 2 |

∅ max. 70 mm **42 COMPART.**

T-VERSION



| REF | ∆lmax. (mm) | H (mm)* | €/u | ∅ |
|-----------|-------------|---------|--------|---|
| TR13 M | 52 | 73 | 53,45 | 2 |
| TR13 MM | 91 | 114 | 68,75 | 2 |
| TR13 MMM | 130 | 156 | 84,55 | 2 |
| TR13 MMMM | 172 | 194 | 100,25 | 2 |

* Total set height
* Altura total del conjunto
* Hauteur totale ensemble

∅ max. 73 mm **36 COMPART.**

FLAP RACK



| REF | ∆lmax. (mm) | H (mm)* | €/u | ∅ |
|----------|-------------|---------|-------|---|
| P5360 E1 | 120 | 140 | 45,50 | 1 |
| P5360 E2 | 160 | 180 | 58,60 | 1 |
| P5360 E3 | 200 | 220 | 71,80 | 1 |
| P5360 E4 | 240 | 260 | 84,95 | 1 |
| P5360 E5 | 280 | 300 | 99,25 | 1 |

∅ max. 63 mm **49 COMPART.**

FLAP RACK



| REF | ∆lmax. (mm) | H (mm)* | €/u | ∅ |
|----------|-------------|---------|--------|---|
| P5490 E1 | 120 | 140 | 47,25 | 1 |
| P5490 E2 | 160 | 180 | 61,35 | 1 |
| P5490 E3 | 200 | 220 | 75,30 | 1 |
| P5490 E4 | 240 | 260 | 89,40 | 1 |
| P5490 E5 | 280 | 300 | 105,40 | 1 |

See products on
Ver productos en / Voir produits en page

P. 260

Trolley for dishwasher racks
Carro para cestas
Chariot pour casiers à vaisselle



9.3 Closed assembled racks

Cestas montadas cerradas
Casiers montés fermés



∅ max. 151 mm

FLAP RACK

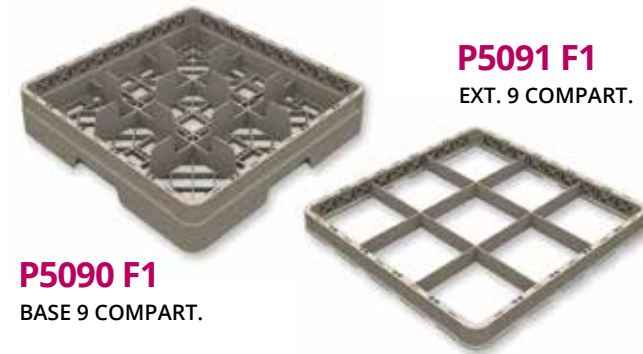

P5091 F1
EXT. 9 COMPART.

P5090 F1
BASE 9 COMPART.

| REF | €/u | 📦 |
|----------|-------|----|
| P5090 F1 | 27,30 | 6 |
| P5091 F1 | 13,90 | 12 |

∅ max. 113 mm

FLAP RACK

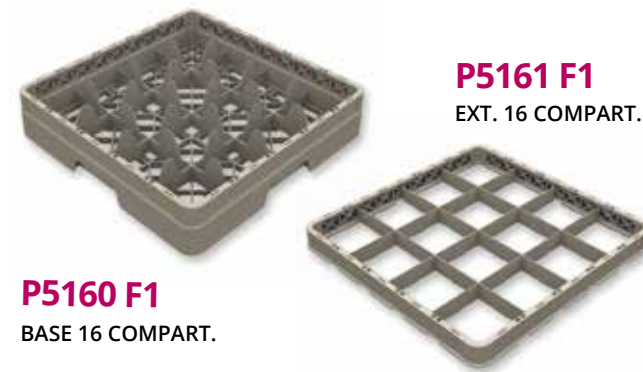

P5161 F1
EXT. 16 COMPART.

P5160 F1
BASE 16 COMPART.

| REF | €/u | 📦 |
|----------|-------|----|
| P5160 F1 | 30,25 | 6 |
| P5161 F1 | 14,00 | 12 |

∅ max. 89 mm

FLAP RACK

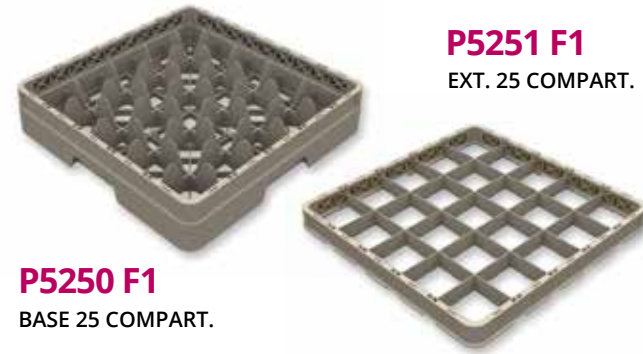

P5251 F1
EXT. 25 COMPART.

P5250 F1
BASE 25 COMPART.

| REF | €/u | 📦 |
|----------|-------|----|
| P5250 F1 | 31,25 | 6 |
| P5251 F1 | 14,65 | 12 |

∅ max. 73 mm

FLAP RACK

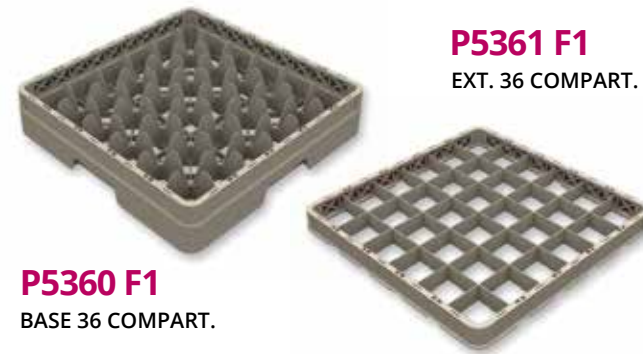

P5361 F1
EXT. 36 COMPART.

P5360 F1
BASE 36 COMPART.

| REF | €/u | 📦 |
|----------|-------|----|
| P5360 F1 | 32,35 | 6 |
| P5361 F1 | 14,25 | 12 |

∅ max. 63 mm

FLAP RACK

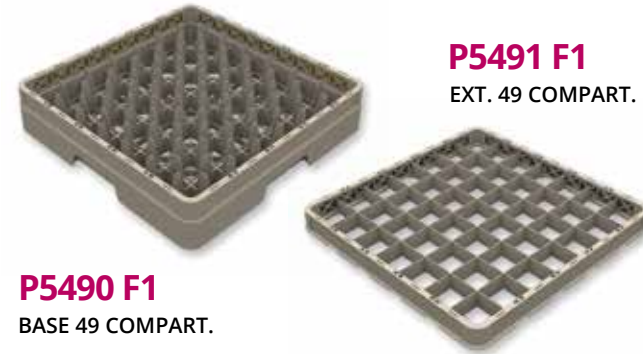

P5491 F1
EXT. 49 COMPART.

P5490 F1
BASE 49 COMPART.

| REF | €/u | 📦 |
|----------|-------|----|
| P5490 F1 | 33,55 | 6 |
| P5491 F1 | 15,00 | 12 |

FLAP RACK

Indicate the colour code at the end of the reference.
Indicar el código de color al final de la referencia.
Indiquer le code de couleur a la fin de la référence.



F1 F2 F3



F4 F5 F6

Closed assembled racks 9.3

Cestas montadas cerradas
Casiers montés fermés



∅ max. 151 mm 9 COMPART.

FLAP RACK



| REF | ∆max. (mm) | H (mm)* | €/u | 📦 |
|------------|------------|---------|-------|---|
| P5090 E1F1 | 120 | 140 | 44,35 | 1 |
| P5090 E2F1 | 160 | 180 | 57,50 | 1 |
| P5090 E3F1 | 200 | 220 | 70,10 | 1 |
| P5090 E4F1 | 240 | 260 | 84,60 | 1 |
| P5090 E5F1 | 280 | 300 | 99,05 | 1 |

∅ max. 89 mm 25 COMPART.

FLAP RACK



| REF | ∆max. (mm) | H (mm)* | €/u | 📦 |
|------------|------------|---------|-------|---|
| P5250 E1F1 | 120 | 140 | 44,05 | 1 |
| P5250 E2F1 | 160 | 180 | 60,35 | 1 |
| P5250 E3F1 | 200 | 220 | 73,30 | 1 |
| P5250 E4F1 | 240 | 260 | 87,60 | 1 |
| P5250 E5F1 | 280 | 300 | 99,75 | 1 |

∅ max. 63 mm 49 COMPART.

FLAP RACK



| REF | ∆max. (mm) | H (mm)* | €/u | 📦 |
|------------|------------|---------|--------|---|
| P5490 E1F1 | 120 | 140 | 43,90 | 1 |
| P5490 E2F1 | 160 | 180 | 56,70 | 1 |
| P5490 E3F1 | 200 | 220 | 69,70 | 1 |
| P5490 E4F1 | 240 | 260 | 84,60 | 1 |
| P5490 E5F1 | 280 | 300 | 101,35 | 1 |

∅ max. 113 mm 16 COMPART.

FLAP RACK



| REF | ∆max. (mm) | H (mm)* | €/u | 📦 |
|------------|------------|---------|-------|---|
| P5160 E1F1 | 120 | 140 | 44,15 | 1 |
| P5160 E2F1 | 160 | 180 | 58,60 | 1 |
| P5160 E3F1 | 200 | 220 | 73,25 | 1 |
| P5160 E4F1 | 240 | 260 | 87,70 | 1 |
| P5160 E5F1 | 280 | 300 | 99,10 | 1 |

∅ max. 73 mm 36 COMPART.

FLAP RACK



| REF | ∆max. (mm) | H (mm)* | €/u | 📦 |
|------------|------------|---------|--------|---|
| P5360 E1F1 | 120 | 140 | 43,65 | 1 |
| P5360 E2F1 | 160 | 180 | 58,85 | 1 |
| P5360 E3F1 | 200 | 220 | 72,25 | 1 |
| P5360 E4F1 | 240 | 260 | 83,95 | 1 |
| P5360 E5F1 | 280 | 300 | 100,00 | 1 |

FLAP RACK

* Total set height
* Altura total del conjunto
* Hauteur totale ensemble

Indicate the colour code at the end of the reference.
Indicar el código de color al final de la referencia.
Indiquer le code de couleur a la fin de la référence.



F1 F2 F3



F4 F5 F6

9.4 Complements

Complementos
Compléments



P5002 Open rack
Cesta universal
Panier universel

FLAP RACK®

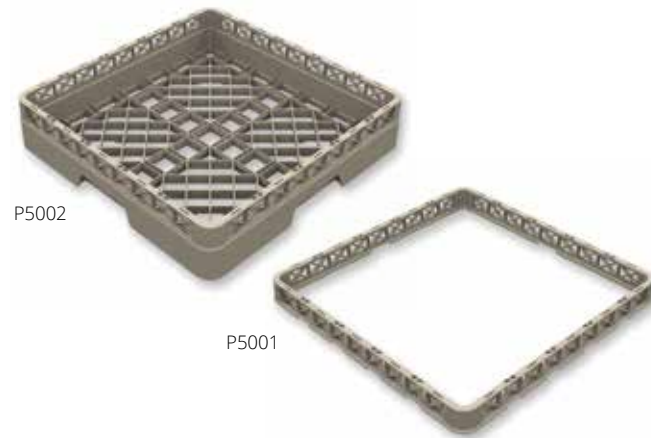

P5001 Compatible only with FlapRack® dishwasher racks.
Compatible sólo con las cestas FlapRack®.
Compatible uniquement avec les casiers de lavage FlapRack®.

TRA* Compatible only with T-Version dishwasher racks.
Compatible sólo con las cestas T-Version.
Compatible uniquement avec les casiers de lavage T-Version.

| REF | €/u | |
|-------|-------|----|
| P5002 | 27,95 | 6 |
| P5001 | 9,70 | 12 |
| TRA* | 14,20 | 12 |

TR33 Racks lid
Tapa para cestas
Couvercle pour paniers

FLAP RACK®



| REF | €/u | |
|------|-------|---|
| TR33 | 35,10 | 6 |

P5000 Plate, tray and cutlery racks
Cesta para platos, bandejas y cubiertos
Paniers pour plats, plateaux et couverts

FLAP RACK®

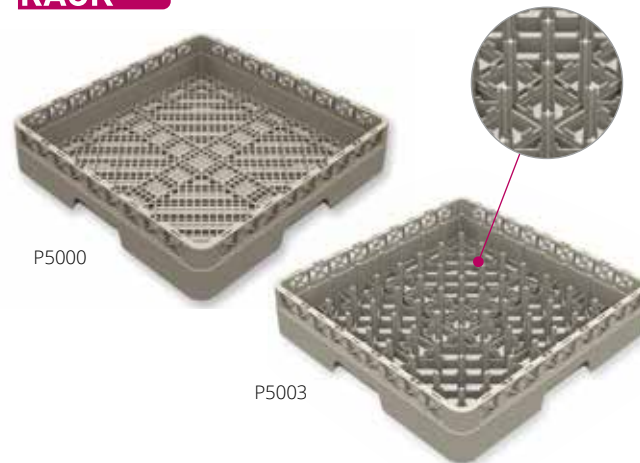

P5000 Flatware rack
Cesta para cubiertos
Panier a couverts

P5003 Plates and trays rack
Cesta para platos y bandejas
Panier pour assiettes et plateaux

| REF | €/u | |
|-------|-------|---|
| P5000 | 29,60 | 6 |
| P5003 | 29,60 | 6 |

P5062 Rack for cutlery storage
Cesta para almacenar cubiertos
Panier pour rangement couverts

FLAP RACK®

* Total set height
Altura total del conjunto
Hauteur totale ensemble



| REF | max. (mm) | H (mm)* | Cutlery capacity Capacidad cubiertos Capacité couverts | €/u | |
|-------|-----------|---------|--|--------|---|
| P5062 | 23 | 26 | 400 | 126,95 | 1 |

Complements 9.4

Complementos
Compléments



52640 8-Compartment flatware basket
Cesta para cubiertos de 8 compartimentos
Panier pour couverts 8 compartiments



NEW!

| REF | W x D x H cm | €/u | |
|-------|------------------|-------|---|
| 52640 | 46 x 19,6 x 18,5 | 46,80 | 4 |

52642 Plastic vertical flatware cylinder
Cestilla para cubiertos en plástico
Petit panier pour couverts en plastique

PI
Plastic



NEW!

| REF | Ø cm | H cm | €/u | |
|-------|-------|------|------|----|
| 52642 | 11,18 | 14,3 | 9,50 | 12 |

P5018 8-compartment flatware basket
Media cesta para cubiertos 8 compartimentos
Demi-panier pour couverts 8 compartiments

FLAP RACK®



| REF | W x D x H cm | €/u | | |
|-------|---|------------------|-------|---|
| P5018 | With handle <i>Con asa</i> Avec anse | 22 x 42,5 x 14,5 | 28,00 | 1 |
| P5019 | Without handle <i>Sin asa</i> Sans anse | 22 x 42,5 x 14,5 | 17,75 | 6 |

52641 8-Comp. flatware basket with handles
Cesta para cubiertos de 8 compart. con asas
Panier pour couverts 8 compartiments avec poignées

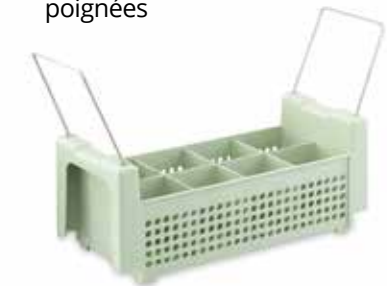

NEW!

| REF | W x D x H cm | €/u | |
|-------|------------------|-------|---|
| 52641 | 46 x 19,6 x 18,5 | 56,80 | 4 |

99710 Stainless steel vertical flatware cylinder
Cestilla para cubiertos en acero inoxidable
Petit panier pour couverts inox

SS
Stainless steel



NEW!

| REF | Ø cm | H cm | €/u | |
|-------|------|------|-------|----|
| 99710 | 11,4 | 14,1 | 33,00 | 12 |

P5004 Flatware basket
Cestillo para cubiertos
Petit panier pour couverts

PI
Plastic

FLAP RACK®



| REF | W x D x H cm | €/u | |
|-------|--------------|------|----|
| P5004 | 10 x 10 x 14 | 2,85 | 52 |
| 52643 | Ø 9,5 x 14,5 | 6,05 | 12 |

9.5 Plate racks

Cestas para platos
Casiers assiettes



FLAP RACK®

Plate crate: Perfect dish washing, storing and transporting for banquets, hotels, institutions and catering equipment rental companies. They minimize the plate breakage, labour and handling cost.

Cestas especiales para platos: Ideales para el lavado, almacenamiento y transporte de platos. Perfectas para banquetes, hoteles, colectividades y empresas de alquiler de material para la hostelería. Reducen las roturas de platos, minimizan el coste del transporte y manipulación.

Casiers pour assiettes: Idéales pour le lavage, stockage et transport d'assiettes. Parfaits pour banquetes, hôtels, collectivités et sociétés de location de matériel pour l'hôtellerie. Ce type de casiers permet de réduire le nombre d'assiettes cassées ainsi qu'une diminution des coûts de transport et manipulation.

Two types
Dos modalidades
Deux modèles

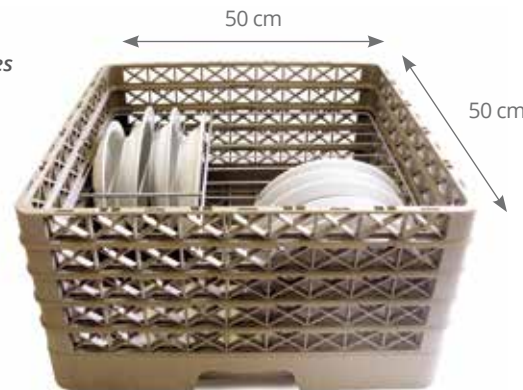

Faster wash and rinse.
Limpieza y secado rápido.
Nettoyage et séchage plus rapide.



More safety and hygienic storing and transporting.
Almacenamiento y transporte más seguro e higiénico.
Stockage et transport plus sûr et hygiénique.

Nine different grids
Nueve formatos de rejilla
Neuf grilles différentes

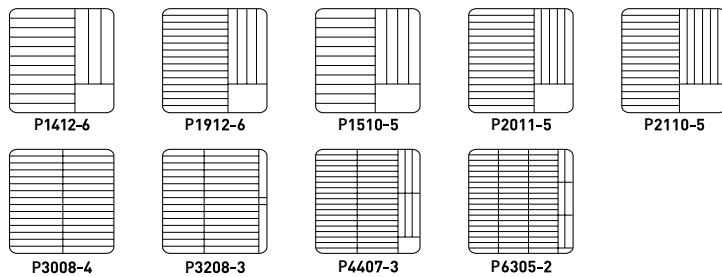

Extra protection, strength and durability.
Mayor protección, resistencia y durabilidad.
Plus grande protection, résistance et durabilité.

How to choose the appropriate plate crate:
Measure the plate diameter and height. You have then to choose between the 9 different grids according to the measures you get previously.

Como elegir la cesta de platos adecuada: Debe medir el diámetro y altura del plato. Con estos datos escoger, de las 9 combinaciones posibles, aquella que se ajuste más a las medidas del plato.

Comment choisir le casier pour assiettes: Mesurer le diamètre et la hauteur de l'assiette. Selon ces mesures choisir entre les 9 possibles combinaisons de grille qui s'adapte au mieux.



Plate racks 9.5

Cestas para platos
Casiers assiettes



P1412-6

Ø 27-31 cm

FLAP RACK

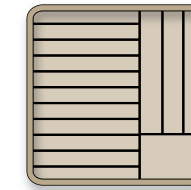

| REF | max. (cm) | Capacity plates Capacidad platos Capacité assiettes | €/u | |
|-------------|-----------|---|--------|---|
| P1412-6 | 3,5 | 14 | 178,45 | 1 |
| P1412-6 F1* | 3,5 | 14 | 215,25 | 1 |

P1912-6

Ø 28-30,5 cm

FLAP RACK

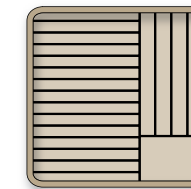

| REF | max. (cm) | Capacity plates Capacidad platos Capacité assiettes | €/u | |
|-------------|-----------|---|--------|---|
| P1912-6 | 2,5 | 19 | 178,75 | 1 |
| P1912-6 F1* | 2,5 | 19 | 222,50 | 1 |

P2110-5

Ø 23-25 cm

FLAP RACK

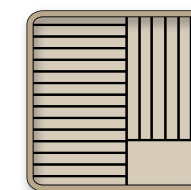

| REF | max. (cm) | Capacity plates Capacidad platos Capacité assiettes | €/u | |
|-------------|-----------|---|--------|---|
| P2110-5 | 2,5 | 21 | 139,35 | 1 |
| P2110-5 F1* | 2,5 | 21 | 154,75 | 1 |

P3208-3

Ø 12-19 cm

FLAP RACK

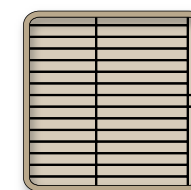

| REF | max. (cm) | Capacity plates Capacidad platos Capacité assiettes | €/u | |
|-------------|-----------|---|--------|---|
| P3208-3 | 2,5 | 32 | 132,15 | 1 |
| P3208-3 F1* | 2,5 | 32 | 151,65 | 1 |

P1510-5

Ø 23-28 cm

FLAP RACK

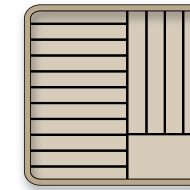

| REF | max. (cm) | Capacity plates Capacidad platos Capacité assiettes | €/u | |
|-------------|-----------|---|--------|---|
| P1510-5 | 3,5 | 15 | 168,40 | 1 |
| P1510-5 F1* | 3,5 | 15 | 198,00 | 1 |

P2011-5

Ø 25-28 cm

FLAP RACK

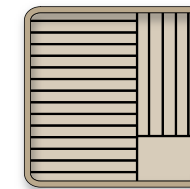

| REF | max. (cm) | Capacity plates Capacidad platos Capacité assiettes | €/u | |
|-------------|-----------|---|--------|---|
| P2011-5 | 2,5 | 20 | 169,35 | 1 |
| P2011-5 F1* | 2,5 | 20 | 201,05 | 1 |

P3008-4

Ø 20-22 cm

FLAP RACK

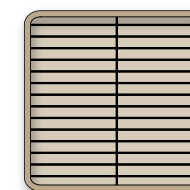

| REF | max. (cm) | Capacity plates Capacidad platos Capacité assiettes | €/u | |
|-------------|-----------|---|--------|---|
| P3008-4 | 2,5 | 30 | 131,50 | 1 |
| P3008-4 F1* | 2,5 | 30 | 147,75 | 1 |

FLAP RACK

* Closed racks
* Cestas cerradas
* Casiers fermés

Indicate the colour code at the end of the reference.
Indicar el código de color al final de la referencia.
Indiquer le code de couleur a la fin de la référence.

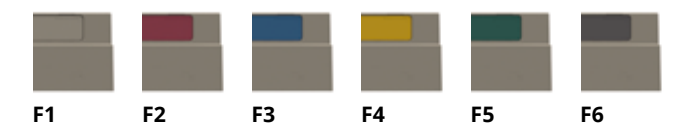

9.5 Plate racks

Cestas para platos
Casiers assiettes



P4407-3 Ø 15-18 cm

FLAP RACK

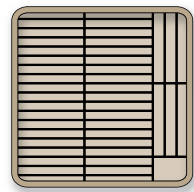

| REF | max. (cm) | Capacity plates Capacidad platos Capacité assiettes | €/u | ☐ |
|-------------|-----------|---|--------|---|
| P4407-3 | 2 | 44 | 133,80 | 1 |
| P4407-3 F1* | 2 | 44 | 151,30 | 1 |

TR23 Open tray rack
TR30 Cesta para grandes bandejas
Panier pour grands plateaux

T-VERSION



* Capacity for 4 full-size extended trays and also for isothermal trays
Ref. 919000 (page 220)
Capacidad para 4 bandejas extendidas de tamaño completo y también para bandejas isotérmicas Ref. 919000 (pag 220)
Capacité pour 4 plateaux longs de grande taille et également pour des plateaux isothermes Réf. 919000 (page 220).

| REF | H cm Inside Intérieur | H cm Outside Exterior | €/u | ☐ |
|-------|--------------------------|--------------------------|-------|---|
| TR23* | 13,3 | 13,3 | 90,10 | 1 |
| TR30 | 8,3 | 10,2 | 54,25 | 1 |

FLAP RACK

* Closed racks
* Cestas cerradas
* Paniers fermés

Indicate the colour code at the end of the reference.
Indicar el código de color al final de la referencia.
Indiquer le code de couleur a la fin de la référence.

P6305-2 Ø 10-12,8 cm

FLAP RACK

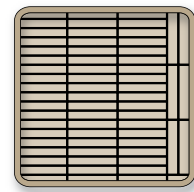

| REF | max. (cm) | Capacity plates Capacidad platos Capacité assiettes | €/u | ☐ |
|-------------|-----------|---|--------|---|
| P6305-2 | 2,5 | 63 | 133,25 | 1 |
| P6305-2 F1* | 2,5 | 63 | 151,65 | 1 |

TR21 GN, isothermal trays and plates rack
TR22 Cesta para bandejas isotérmicas, GN y platos
Panier pour plateaux isothermes, GN et assiettes

T-VERSION



TR21
8 Compartments
Distance between compart.
Distancia entre compart.
Distance entre compart

80 mm
Not suitable for isothermal trays
No aptos para bandejas isotérmicas
Ne convient pas aux bacs isothermiques
Ref. 919000 (pag 220)

TR22
5 Compartments
Distance between compart.
Distancia entre compart.
Distance entre compart

75 mm
Not suitable for isothermal trays
No aptos para bandejas isotérmicas
Ne convient pas aux bacs isothermiques
Ref. 919000 (pag 220)

Open end rack / Cesta de extremo abierto / Casier ouvert à l'extrémité

| REF | H cm Inside Intérieure | H cm Outside Exterior | €/u | ☐ |
|------|---------------------------|--------------------------|--------|---|
| TR21 | 8,3 | 12,1 | 121,45 | 1 |
| TR22 | 13,3 | 13,3 | 127,95 | 1 |

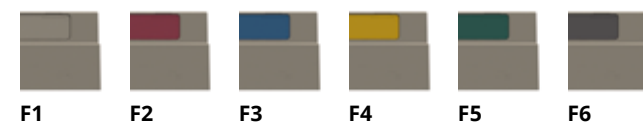

Reference guide for bases and extensions

Guía de selección para bases y extensiones
Guide de sélection pour bases et rehausses

HEIGHT OF FULL-SIZE RACKS
ALTURA DE LAS CESTAS DE TAMAÑO COMPLETO
HAUTEUR DES CASIERS GRANDE TAILLE

HEIGHT OF HALF-SIZE RACKS
ALTURA DE LAS CESTAS DE MEDIO TAMAÑO
HAUTEUR DES CASIERS DEMI-TAILLE

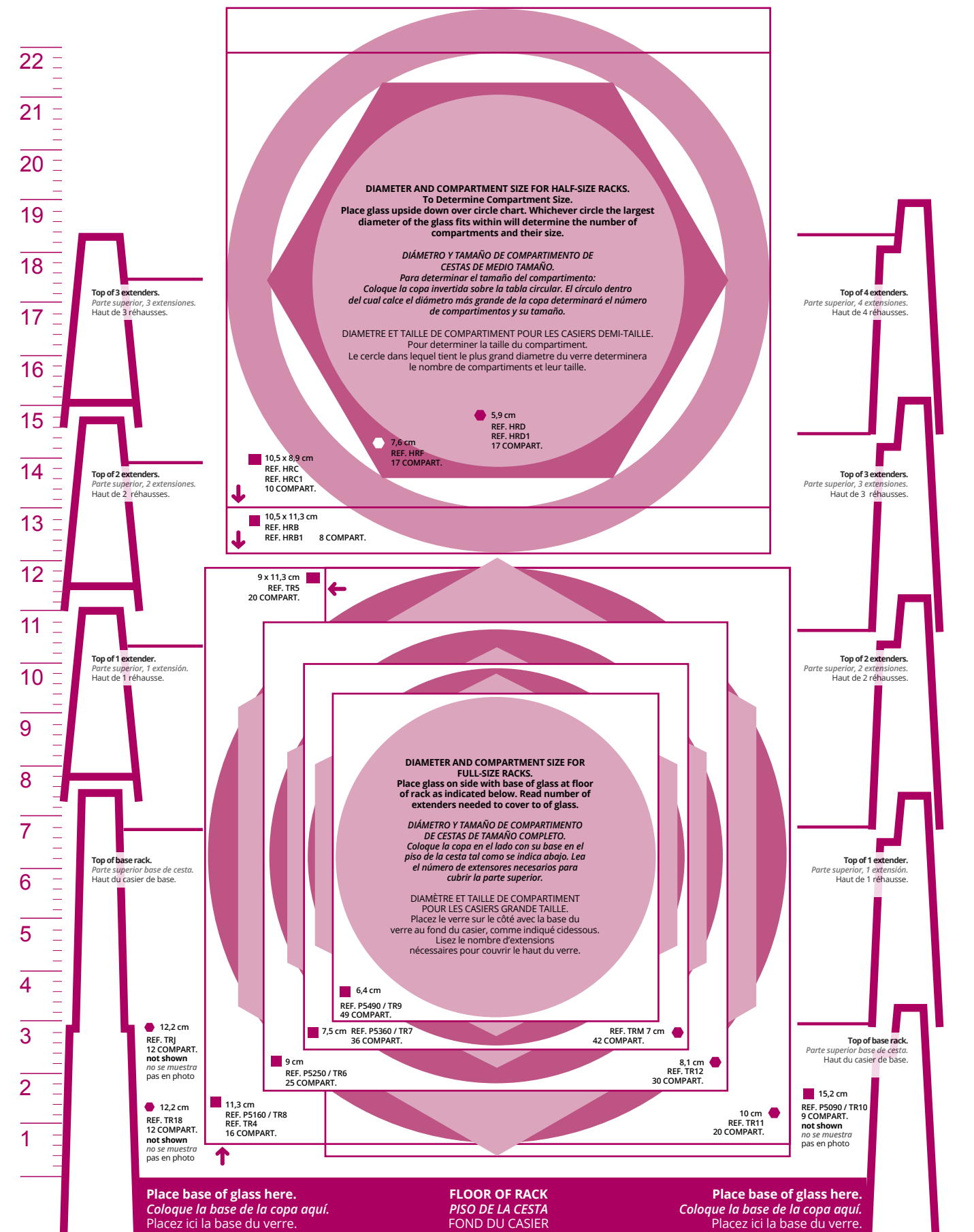

10 Trolleys

Carros
Chariots



10.1 ALUMINIUM SERVING TROLLEYS 244

CARROS DE SERVICIO ALUMINIO
CHARIOTS DE SERVICE EN ALUMINIUM

10.2 ST/STEEL SERVING TROLLEYS 246

CARROS DE SERVICIO ACERO INOXIDABLE
CHARIOTS DE SERVICE EN ACIER INOXYDABLE

10.3 ST/STEEL RAIL TROLLEYS 250

CARROS GUÍAS EN ACERO INOXIDABLE
CHARIOTS À GLISSIÈRES EN ACIER INOXYDABLE

16.4 SPECIAL TROLLEYS 257

CARROS ESPECIALES
CHARIOTS SPÉCIAUX

10.1 Aluminium serving trolleys

Carros de servicio aluminio
Chariots de service en aluminium

P6411 Multi purpose cart

Carro de servicio
Chariot de service

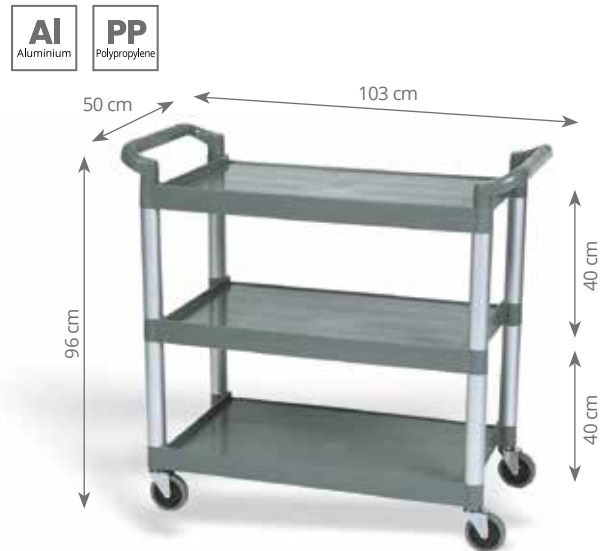

Maximum weight load 120 kgs
Carga máxima 120 kgs
Charge maximale 120 kgs

Aluminium supports
Soportes de aluminio
Supports en aluminium

| REF | Shelf dimension Dim. Estante / Dim. Niveau cm | €/u | |
|---------|---|--------|---|
| P641100 | 78 x 48,5 | 222,70 | 1 |

P640 Set trolley

Conjunto carro
Ensemble chariot

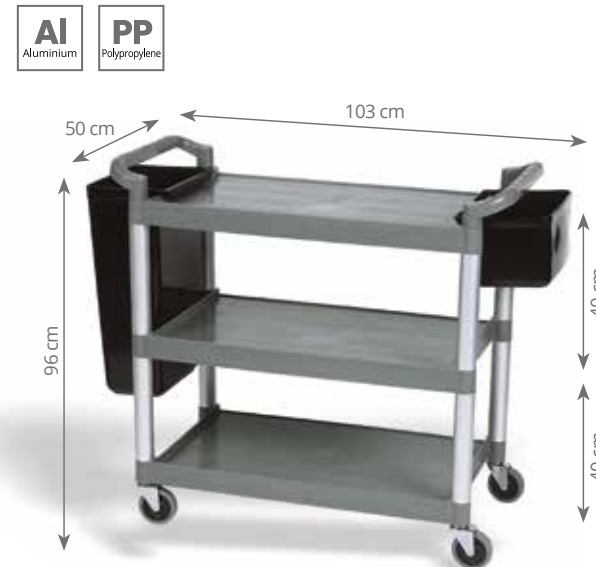

| REF | Shelf dimension Dim. Estante / Dim. Niveau cm | €/u | |
|---------|---|--------|---|
| P640000 | 78 x 48,5 | 317,25 | 1 |

P642 Silverware container

Contenedor para cubiertos
Conteneur pour couverts



| REF | cm | Lts | €/u | |
|---------|------------------|-----|-------|---|
| P642000 | 32 x 19,5 x 16,5 | 9 | 31,50 | 1 |

P643 Refuse container

Contenedor para desperdicios
Conteneur pour déchets



| REF | cm | Lts | €/u | |
|---------|----------------|-----|-------|---|
| P643000 | 33,5 x 23 x 56 | 80 | 63,05 | 1 |

Aluminium serving trolleys 10.1

Carros de servicio aluminio
Chariots de service en aluminium



97006 Multi purpose cart

Carro de servicio
Chariot de service



Textured shelf surface reduces product shifting
La superficie texturizada del estante reduce el desplazamiento del producto
La surface texturée de l'étagère réduit le déplacement du produit

Maximum weight load 135 kgs
Carga máxima 135 kgs
Charge maximale 135 kgs

| REF | Shelf dimension Dim. Estante / Dim. Niveau cm | W x D x H cm | €/u | |
|-------|---|-------------------|--------|---|
| 97006 | 66 x 41,3 | 84 x 43 x 94 | 395,00 | 1 |
| 97007 | 75 x 49 | 102,2 x 50,5 x 94 | 575,00 | 1 |

97004 Multi purpose cart

Carro de servicio
Chariot de service



Textured shelf surface reduces product shifting
La superficie texturizada del estante reduce el desplazamiento del producto
La surface texturée de l'étagère réduit le déplacement du produit

Maximum weight load 135 kgs
Carga máxima 135 kgs
Charge maximale 135 kgs

| REF | Shelf dimension Dim. Estante / Dim. Niveau cm | W x D x H cm | €/u | |
|-------|---|-------------------|--------|---|
| 97004 | 66 x 41,3 | 84 x 43 x 94 | 395,00 | 1 |
| 97005 | 75 x 49 | 102,2 x 50,5 x 94 | 575,00 | 1 |

P8090 Aluminium clearing trolley

Carro aluminio desembarace
Chariot débarrasage en aluminium

EXCLUSIVE



Racks adjustable to 1/1 GN containers and FLAP-RACK® (500 x 500 mm).
Maximum load: 150 Kg and max. per level 75 Kg.

Medidas de estantes adaptables a cubetas GN 1/1 y cestas FLAP-RACK® (500 x 500 mm). Carga máxima: total 150 Kg y con un máximo de 75 Kg por estante.

Clayettes adaptables à des bacs GN 1/1 et à casiers à vaisselle FLAP-RACK® (500 x 500 mm). Charge maximale: total 150 Kg et 75 Kg par niveau.

| REF | Shelf dimension Dim. Estante / Dim. Niveau cm | €/u | |
|--------|---|--------|---|
| P80900 | 87 x 55,5 | 409,25 | 1 |

10.2 St/steel serving trolleys

Carros de servicio acero inoxidable
Chariots de service en acier inoxydable



P8024 St/steel serving trolley

Carro servicio acero inox
Chariot service en acier inox



1.5 mm thick St/Steel tubular frame
Estructura tubular en acero inox de 1.5 mm espesor
Structure tubulaire en acier inoxydable 1.5 mm. épaisseur

Total maximum load 240 kg. Max. load per level 80 kg
Carga máxima total 240 KG.
Carga máxima por estante 80 kg
Charge maximale total 240 kg.
Charge maximale per niveau 80 kg

12 cm diam. Revolving casters. Two with brakes
Ruedas giratorias de 12 cm diámetro. Dos con frenos
Roues giratoires de 12 cm diam.
Deux avec freins



| REF | Levels Estantes Niveaux | Shelf dimension Dim. Estante / Dim. Niveau cm | W x D x H cm | €/u | 📦 |
|---------|-------------------------|---|------------------|----------|---|
| P80240 | 2 | 80 x 50 | 88 x 58 x 101,5 | 430,55 | 1 |
| P80250 | 2 | 90 x 50 | 98 x 58 x 101,5 | 503,60 | 1 |
| P80260* | 2 | 100 x 60 | 108 x 68 x 101,5 | 647,45 | 1 |
| P80270 | 3 | 80 x 50 | 88 x 58 x 101,5 | 476,20 | 1 |
| P80280 | 3 | 90 x 50 | 98 x 58 x 101,5 | 566,70 | 1 |
| P80290* | 3 | 100 x 60 | 108 x 68 x 101,5 | 681,30 | 1 |
| P80300 | 4 | 80 x 50 | 88 x 58 x 130 | 722,35 | 1 |
| P80310 | 4 | 90 x 50 | 98 x 58 x 130 | 800,10 | 1 |
| P80320* | 4 | 100 x 60 | 108 x 68 x 130 | 1.093,15 | 1 |

* Thicker shelves
Estantes de chapa de mayor espesor
Plateaux plus épais

Available also on polyamide castors.
Disponible también con ruedas poliamida.
Disponible aussi avec roulettes polyamide.



P80374 Cutlery dispenser for serving trolley

Cubertero para carro servicio
Ramasse-couverts pour chariot service



| REF | Mod | H cm | €/u | 📦 |
|--------|--------|------|-------|---|
| P80374 | GN 1/3 | 15 | 48,65 | 1 |

P8068 St/Steel clearing trolley

Carro desembarace inox
Chariot de débarrassage en inox



Available also on polyamide castors.
Disponible también con ruedas poliamida.
Disponible aussi avec roulettes polyamide.

1/2 Gastronorm container not included.
No incluye cubeta Gastronorm 1/2.
Bac Gastronorme 1/2 non inclus.
Ø 165 mm

| REF | Levels Estantes Niveaux | Shelf dimension Dim. Estante / Dim. Niveau mm | €/u | 📦 |
|--------|-------------------------|---|--------|---|
| P80680 | 2 | 1.000 x 600 | 695,05 | 1 |

St/steel serving trolleys 10.2

Carros de servicio acero inoxidable
Chariots de service en acier inoxydable



P80282 Paneled serving trolley

Carro servicio panelado
Chariot service panelé



1.5 mm thick St/Steel tubular frame
Estructura tubular en acero inox de 1.5 mm espesor
Structure tubulaire en acier inoxydable 1.5 mm. épaisseur

Paneled
Panelado
Panelé



Total maximum load 240 kg. Max. load per level 80 kg
Carga máxima total 240 kg
Carga máxima por estante 80 kg
Charge maximale total 240 kg
Charge maximale per niveau 80 kg

12 cm diam. Revolving casters. Two with brakes
Ruedas giratorias de 12 cm diámetro. Dos con frenos
Roues giratoires de 12 cm diam.
Deux avec freins

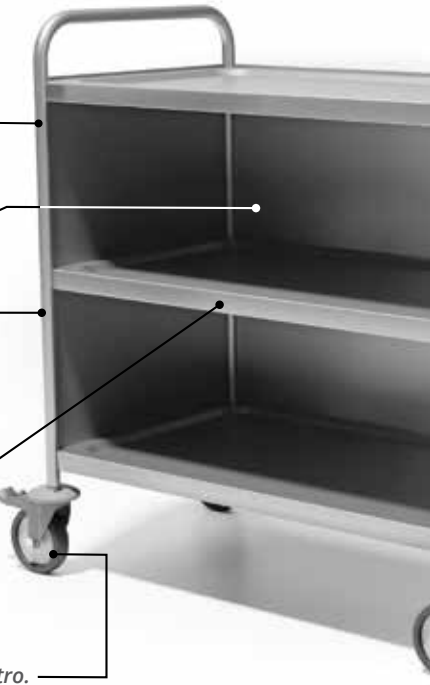

| REF | Shelf dimension Dim. Estante / Dim. Niveau cm | €/u | 📦 |
|--------|---|----------|---|
| P80282 | 90 x 50 | 1.032,70 | 1 |

97181 Bussing cart

Carro de transporte
Chariot de transport



Bins not included
Cubetas no incluidas
Bacs non inclus.

Durable stainless steel construction and ABS handle provide years of service.

La construcción duradera de acero inoxidable y el mango de ABS proporcionan años de servicio.

La construction durable en acier inoxydable et la poignée en ABS offrent des années de service.

Black vinyl finish creates an attractive appearance

El acabado de vinilo negro crea un aspecto atractivo

La finition en vinyle noir crée un look attrayant

Strong swivel casters ensure swift maneuvering

Las ruedas giratorias fuertes garantizan una maniobra rápida

Des roues pivotantes robustes garantissent une manœuvre rapide



| REF | Shelf dimension Dim. Estante / Dim. Niveau cm | €/u | 📦 |
|-------|---|----------|---|
| 97181 | 69 x 45 | 1.361,00 | 1 |

10.2 St/steel serving trolleys

Carros de servicio acero inoxidable
Chariots de service en acier inoxydable



**Total maximum load 240 kg.
Max. load per level 80 kg**

Carga máxima total 240 KG.
Carga máxima por estante 80 kg
Charge maximale total 240 kg.
Charge maximale per niveau 80 kg

12 Cm diam. Revolving casters. Two with brakes
Ruedas giratorias de 12 cm diámetro. Dos con frenos
Roues giratoires de 12 cm diam. Deux avec freins



P8033 Disassembled trolley
Carro desmontable
Chariot démontable



ASSEMBLY
MONTAJE
MONTAGE

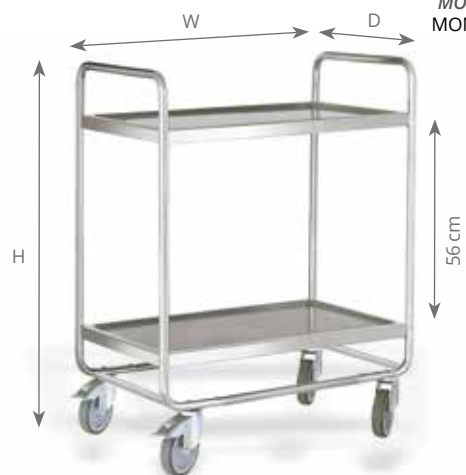

Muy robustos y sólidos
Very strong and resistant once assembled
Très robustes et solides une fois montés

Se entregan desmontados.
Delivered flatpacked.
Livrés démontés.

| REF | Levels Estantes Niveaux | Shelf dimension Dim. Estante Dim. Niveau cm | W x D x H cm | €/u | 📦 |
|--------|-------------------------------|--|-----------------|--------|---|
| P80330 | 2 | 80 x 50 | 81 x 54,5 x 104 | 478,95 | 1 |
| P80340 | 2 | 90 x 50 | 91 x 54,5 x 104 | 555,10 | 1 |
| P80350 | 3 | 80 x 50 | 81 x 54,5 x 104 | 564,25 | 1 |
| P80360 | 3 | 90 x 50 | 91 x 54,5 x 104 | 668,95 | 1 |

P8096 Light disassembled trolley
Carro desmontable ligero
Chariot démontable légère



Ruedas acero Ø 100 mm. Dos con freno.
Castors Ø 100 mm. Two with brakes.
Roulettes Ø 100 mm. Deux avec freins.

**ECONOMIC LINE
GAMA ECONÓMICA
GAMME ECONOMIQUE**

| REF | Levels Estantes Niveaux | Shelf dimension Dim. Estante Dim. Niveau cm | W x D x H cm | €/u | 📦 |
|--------|-------------------------------|--|-----------------|--------|---|
| P80960 | 2 | 83 x 51 | 93 x 61 x 93,5 | 213,10 | 1 |
| P80961 | 3 | 83 x 51 | 93 x 61 x 93,5 | 254,45 | 1 |

St/steel serving trolleys 10.2

Carros de servicio acero inoxidable
Chariots de service en acier inoxydable



P8094 Serving trolley with guard-rail shelf
Carro servicio con barandilla
Chariot service avec galerie

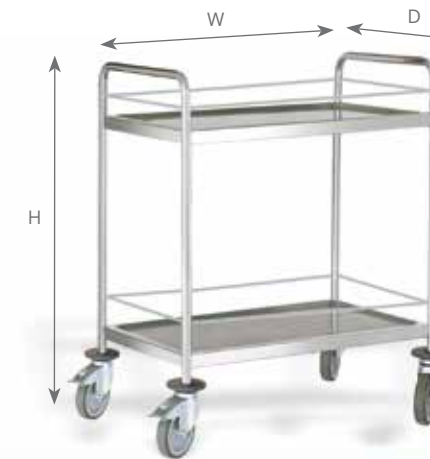

Available also on polyamide castors. Please ask for price
Disponible también con ruedas poliamida. Consultar precio
Disponible aussi avec roulettes polyamide. Consulter prix

| REF | Levels Estantes Niveaux | Shelf dimension Dim. Estante Dim. Niveau cm | W x D x H cm | €/u | 📦 |
|--------|-------------------------------|--|-----------------|--------|---|
| P80940 | 2 | 80 x 50 | 88 x 58 x 101,5 | 480,80 | 1 |
| P80941 | 3 | 80 x 50 | 88 x 58 x 101,5 | 632,75 | 1 |

97168 Three-shelf tubular cart
Carro tubular de 3 estantes
Chariot tubulaire à 3 étagères



NEW!

97208 Three-shelf heavy-duty stainless steel cart
Carro de servicio de 3 niveles
Chariot service à trois étagères



NEW!

**400 kg capacity is distributed between the shelves.
Two 10 cm wivel casters and two 20 cm front wheels
ensure swift maneuvering.
Extended-height stainless steel handles feature a comfort
coating.**

La capacidad de 400 kg se distribuye entre las estanterías.
Dos ruedas giratorias de 10 cm y dos ruedas delanteras de 20
cm garantizan una maniobra rápida. Los mangos de acero
inoxidable de altura extendida cuentan con un revestimiento de
comfort.

La capacité de 400 kg est répartie entre les rayonnages. Deux
roues pivotantes de 10 cm et deux roues avant de 20 cm
garantissent une manœuvre rapide. Les poignées en acier
inoxidable à hauteur prolongée sont dotées d'un revêtement de
comfort.

| REF | Shelf dimension Dim. Estante Dim. Niveau cm | €/u | 📦 |
|-------|--|----------|---|
| 97208 | 89 x 58,4 | 2.715,00 | 1 |

| REF | Shelf dimension Dim. Estante Dim. Niveau cm | €/u | 📦 |
|-------|--|----------|---|
| 97168 | 85 x 54 | 1.770,00 | 1 |

10.3 St/steel rail trolleys

Carros guías en acero inoxidable
Chariots à glissières en acier inoxydable



P8043 17 rails trolley for GN pans
Carro 17 guías GN
Chariot 17 glissières pour bacs GN



Available also on polyamide castors. Please ask for price.
Disponibile también con ruedas poliamida. Consultar precio.
Disponible aussi avec roulettes polyamide. Consulter prix.

| REF | Entrance / Entrada / Entré cm | € / u | |
|--------|----------------------------------|--------|---|
| P80430 | 32,5 | 662,60 | 1 |

P8067 Double rail trolley 17 x 2 for 1/1 GN pans
Carro doble 17 x 2 guías 1/1
Chariot double 17 x 2 glissières pour bacs GN 1/1



Available also on polyamide castors. Please ask for price.
Disponibile también con ruedas poliamida. Consultar precio.
Disponible aussi avec roulettes polyamide. Consulter prix.

| REF | Entrance / Entrada / Entré cm | € / u | |
|--------|----------------------------------|----------|---|
| P80670 | 32,5 | 1.125,05 | 1 |

P80641 Disposable trolley covers dispenser
Dispensador para fundas de carro
Distributeur pour housses de chariot



| REF | € / u | |
|--------|-------|---|
| P80641 | 83,00 | 1 |

P8061 Disposable covers for trolleys
P8062 Fundas desechables de polietileno para carros
P8063 Housses jetables pour chariots



Pack / Rollo / Rouleau 100 u

Medium density polyethylene. Para high trolleys.
Polietileno de densidad media. Para carros altos.
Poliéthylène de densité moyenne. Pour chariots hauts.

| REF | € / u | |
|---|--------|---|
| P80610 for trolley 1/1 / para carro 1/1 / pour chariot 1/1 | 211,20 | 1 |
| P80620 for trolley 2/1 / para carro 2/1 / pour chariot 2/1 | 237,80 | 1 |
| P80630 for pastry trolley 600 x 400 / para carro pastelería 600 x 400 / pour chariot pâtisserie 600 x 400 | 214,55 | 1 |

St/steel rail trolleys 10.3

Carros guías en acero inoxidable
Chariots à glissières en acier inoxydable



P8047 Disassembled trolley 17 rails for GN pans
Carro desmontable 17 guías GN
Chariot démontable 17 glissières pour bacs GN



Available also on polyamide castors. Please ask for price.
Disponibile también con ruedas poliamida. Consultar precio.
Disponible aussi avec roulettes polyamide. Consulter prix.

| REF | Entrance / Entrada / Entré cm | € / u | |
|--------|----------------------------------|--------|---|
| P80470 | 32,5 | 612,30 | 1 |

P8097 Light Disassembled trolley 15 rails for GN pans
Carro desmontable ligero 15 guías GN
Chariot démontable léger 15 glissières pour bacs GN



Castors Ø 120 mm. Two with brakes.
Ruedas acero Ø 120 mm. Dos con freno.
Roulettes Ø 120 mm. Deux avec freins.

ECONOMIC LINE
GAMA ECONÓMICA
GAMME ECONOMIQUE

| REF | Entrance / Entrada / Entré cm | € / u | |
|--------|----------------------------------|--------|---|
| P80970 | 32,5 | 461,60 | 1 |

P8052 Stackable trolley 17 rails for GN pans
Carro encastrable 17 guías GN
Chariot emboîtable 17 glissières pour bacs GN



Stackble
Encastrable
Emboîtable

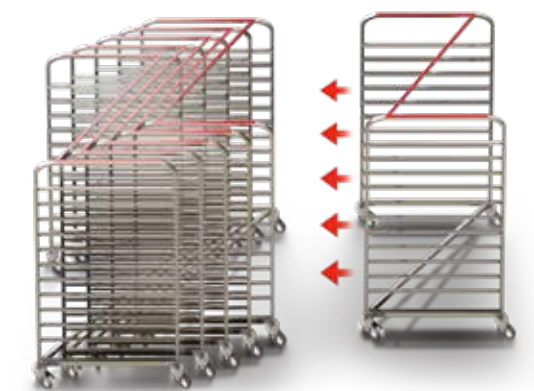

Available also on polyamide castors. Please ask for price.
Disponibile también con ruedas poliamida. Consultar precio.
Disponible aussi avec roulettes polyamide. Consulter prix.

| REF | Entrance / Entrada / Entré cm | € / u | |
|--------|----------------------------------|--------|---|
| P80520 | 32,5 | 751,55 | 1 |

10.3 St/steel rail trolleys

Carros guías en acero inoxidable
Chariots à glissières en acier inoxydable



P8044 17 rails trolley for GN pans
Carro 17 guías GN
Chariot 17 glissières pour bacs GN



Available also on polyamide castors. Please ask for price.
Disponible también con ruedas poliamida. Consultar precio.
Disponible aussi avec roulettes polyamide. Consulter prix.

| REF | Entrance / Entrada / Entré cm | € / u | |
|--------|----------------------------------|--------|---|
| P80440 | 53 | 677,10 | 1 |

P8048 Disassembled trolley 17 rails for GN pans
Carro desmontable 17 guías GN
Chariot démontable 17 glissières pour bacs GN



Available also on polyamide castors. Please ask for price.
Disponible también con ruedas poliamida. Consultar precio.
Disponible aussi avec roulettes polyamide. Consulter prix.

| REF | Entrance / Entrada / Entré cm | € / u | |
|--------|----------------------------------|--------|---|
| P80480 | 53 | 625,80 | 1 |

P8051 Stackable trolley 17 rails for GN pans
Carro encastrable 17 guías GN
Chariot emboîtable 17 glissières pour bacs GN



Available also on polyamide castors. Please ask for price.
Disponible también con ruedas poliamida. Consultar precio.
Disponible aussi avec roulettes polyamide. Consulter prix.

| REF | Entrance / Entrada / Entré cm | € / u | |
|--------|----------------------------------|--------|---|
| P80510 | 53 | 808,05 | 1 |

St/steel rail trolleys 10.3

Carros guías en acero inoxidable
Chariots à glissières en acier inoxydable



P8084 Pastry trolley
P8085 Carro pastelería
P8046 Chariot pâtisserie



Entrance 400 mm
Entrada 400 mm
Entrée 400 mm

Available also on polyamide castors. Please ask for price.
Disponible también con ruedas poliamida. Consultar precio.
Disponible aussi avec roulettes polyamide. Consulter prix.

| REF | Nr. of Levels Nº Guías Num. Niveaux | Size of rails Medida guías Dim. glissières cm | Distance between levels Distancia entre guías Espace entre niveaux cm | € / u | |
|--------|---|--|--|--------|---|
| P80840 | 15 | 60 x 40 | 8,5 | 669,85 | 1 |
| P80850 | 20 | 60 x 40 | 7,0 | 689,50 | 1 |
| P80460 | 30 | 60 x 40 | 4,5 | 729,85 | 1 |

P8087 Disassembled rail trolley for bakery
P8088 Carro desmontable bandejas pastelería
P8050 Chariots démontable pour plaques à pâtisserie



Entrance 400 mm
Entrada 400 mm
Entrée 400 mm

Available also on polyamide castors. Please ask for price.
Disponible también con ruedas poliamida. Consultar precio.
Disponible aussi avec roulettes polyamide. Consulter prix.

| REF | Nr. of Levels Nº Guías Num. Niveaux | Size of rails Medida guías Dim. glissières cm | Distance between levels Distancia entre guías Espace entre niveaux cm | € / u | |
|--------|---|--|--|--------|---|
| P80870 | 15 | 60 x 40 | 8,5 | 636,45 | 1 |
| P80880 | 20 | 60 x 40 | 7,0 | 655,05 | 1 |
| P80500 | 30 | 60 x 40 | 4,5 | 693,45 | 1 |

See products on / Ver productos en / Voir produits en page

P. 154

GN Pastry Pan
Cubeta GN Pastelería
Bac GN pâtisserie



10.3 St/steel rail trolleys

Carros guías en acero inoxidable
Chariots à glissières en acier inoxydable



P8081 Defrost trolley 9 rails
Carro descongelación 9 guías
Chariot à dégivrage 9 glissières

PATENTED EXCLUSIVE



Drain in each shelf
Cada nivel tiene un desagüe
Chaque niveau est pourvu d'une évacuation

Tray to collect thawing condensate
Cubeta para recoger el agua de descongelación
Bac pour recueillir l'eau de décongélation

Space saver while foodstuff defrost.
Ahorro de espacio en el proceso de descongelado de los alimentos.
Economie d'espace pendant le dégivrage des aliments.
Available also on polyamide castors. Please ask for price.
Disponible también con ruedas poliamida. Consultar precio.
Disponible aussi avec roulettes polyamide. Consulter prix.

| REF | Mod | W x D x H cm | Entrance Entrada Entré cm | €/u | |
|--------|--------|-------------------|---------------------------|----------|---|
| P80810 | GN 2/1 | 66,5 x 75,5 x 171 | 53,0 | 1.207,80 | 1 |
| P80813 | GN 1/1 | 45,5 x 63,0 x 171 | 32,5 | 1.180,20 | 1 |

P80811 Special GN container for defrost trolley
Cubeta especial GN para carro descongelación
Bac GN spécial pour chariot dégivrage



Container with drainer hole.
Cubeta con desagüe.
Bac avec dégorgeement.

| REF | Mod | cm | Lts | H cm | €/u | |
|--------|--------|-----------|------|------|--------|---|
| P80811 | GN 2/1 | 65 x 53 | 28,9 | 10 | 112,30 | 1 |
| P80814 | GN 1/1 | 53 x 32,5 | 14,2 | 10 | 55,85 | 1 |

P215 / P115 Perforated bottom
Fondo perforado para cubeta
Egouttoir pour bac



¹ Recommended for item code P80811
Recomendado para ref. P80811
Recommandé pour réf. P80811
² Recommended for item code P80814
Recomendado para ref. P80814
Recommandé pour réf. P80814

| REF | Mod | €/u | |
|----------------------|--------|-------|---|
| P215000 ¹ | GN 2/1 | 82,70 | 1 |
| P115000 ² | GN 1/1 | 40,70 | 1 |

St/steel rail trolleys 10.3

Carros guías en acero inoxidable
Chariots à glissières en acier inoxydable



P8095 Self-service trolley 12 rails
Carro self-service 12 guías
Chariot self-service 12 glissières

P8096 Self-service trolley 24 rails
Carro self-service 24 guías
Chariot self-service 24 glissières

NEW!

New 12 cm width rails
Nuevas guías de 12 cm de ancho
Nouveaux rails de 12 cm de large

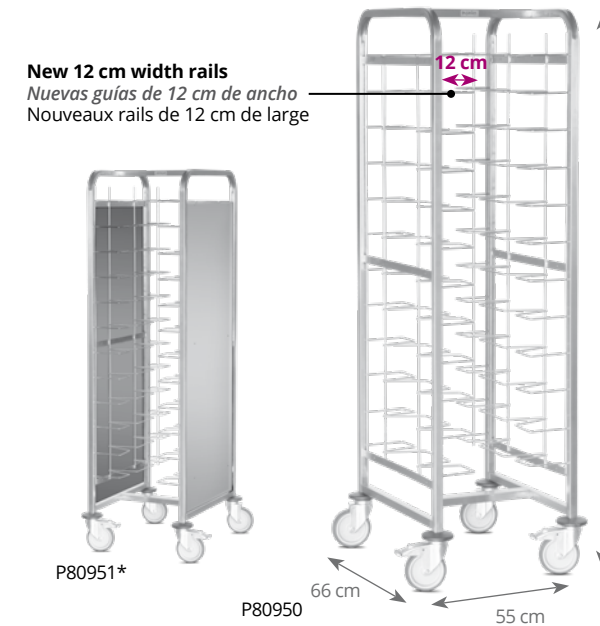

* With two side panels made of aluminium+composite.
* Con dos paneles laterales composite+aluminio.
* Avec deux panneaux latéraux en composite+aluminium.

| REF | €/u | |
|---------|----------|---|
| P80950 | 740,20 | 1 |
| P80951* | 1.047,40 | 1 |

* With two side panels made of aluminium+composite.
* Con dos paneles laterales composite+aluminio.
* Avec deux panneaux latéraux en composite+aluminium.



| REF | €/u | |
|---------|----------|---|
| P80965 | 1.244,45 | 1 |
| P80966* | 1.533,00 | 1 |

* With two side panels made of aluminium+composite.
* Con dos paneles laterales composite+aluminio.
* Avec deux panneaux latéraux en composite+aluminium.

See products on / Ver productos en / Voir produits en page

P. 222

Polypropylene fast food trays
Bandejas de polipropileno para comida rápida
Plateaux de restauration rapide en polypropylène



10.3 St/steel rail trolleys

Carros guías en acero inoxidable
Chariots à glissières en acier inoxydable



P8091 Double fast-food tray trolley 12 rails
Carro doble para bandejas fast-food 12 guías
Chariot double pour plateaux fast-food 12 glissières



Suitable for trays 480 x 370 mm
Ideal para bandejas 480 x 370 mm
Ideal pour plateaux 480 x 370 mm

Entrance 480 mm
Entrada 480 mm
Entrée 480 mm

Available also on polyamide castors. Please ask for price.
Disponibile también con ruedas poliamida. Consultar precio.
Disponible aussi avec roulettes polyamide. Consulter prix.

| REF | Size of rails Medida guías Dimensions glissières cm | €/u | |
|--------|--|--------|---|
| P80910 | 48 x 80 | 803,70 | 1 |

P925 Transport trolley for isothermal trays
Carro transporte bandejas isotérmicas
Chariot transport plateaux isothermes



Trolley made of St/Steel and plastic rails. Perfect for many different size trays transport thanks to the special rail design. Soundproof revolving castors Ø 125 mm.

Carro fabricado en acero inoxidable y guías de plástico. Ideal para el transporte de bandejas de distintas medidas, gracias al diseño especial de sus guías. Ruedas giratorias insonoras de Ø 125 mm.

Chariot fabriqué en acier inoxydable et glissières en plastique. Idéal pour le transport des plateaux de différentes mesures, grâce au design spécial des glissières. Roulettes insonores de Ø 125 mm.

| REF | Nr. of Levels Nº Guías Num. Niveaux | Size of rails Medida guías Dim. glissières cm | W x D x H cm | €/u | |
|---------|---|--|-----------------|----------|---|
| P925001 | 10 | 55 x 37,5 | 50 x 62 x 152 | 1.093,65 | 1 |
| P925002 | 20 | 55 x 37,5 | 92 x 62 x 152 | 1.461,90 | 1 |

See products on / Ver productos en / Voir produits en page

P. 220

Isothermal tray
Bandeja isotérmica
Plateau Isotherme



Special trolleys 10.4

Carros especiales
Chariots spéciaux



P80790 Plate trolley
Carro para platos
Chariot à vaisselle



| REF | W x D x H cm | €/u | |
|--------|-----------------|--------|---|
| P80790 | 58 x 71 x 177,5 | 980,00 | 1 |

The distance between levels is 5,8 cm
Distancia entre niveles 5,8 cm.
Distance entre les niveaux 5,8 cm.

Carbon steel with anti-corrosion coating
Acero al carbono con recubrimiento anticorrosivo
Acier au carbone avec revêtement anti-corrosion

Capacity for 100 dishes. Different sizes of dishes can be combined thanks to its adjustable system.

Capacidad para 100 platos. Se pueden combinar diferentes tamaños de platos gracias a su sistema ajustable.

Capacité pour 100 assiettes. Différentes tailles de plats peuvent être combinées grâce à son système réglable.

(Ø máx. 34,5cm)

Strong welded structure handle for easy transport

Resistente estructura soldada con asa para fácil transporte.

Structure soudée robuste avec poignée pour un transport facile.

4 Wheels of 125mm with bumpers. 2 wheels brakes included.

4 ruedas de 12,5 cm con parachoques. 2 ruedas con freno.

4 roues de 125 mm avec pare-chocs. 2 roulettes avec freins

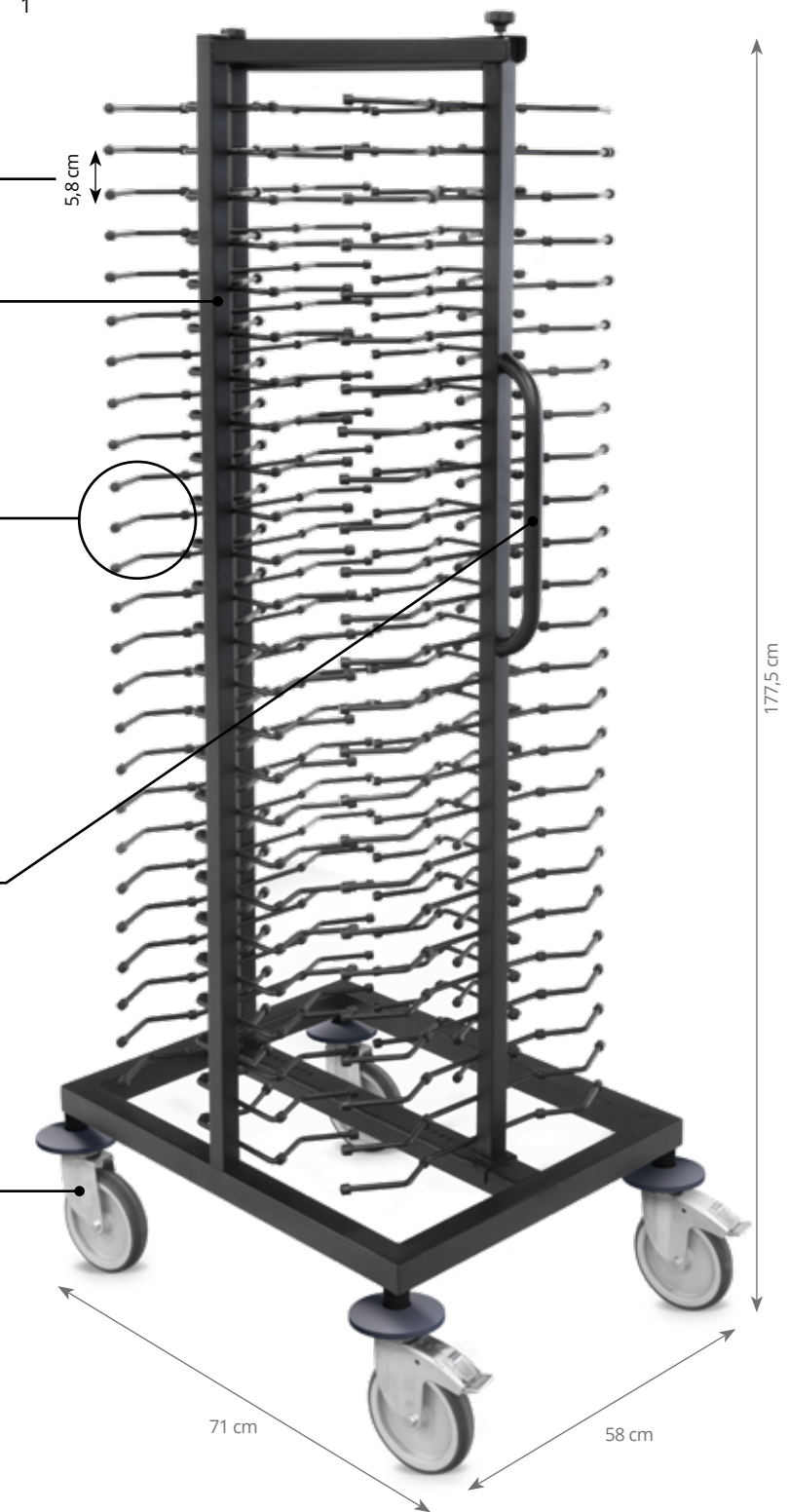

10.4 Special trolleys

Carros especiales
Chariots spéciaux



P8039 GN containers transport trolley
Carro porta cubetas GN
Chariot transport bacs GN



GN containers not included.
No incluye cubetas GN.
Bacs GN non inclus.

Available also on polyamide castors. Please ask for price.
Disponible también con ruedas poliamida. Consultar precio.
Disponible aussi avec roulettes polyamide. Consulter prix.

| REF | € / u | |
|--------|--------|---|
| P80390 | 620,00 | 1 |

P8038 2/1 GN transport trolley
Carro porta cubeta GN 2/1
Chariot transport bac GN 2/1



GN containers not included.
No incluye cubetas GN.
Bacs GN non inclus.

Available also on polyamide castors. Please ask for price.
Disponible también con ruedas poliamida. Consultar precio.
Disponible aussi avec roulettes polyamide. Consulter prix.

REF. P80.390 / P80.380
Transport trolley for GN containers
Carro transporte para cubetas GN
Chariots de transport pour bacs GN

Made of St/Steel. Perfect for storing and transporting large quantities of prepared food and sauces.

Fabricados en acero inoxidable. Ideales para el almacenaje y transporte de alimentos preparados y salsas en grandes cantidades.
Fabriqués en acier inoxydable. Idéales pour le stockage et le transport d'aliments cuisinés et sauces en grandes quantités.

| REF | € / u | |
|--------|--------|---|
| P80380 | 559,10 | 1 |

P8074 Trolley cutlery dispenser GN 1/3
Carro portacubiertos GN 1/3 y porta bandejas
Chariot porte-ramasse couverts GN 1/3



GN containers not included.
No incluye cubetas GN.
Bacs GN non inclus.

Available also on polyamide castors. Please ask for price.
Disponible también con ruedas poliamida. Consultar precio.
Disponible aussi avec roulettes polyamide. Consulter prix.

| REF | € / u | |
|--------|--------|---|
| P80740 | 508,80 | 1 |

P8054 Tray transport trolley 7 rails
Carro transporte bandejas 7 guías
Chariot transport plateaux 7 glissières



Ref. P80.540 Ref. P80.780

Available also on polyamide castors. Please ask for price.
Disponible también con ruedas poliamida. Consultar precio.
Disponible aussi avec roulettes polyamide. Consulter prix.

| REF | Size of rails Medida guías Dim. glissières cm | W x D x H cm | Dist. between levels Distancia entre guías Espace entre niveaux cm | € / u | |
|--------|--|------------------|---|--------|---|
| P80540 | GN 1/1 | 45,5 x 63,5 x 90 | 7,5 | 526,90 | 1 |
| P80550 | GN 2/1 | 66 x 75 x 90 | 7,5 | 590,65 | 1 |
| P80560 | Pastry Pastelería Pâtisserie (60 x 40 cm) | 52,5 x 70 x 90 | 8,5 | 574,70 | 1 |
| P80780 | GN 1/1 Doble | 81 x 63,5 x 90 | 7,5 | 974,75 | 1 |

Special trolleys 10.4

Carros especiales
Chariots spéciaux



P8075 Dishwasher rack trolley
P8076 Carro para cestas Vajillas
P8077 Chariot casiers à vaisselle



| REF | Nr. of Levels Nº Guías Num. Niveaux | Size of rails Medida guías Dim. glissières cm | W x D x H cm | € / u | |
|--------|---|--|--------------------|----------|---|
| P80750 | 5 | 50 x 50 | 64 x 63,3 x 116 | 506,80 | 1 |
| P80760 | 9 | 50 x 50 | 64 x 63,3 x 171 | 774,30 | 1 |
| P80770 | 9 | 50 x 50 | 118,5 x 63,3 x 171 | 1.034,20 | 1 |

(double / doble)

P8057 Trolley for heavy loads
Carro para cargas pesadas
Chariot à charges lourdes

Maximum load: 350 kg
Carga máxima: 350 kg
Charge maximale: 350 kg



| REF | € / u | |
|--------|--------|---|
| P80570 | 751,10 | 1 |

P8058 St/steel trolley for dishwasher racks
P8059 Carro inox para cestas
Chariot inox pour casiers à vaisselle



| REF | H cm | | € / u | |
|--------|-------|--------------------------------------|--------|---|
| P80590 | 16,5 | without handle / sin asa / sans anse | 287,75 | 1 |
| P80580 | 106,5 | with handle / con asa / avec anse | 403,40 | 1 |

10.4 Special trolleys

Carros especiales
Chariots spéciaux



P5015 Plastic trolley for dishwasher racks
Carro de plástico para cestas
Chariot pour casiers à vaisselle

Without handle
Sin asa
Sans anse



| REF | H cm | € / u | |
|-------|------|--------|---|
| P5015 | 23 | 107,85 | 1 |

P5017 Plastic trolley with handle for dishwasher racks
Carro de plástico con asa para cestas
Chariot avec anse pour casiers à vaisselle

With handle
Con asa
Avec anse



| REF | H cm | € / u | |
|-------|------|--------|---|
| P5017 | 98 | 167,70 | 1 |

1697 Plastic trolley for dishwasher racks
Carro de plástico para cestas
Chariot pour casiers à vaisselle

Without handle
Sin asa
Sans anse



| REF | Ø cm | H cm | € / u | |
|------|------|------|--------|---|
| 1697 | 1,4 | 8,7 | 127,10 | 1 |

52291 Dishwasher rack insert or cover
Tapa o inserto para cestas
Couvercle or inserto pour casiers à vaisselle



| REF | € / u | |
|-------|--------|---|
| 52291 | 109,00 | 1 |

Special trolleys 10.4

Carros especiales
Chariots spéciaux



ADC-4 Adjustable dish caddy
Carro ajustable para platos
Chariot modulable pour assiettes



Delivered with 4 posts plus 1 protection cover.
Se sirve con 4 columnas separadoras más una funda protectora.
Livré avec 4 colonnes de séparation et 1 housse de protection.

Unique and easy adjustment from the top.
Ajuste único y fácil por la parte superior.
Reglage unique et facile de la partie supérieure.

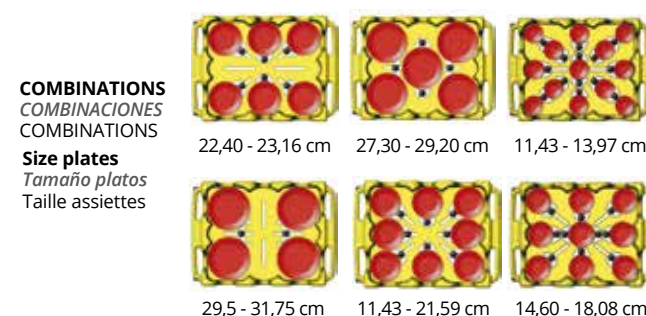

| REF | € / u | |
|-------|----------|---|
| ADC-4 | 1.499,00 | 1 |

ADP Post for dish trolley
Columna separadora carro platos
Colonne séparation chariot assiettes



Compatible ref. ADC-4
Compatible ref. SAC-SQ5-06

| REF | € / u | |
|-----|-------|---|
| ADP | 85,50 | 1 |

SAC-SQ5-06 Adjustable caddy for square & round dishes
Carro ajustable para platos cuadrados y redondos
Chariot modulable pour assiettes carrées et rondes



Unique, stackable design.
Diseño exclusivo apilable.
Design exclusif empilable.

Delivered with 5 posts, one of them in cross shape plus 1 protection cover.
Se sirve con 5 columnas separadoras una de ellas en forma de cruz más una funda protectora.

Livré avec 5 colonnes de séparation une desquelles en forme de croix plus 1 housse de protection.

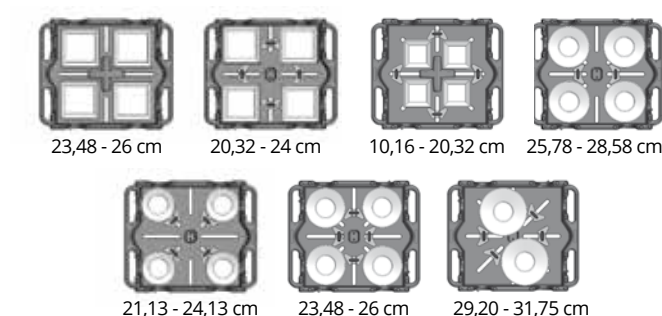

| REF | € / u | |
|------------|----------|---|
| SAC-SQ5-06 | 1.298,00 | 1 |

SAVC Vinyl cover for dish trolley
Funda protectora de vinilo para carro platos
Housse protection en vynil pour chariot assiettes



Cover for item SAVC. Funda para ref. ADC-4
Housse pour réf. SAC-SQ5-06

| REF | € / u | |
|------|--------|---|
| SAVC | 116,45 | 1 |

11 Shelving

Estanterías
Rayonnages



11.1 COMPLETE AND ANGULAR SHELVING 267

ESTANTERÍAS COMPLETAS Y ANGULARES
RAYONNAGES COMPLETS ET ANGULAIRES

11.2 SHELVING WITH WHEELS 274

ESTANTERÍAS CON RUEDAS
RAYONNAGES AVEC ROUES

11.3 BENCH 274

BANCADAS
BANCS

11.4 PARTS 275

COMPONENTES
COMPOSANTS

11.5 BREAKDOWN OF SHELVING SETS 278

DESGLOSE CONJUNTOS DE ESTANTERÍAS
DÉCOMPOSITION KITS RAYONNAGES

Modular shelving

Estanterías modulares
Rayonnages modulables

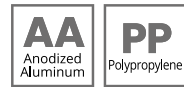

-30 °C
+75 °C

Easy and quick assembly
Facilidad y rapidez de montaje
Montage facile et rapide



ANTICORROSIVE - Manufactured with special anodised aluminium

ANTICORROSIÓN - Fabricadas con estructura de aluminio anodizado

ANTI-CORROSION - Fabriqué avec une structure fabriquée en aluminium anodisé

Robustness and resistance

Robustez y resistencia
Robustesse et résistance



Compatibility
Compatible
Compatibilité
GN 1/1 & 2/3



Rack shelves

Parrillas
Clayettes

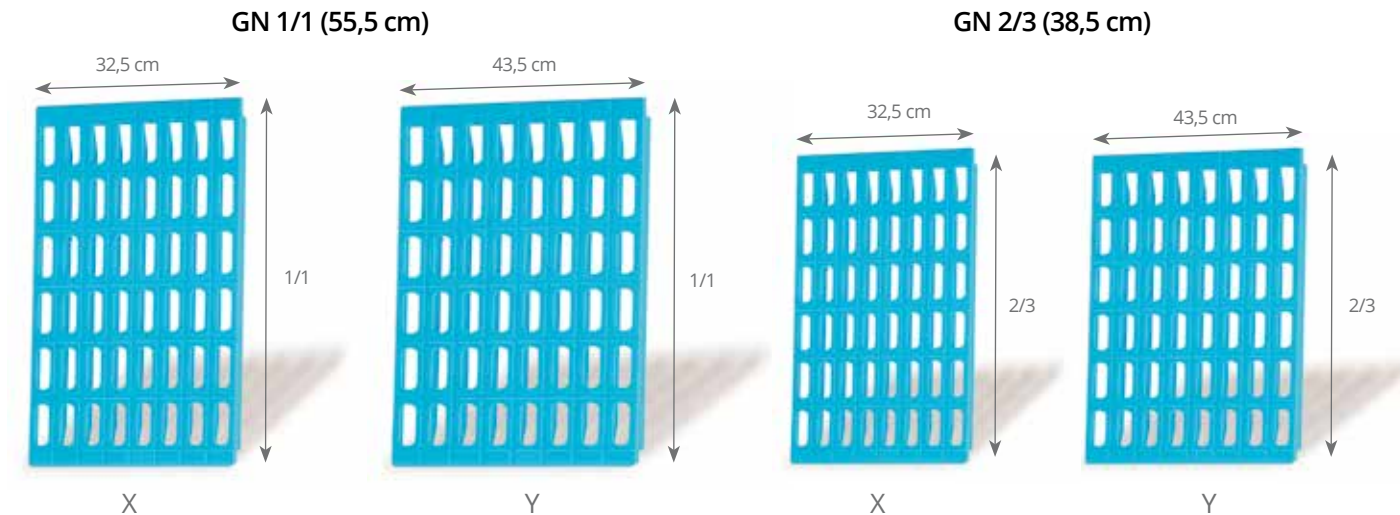

Dishwasher safe
Apto para lavavajillas
Apte pour lave-vaisselle

Combining rack shelves among the same group (X/Y) allows to personalize the lengths of each shelf. (Refer to next page for proposed combinations)

Combinando parrillas de la misma profundidad (X/Y) permite personalizar las longitudes de las estanterías a cada una de las necesidades. (Ver en página siguiente combinaciones propuestas)

En combinant des clayettes de la même profondeur (X/Y) permet de personnaliser les longueurs des rayonnages à tout besoin. (Voir page suivante pour des combinaisons proposées)

Support for crossbars

Pieza soporte travesaños
Support pour longerons



Special fixing system support for crossbars which offers the highest security, reliability and robustness.

Sistema especial de fijación de soporte para travesaños que ofrece la máxima seguridad, fiabilidad y robustez.

Système spécial de fixation des supports pour longerons qui offre la sécurité, fiabilité et robustesse maximale.

Adjustable feet

Pies regulables
Pieds réglables

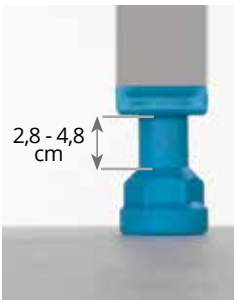

Levelling feet with hidden thread, for gradient floors. It is also possible to adapt Ø 12,5 cm wheels.

Pies regulables con rosca oculta para suelos con desniveles. Con la posibilidad de adaptar ruedas de Ø 12,5 cm.

Pieds réglables avec filetage caché pour sols irréguliers. Il est aussi possible d'y adapter des roues de Ø 12,5 cm.



Modular shelving

Estanterías modulares
Rayonnages modulables

Standard heights of levels

Alturas estándar de los niveles
Hauteur standard des niveaux

Higher than 200 cm please ask

Más de 200 cm altura consultar

Hauteur supérieure à 200 cm veuillez nous consulter

Height 175 cm / 3 levels
Altura 175 cm / 3 niveles
Hauteur 175 cm / 3 niveaux

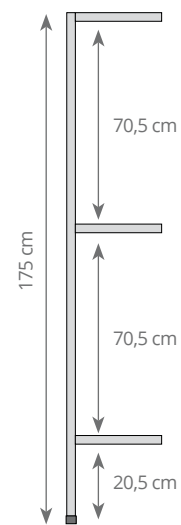

Height 175 cm / 4 levels
Altura 175 cm / 4 niveles
Hauteur 175 cm / 4 niveaux

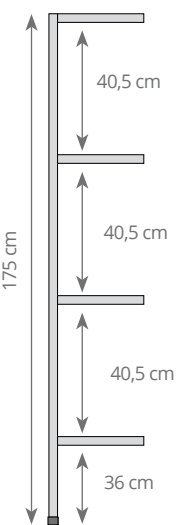

Height 130 cm / 3 levels
Altura 130 cm / 3 niveles
Hauteur 130 cm / 3 niveaux

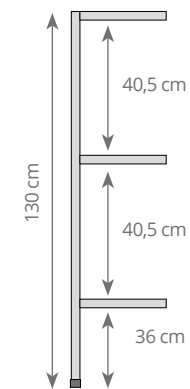

Height 175 cm / 5 levels
Altura 175 cm / 5 niveles
Hauteur 175 cm / 5 niveaux

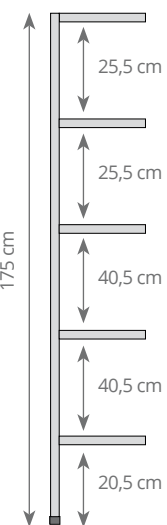

Height 205 cm / 4 levels
Altura 205 cm / 4 niveles
Hauteur 205 cm / 4 niveaux

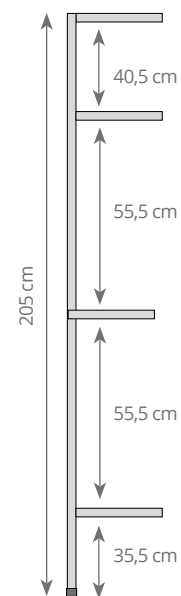

Height 205 cm / 5 levels
Altura 205 cm / 5 niveles
Hauteur 205 cm / 5 niveaux

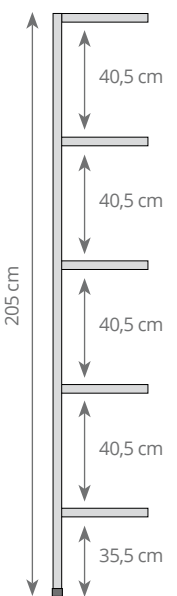

Height 205 cm / 6 levels
Altura 205 cm / 6 niveles
Hauteur 205 cm / 6 niveaux

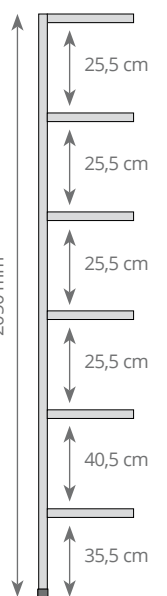

Combinations

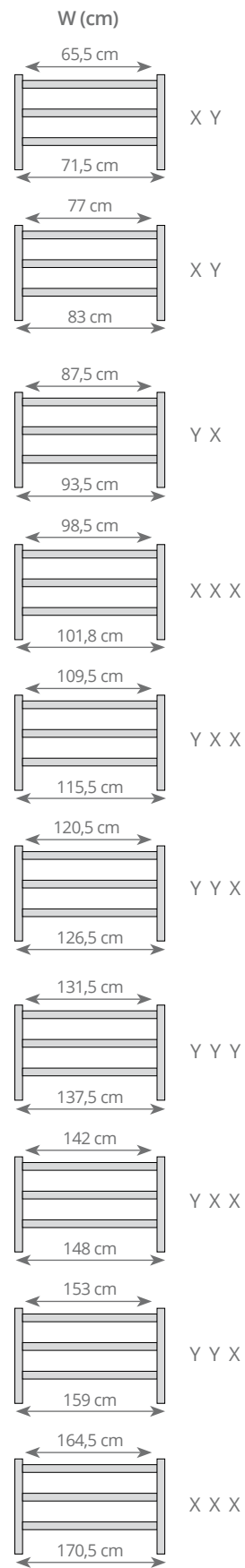

Complete and angular shelving

Estanterías completas y angulares
Rayonnages complets et angulaires



11.1 Full shelf

Estantería completa
Rayonnage complet

3 Levels
Niveles
Niveaux

Complete kits
Kits completos
Kits complets

Diferent combinations
Distintas combinaciones
Differentes combinaisons

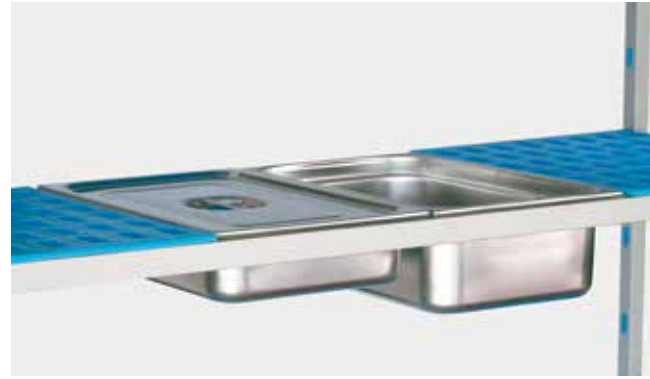

Compatible with 2/3 containers
Compatible con cubetas 2/3
Compatible avec bacs 2/3

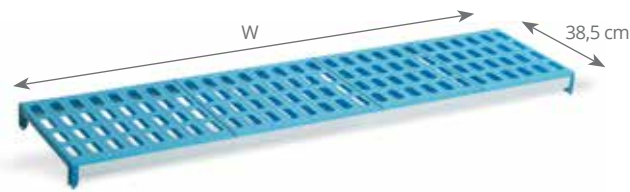

Compatible with 1/1 containers
Compatible con cubetas 1/1
Compatible avec bacs 1/1

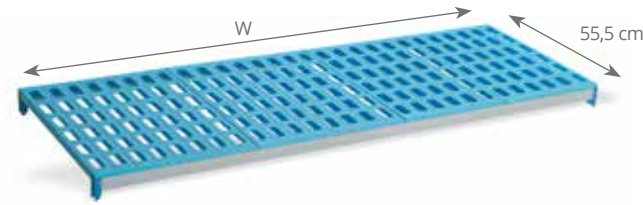

| REF | W cm | €/u |
|-------|-------|--------|
| P7000 | 71,5 | 295,00 |
| P7001 | 83,0 | 309,45 |
| P7002 | 93,5 | 321,10 |
| P7003 | 104,5 | 334,15 |
| P7004 | 115,5 | 350,75 |
| P7005 | 126,5 | 366,95 |
| P7006 | 137,5 | 385,25 |
| P7007 | 148,0 | 400,45 |
| P7008 | 159,0 | 417,30 |
| P7009 | 170,5 | 434,15 |
| P7010 | 184,0 | 560,70 |
| P7011 | 195,0 | 573,80 |
| P7012 | 206,0 | 586,75 |
| P7013 | 217,0 | 603,60 |
| P7014 | 228,0 | 620,35 |
| P7015 | 238,8 | 636,50 |
| P7016 | 249,6 | 652,70 |
| P7017 | 260,8 | 671,05 |
| P7018 | 272,0 | 689,55 |
| P7019 | 282,5 | 704,70 |
| P7020 | 293,0 | 719,70 |
| P7021 | 304,0 | 736,45 |
| P7022 | 315,0 | 753,15 |
| P7023 | 326,5 | 769,95 |

| REF | W cm | €/u |
|-------|-------|----------|
| P7024 | 338,0 | 786,60 |
| P7025 | 351,3 | 905,95 |
| P7026 | 362,1 | 922,20 |
| P7027 | 372,9 | 938,50 |
| P7028 | 384,1 | 956,85 |
| P7029 | 395,3 | 975,25 |
| P7030 | 406,5 | 993,65 |
| P7031 | 417,0 | 1.008,60 |
| P7032 | 427,5 | 1.023,80 |
| P7033 | 438,0 | 1.039,00 |
| P7034 | 449,0 | 1.055,60 |
| P7035 | 460,0 | 1.072,25 |
| P7036 | 471,0 | 1.089,05 |
| P7037 | 482,5 | 1.105,85 |
| P7038 | 494,0 | 1.122,40 |
| P7039 | 505,5 | 1.139,15 |
| P7040 | 518,6 | 1.261,05 |
| P7041 | 529,8 | 1.279,25 |
| P7042 | 541,0 | 1.297,75 |
| P7043 | 551,5 | 1.312,75 |
| P7044 | 562,0 | 1.327,90 |
| P7045 | 572,5 | 1.343,00 |
| P7046 | 583,0 | 1.357,95 |

| REF | W cm | €/u |
|-------|-------|--------|
| P7141 | 71,5 | 327,90 |
| P7142 | 83,0 | 341,50 |
| P7143 | 93,5 | 356,70 |
| P7144 | 104,5 | 374,30 |
| P7145 | 115,5 | 396,65 |
| P7146 | 126,3 | 418,10 |
| P7147 | 137,5 | 431,05 |
| P7148 | 148,0 | 451,45 |
| P7149 | 159,0 | 466,65 |
| P7150 | 170,5 | 488,20 |
| P7151 | 184,0 | 623,40 |
| P7152 | 195,0 | 641,20 |
| P7153 | 206,0 | 658,80 |
| P7154 | 217,0 | 681,00 |
| P7155 | 228,0 | 703,50 |
| P7156 | 238,8 | 724,90 |
| P7157 | 249,6 | 746,15 |
| P7158 | 260,8 | 759,10 |
| P7159 | 272,0 | 772,25 |
| P7160 | 282,5 | 792,65 |
| P7161 | 293,0 | 813,15 |
| P7162 | 304,0 | 828,15 |
| P7163 | 315,0 | 843,30 |
| P7164 | 326,5 | 864,85 |

| REF | W cm | €/u |
|-------|-------|----------|
| P7165 | 338,0 | 886,60 |
| P7166 | 351,3 | 1.031,60 |
| P7167 | 362,1 | 1.053,05 |
| P7168 | 372,9 | 1.074,40 |
| P7169 | 384,1 | 1.087,40 |
| P7170 | 395,3 | 1.100,35 |
| P7171 | 406,5 | 1.113,45 |
| P7172 | 417,0 | 1.133,80 |
| P7173 | 427,5 | 1.154,25 |
| P7174 | 438,0 | 1.174,75 |
| P7175 | 449,0 | 1.189,90 |
| P7176 | 460,0 | 1.204,90 |
| P7177 | 471,0 | 1.219,85 |
| P7178 | 482,5 | 1.241,60 |
| P7179 | 494,0 | 1.263,05 |
| P7180 | 505,5 | 1.284,80 |
| P7181 | 518,6 | 1.428,55 |
| P7182 | 529,8 | 1.441,55 |
| P7183 | 541,0 | 1.454,60 |
| P7184 | 551,5 | 1.474,95 |
| P7185 | 562,0 | 1.495,45 |
| P7186 | 572,5 | 1.515,75 |
| P7187 | 583,0 | 1.536,25 |

IDEA! * For others heights, see the table (p. 278 - 281)
* Para otras alturas, consultar el desglose (p. 278 - 281)
* Pour autres hauteurs, consulter le tableau de décomposition (p. 278 - 281)

Shelving for angle 11.1

Estantería angular
Rayonnage angulaire

3 Levels
Niveles
Niveaux

Shelvings for angle
Estanterías angulares
Rayonnages angulaires

Diferent combinations
Distintas combinaciones
Differentes combinaisons



Included / Incluido / Compris :
Hooks to form angles
Ganchos para formar ángulos
Crochets pour faire les angles

Compatible with 2/3 containers
Compatible con cubetas 2/3
Compatible avec bacs 2/3

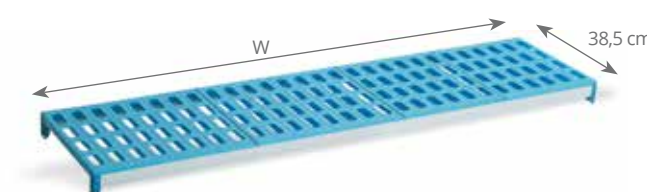

Compatible with 1/1 containers
Compatible con cubetas 1/1
Compatible avec bacs 1/1

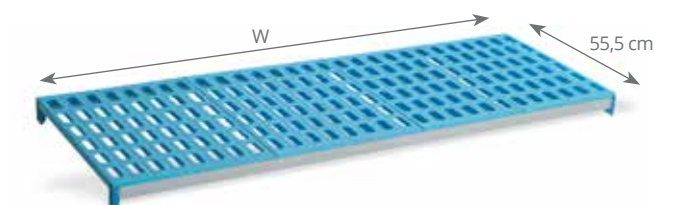

| REF | W cm | €/u |
|-------|-------|--------|
| P7282 | 68,5 | 246,30 |
| P7283 | 80,0 | 260,85 |
| P7284 | 90,5 | 272,30 |
| P7285 | 101,5 | 285,15 |
| P7286 | 112,5 | 302,15 |
| P7287 | 123,3 | 318,35 |
| P7288 | 134,5 | 336,75 |
| P7289 | 145,0 | 351,85 |
| P7290 | 156,0 | 368,60 |
| P7291 | 167,5 | 385,20 |
| P7292 | 181,0 | 512,00 |
| P7293 | 192,0 | 524,90 |
| P7294 | 203,0 | 538,00 |
| P7295 | 214,0 | 554,75 |
| P7296 | 225,0 | 571,55 |
| P7297 | 235,8 | 587,75 |
| P7298 | 246,6 | 603,95 |
| P7299 | 257,8 | 622,30 |
| P7300 | 269,0 | 640,75 |
| P7301 | 279,5 | 655,75 |
| P7302 | 290,0 | 670,90 |
| P7303 | 301,0 | 687,60 |
| P7304 | 312,0 | 704,45 |
| P7305 | 323,5 | 721,20 |

| REF | W cm | €/u |
|-------|-------|----------|
| P7306 | 335,0 | 737,80 |
| P7307 | 348,3 | 857,40 |
| P7308 | 359,1 | 873,60 |
| P7309 | 369,9 | 889,85 |
| P7310 | 381,1 | 908,15 |
| P7311 | 392,3 | 926,50 |
| P7312 | 403,5 | 944,70 |
| P7313 | 414,0 | 959,90 |
| P7314 | 424,5 | 975,00 |
| P7315 | 435,0 | 990,15 |
| P7316 | 446,0 | 1.006,85 |
| P7317 | 457,0 | 1.023,50 |
| P7318 | 468,0 | 1.040,25 |
| P7319 | 479,5 | 1.056,85 |
| P7320 | 491,0 | 1.073,85 |
| P7321 | 502,5 | 1.090,35 |
| P7322 | 515,6 | 1.212,10 |
| P7323 | 526,8 | 1.230,60 |
| P7324 | 538,0 | 1.248,80 |
| P7325 | 548,5 | 1.263,95 |
| P7326 | 559,0 | 1.279,00 |
| P7327 | 569,5 | 1.294,05 |
| P7328 | 580,0 | 1.309,25 |

| REF | W cm | €/u |
|-------|-------|--------|
| P7423 | 68,5 | 270,60 |
| P7424 | 80,0 | 284,25 |
| P7425 | 90,5 | 299,45 |
| P7426 | 101,5 | 317,05 |
| P7427 | 112,5 | 339,30 |
| P7428 | 123,3 | 360,70 |
| P7429 | 134,5 | 373,90 |
| P7430 | 145,0 | 394,15 |
| P7431 | 156,0 | 409,30 |
| P7432 | 167,5 | 430,85 |
| P7433 | 181,0 | 566,25 |
| P7434 | 192,0 | 583,95 |
| P7435 | 203,0 | 601,55 |
| P7436 | 214,0 | 624,00 |
| P7437 | 225,0 | 646,10 |
| P7438 | 235,8 | 667,55 |
| P7439 | 246,6 | 688,75 |
| P7440 | 257,8 | 701,80 |
| P7441 | 269,0 | 714,85 |
| P7442 | 279,5 | 735,30 |
| P7443 | 290,0 | 755,80 |
| P7444 | 301,0 | 770,85 |
| P7445 | 312,0 | 786,10 |
| P7446 | 323,5 | 807,55 |

| REF | W cm | €/u |
|-------|-------|----------|
| P7447 | 335,0 | 829,30 |
| P7448 | 348,3 | 974,30 |
| P7449 | 359,1 | 995,65 |
| P7450 | 369,9 | 1.017,05 |
| P7451 | 381,1 | 1.030,05 |
| P7452 | 392,3 | 1.043,10 |
| P7453 | 403,5 | 1.056,10 |
| P7454 | 414,0 | 1.076,35 |
| P7455 | 424,5 | 1.096,90 |
| P7456 | 435,0 | 1.117,50 |
| P7457 | 446,0 | 1.132,55 |
| P7458 | 457,0 | 1.147,50 |
| P7459 | 468,0 | 1.162,70 |
| P7460 | 479,5 | 1.184,35 |
| P7461 | 491,0 | 1.206,05 |
| P7462 | 502,5 | 1.227,40 |
| P7463 | 515,6 | 1.371,15 |
| P7464 | 526,8 | 1.384,10 |
| P7465 | 538,0 | 1.397,30 |
| P7466 | 548,5 | 1.417,60 |
| P7467 | 559,0 | 1.438,20 |
| P7468 | 569,5 | 1.458,50 |
| P7469 | 580,0 | 1.479,00 |

IDEA! * For others heights, see the table (p. 278 - 281)
* Para otras alturas, consultar el desglose (p. 278 - 281)
* Pour autres hauteurs, consulter le tableau de décomposition (p. 278 - 281)

11.1 Full shelf

Estantería completa
Rayonnage complet

4 Levels
Niveles
Niveaux

Complete kits
Kits completos
Kits complets

Diferent combinations
Distintas combinaciones
Differentes combinaisons

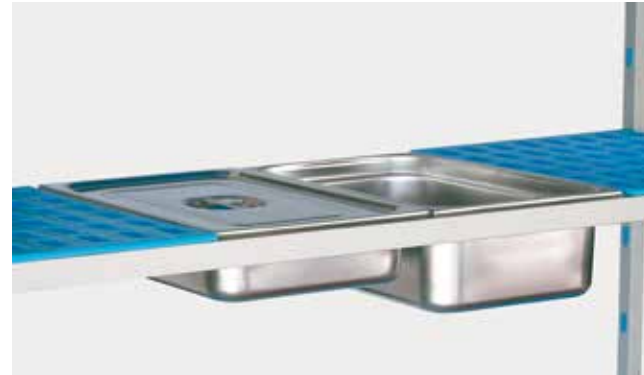

Compatible with 2/3 containers
Compatible con cubetas 2/3
Compatible avec bacs 2/3



Compatible with 1/1 containers
Compatible con cubetas 1/1
Compatible avec bacs 1/1

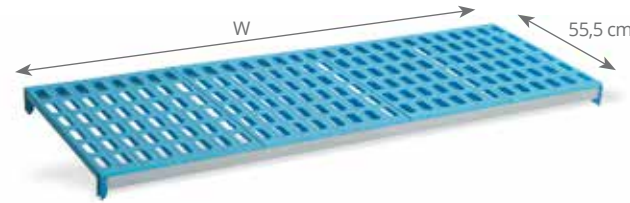
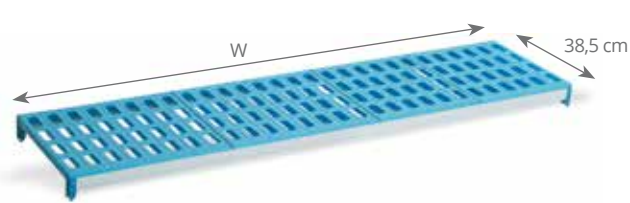

| REF | W cm | € / u | REF | W cm | € / u |
|-------|-------|--------|-------|-------|----------|
| P7047 | 71,5 | 346,95 | P7071 | 338,0 | 979,10 |
| P7048 | 83,0 | 366,25 | P7072 | 351,3 | 1.115,05 |
| P7049 | 93,5 | 381,65 | P7073 | 362,1 | 1.136,65 |
| P7050 | 104,5 | 398,95 | P7074 | 372,9 | 1.158,50 |
| P7051 | 115,5 | 421,25 | P7075 | 384,1 | 1.182,90 |
| P7052 | 126,3 | 442,95 | P7076 | 395,3 | 1.207,20 |
| P7053 | 137,5 | 467,40 | P7077 | 406,5 | 1.231,95 |
| P7054 | 148,0 | 487,65 | P7078 | 417,0 | 1.251,95 |
| P7055 | 159,0 | 509,80 | P7079 | 427,5 | 1.272,05 |
| P7056 | 170,5 | 532,15 | P7080 | 438,0 | 1.292,30 |
| P7057 | 184,0 | 592,85 | P7081 | 449,0 | 1.314,45 |
| P7058 | 195,0 | 695,30 | P7082 | 460,0 | 1.336,85 |
| P7059 | 206,0 | 712,70 | P7083 | 471,0 | 1.359,25 |
| P7060 | 217,0 | 734,95 | P7084 | 482,5 | 1.381,55 |
| P7061 | 228,0 | 771,30 | P7085 | 494,0 | 1.403,75 |
| P7062 | 238,8 | 779,00 | P7086 | 505,5 | 1.426,10 |
| P7063 | 249,6 | 800,70 | P7087 | 518,6 | 1.564,90 |
| P7064 | 260,8 | 825,10 | P7088 | 529,8 | 1.589,65 |
| P7065 | 272,0 | 849,60 | P7089 | 541,0 | 1.614,10 |
| P7066 | 282,5 | 869,70 | P7090 | 551,5 | 1.634,10 |
| P7067 | 293,0 | 889,95 | P7091 | 562,0 | 1.654,30 |
| P7068 | 304,0 | 912,25 | P7092 | 572,5 | 1.674,50 |
| P7069 | 315,0 | 934,55 | P7093 | 583,0 | 1.694,50 |
| P7070 | 326,5 | 956,70 | | | |

IDEA! * For others heights, see the table (p. 278 - 281)
* Para otras alturas, consultar el desglose (p. 278 - 281)
* Pour autres hauteurs, consulter le tableau de décomposition (p. 278 - 281)

Shelving for angle 11.1

Estantería angular
Rayonnage angulaire

4 Levels
Niveles
Niveaux

Shelvings for angle
Estanterías angulares
Rayonnages angulaires

Diferent combinations
Distintas combinaciones
Differentes combinaisons



Compatible with 2/3 containers
Compatible con cubetas 2/3
Compatible avec bacs 2/3

Included / Includo / Compris :
Hooks to form angles
Ganchos para formar ángulos
Crochets pour faire les angles



Compatible with 1/1 containers
Compatible con cubetas 1/1
Compatible avec bacs 1/1

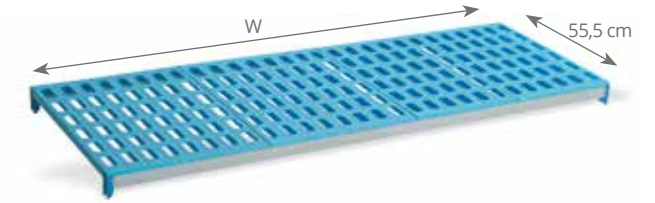
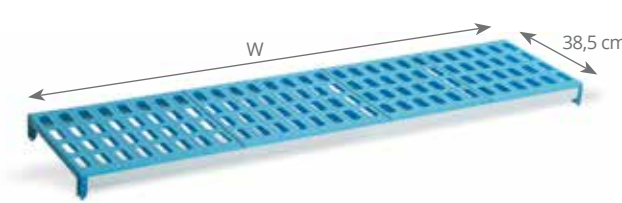

| REF | W cm | € / u | REF | W cm | € / u |
|-------|-------|--------|-------|-------|----------|
| P7329 | 68,5 | 294,25 | P7353 | 335,0 | 899,40 |
| P7330 | 80,0 | 313,50 | P7354 | 348,3 | 1.031,50 |
| P7331 | 90,5 | 329,00 | P7355 | 359,1 | 1.052,45 |
| P7332 | 101,5 | 346,30 | P7356 | 369,9 | 1.073,70 |
| P7333 | 112,5 | 368,70 | P7357 | 381,1 | 1.097,30 |
| P7334 | 123,3 | 390,25 | P7358 | 392,3 | 1.121,15 |
| P7335 | 134,5 | 414,80 | P7359 | 403,5 | 1.144,70 |
| P7336 | 145,0 | 434,90 | P7360 | 414,0 | 1.164,30 |
| P7337 | 156,0 | 457,20 | P7361 | 424,5 | 1.219,55 |
| P7338 | 167,5 | 479,55 | P7362 | 435,0 | 1.239,50 |
| P7339 | 181,0 | 625,40 | P7363 | 446,0 | 1.261,85 |
| P7340 | 192,0 | 642,65 | P7364 | 457,0 | 1.284,10 |
| P7341 | 203,0 | 660,15 | P7365 | 468,0 | 1.306,55 |
| P7342 | 214,0 | 682,35 | P7366 | 479,5 | 1.328,85 |
| P7343 | 225,0 | 704,70 | P7367 | 491,0 | 1.351,00 |
| P7344 | 235,8 | 726,50 | P7368 | 502,5 | 1.373,35 |
| P7345 | 246,6 | 747,95 | P7369 | 515,6 | 1.512,35 |
| P7346 | 257,8 | 772,55 | P7370 | 526,8 | 1.536,95 |
| P7347 | 269,0 | 797,05 | P7371 | 538,0 | 1.561,20 |
| P7348 | 279,5 | 817,05 | P7372 | 548,5 | 1.581,45 |
| P7349 | 290,0 | 837,20 | P7373 | 559,0 | 1.601,60 |
| P7350 | 301,0 | 859,45 | P7374 | 569,5 | 1.621,75 |
| P7351 | 312,0 | 881,90 | P7375 | 580,0 | 1.641,90 |
| P7352 | 323,5 | 892,05 | | | |

IDEA! * For others heights, see the table (p. 278 - 281)
* Para otras alturas, consultar el desglose (p. 278 - 281)
* Pour autres hauteurs, consulter le tableau de décomposition (p. 278 - 281)

11.1 Full shelf

Estantería completa
Rayonnage complet

5 Levels
Niveles
Niveaux

Complete kits
Kits completos
Kits complets

Diferent combinations
Distintas combinaciones
Diferentes combinaisons

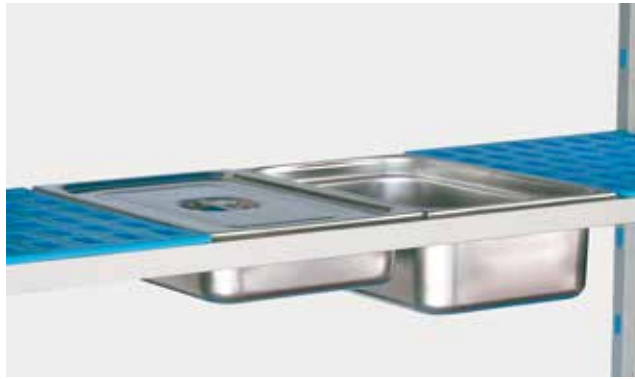

Compatible with 2/3 containers
Compatible con cubetas 2/3
Compatible avec bacs 2/3



Compatible with 1/1 containers
Compatible con cubetas 1/1
Compatible avec bacs 1/1

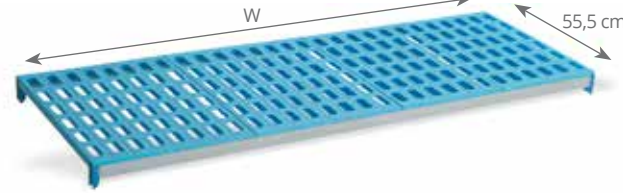
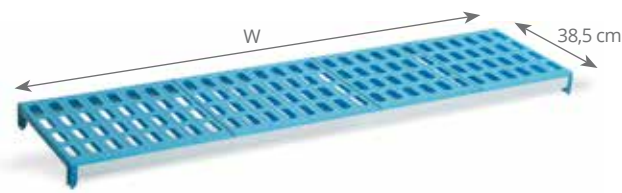

| REF | W cm | € / u | REF | W cm | € / u |
|-------|-------|----------|-------|-------|----------|
| P7094 | 71,5 | 397,95 | P7118 | 338,0 | 1.173,15 |
| P7095 | 83,0 | 423,95 | P7119 | 351,3 | 1.326,35 |
| P7096 | 93,5 | 443,35 | P7120 | 362,1 | 1.353,45 |
| P7097 | 104,5 | 464,95 | P7121 | 372,9 | 1.380,40 |
| P7098 | 115,5 | 492,90 | P7122 | 384,1 | 1.411,15 |
| P7099 | 126,3 | 519,95 | P7123 | 395,3 | 1.441,70 |
| P7100 | 137,5 | 550,45 | P7124 | 406,5 | 1.472,30 |
| P7101 | 148,0 | 575,60 | P7125 | 417,0 | 1.497,50 |
| P7102 | 159,0 | 603,60 | P7126 | 427,5 | 1.522,65 |
| P7103 | 170,5 | 631,45 | P7127 | 438,0 | 1.547,90 |
| P7104 | 184,0 | 796,85 | P7128 | 449,0 | 1.575,75 |
| P7105 | 195,0 | 818,60 | P7129 | 460,0 | 1.603,65 |
| P7106 | 206,0 | 840,20 | P7130 | 471,0 | 1.631,35 |
| P7107 | 217,0 | 868,25 | P7131 | 482,5 | 1.659,30 |
| P7108 | 228,0 | 895,95 | P7132 | 494,0 | 1.687,20 |
| P7109 | 238,8 | 923,15 | P7133 | 505,5 | 1.715,05 |
| P7110 | 249,6 | 950,25 | P7134 | 518,6 | 1.872,10 |
| P7111 | 260,8 | 980,85 | P7135 | 529,8 | 1.902,55 |
| P7112 | 272,0 | 1.011,40 | P7136 | 541,0 | 1.933,30 |
| P7113 | 282,5 | 1.036,50 | P7137 | 551,5 | 1.958,20 |
| P7114 | 293,0 | 1.061,65 | P7138 | 562,0 | 1.983,45 |
| P7115 | 304,0 | 1.089,65 | P7139 | 572,5 | 2.008,70 |
| P7116 | 315,0 | 1.117,60 | P7140 | 583,0 | 2.033,75 |
| P7117 | 326,5 | 1.145,35 | | | |

IDEA! * For others heights, see the table (p. 278 - 281)
* Para otras alturas, consultar el desglose (p. 278 - 281)
* Pour autres hauteurs, consulter le tableau de décomposition (p. 278 - 281)

Shelving for angle 11.1

Estantería angular
Rayonnage angulaire

5 Levels
Niveles
Niveaux

Shelvings for angle
Estanterías angulares
Rayonnages angulaires

Diferent combinations
Distintas combinaciones
Diferentes combinaisons



Compatible with 2/3 containers
Compatible con cubetas 2/3
Compatible avec bacs 2/3



Compatible with 1/1 containers
Compatible con cubetas 1/1
Compatible avec bacs 1/1

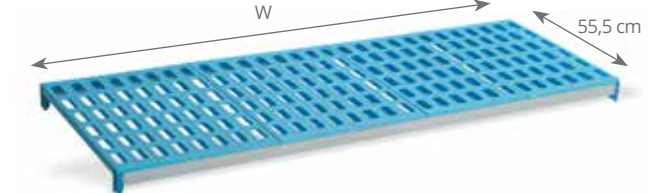
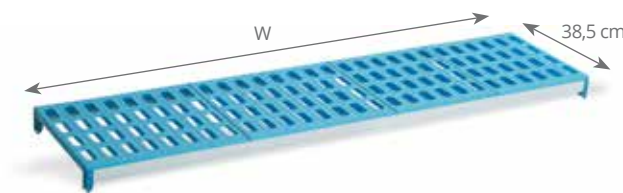

| REF | W cm | € / u | REF | W cm | € / u |
|-------|-------|----------|-------|-------|----------|
| P7376 | 68,5 | 342,85 | P7400 | 335,0 | 1.116,10 |
| P7377 | 80,0 | 366,85 | P7401 | 348,3 | 1.269,20 |
| P7378 | 90,5 | 386,35 | P7402 | 359,1 | 1.296,25 |
| P7379 | 101,5 | 407,85 | P7403 | 369,9 | 1.323,35 |
| P7380 | 112,5 | 435,70 | P7404 | 381,1 | 1.354,10 |
| P7381 | 123,3 | 462,90 | P7405 | 392,3 | 1.384,55 |
| P7382 | 134,5 | 493,45 | P7406 | 403,5 | 1.415,10 |
| P7383 | 145,0 | 518,65 | P7407 | 414,0 | 1.440,15 |
| P7384 | 156,0 | 546,50 | P7408 | 424,5 | 1.465,50 |
| P7385 | 167,5 | 574,35 | P7409 | 435,0 | 1.490,80 |
| P7386 | 181,0 | 739,95 | P7410 | 446,0 | 1.518,60 |
| P7387 | 192,0 | 761,60 | P7411 | 457,0 | 1.546,50 |
| P7388 | 203,0 | 783,15 | P7412 | 468,0 | 1.574,30 |
| P7389 | 214,0 | 811,25 | P7413 | 479,5 | 1.602,25 |
| P7390 | 225,0 | 838,90 | P7414 | 491,0 | 1.630,20 |
| P7391 | 235,8 | 866,05 | P7415 | 502,5 | 1.658,00 |
| P7392 | 246,6 | 893,30 | P7416 | 515,6 | 1.814,90 |
| P7393 | 257,8 | 923,80 | P7417 | 526,8 | 1.845,50 |
| P7394 | 269,0 | 954,30 | P7418 | 538,0 | 1.876,00 |
| P7395 | 279,5 | 979,50 | P7419 | 548,5 | 1.901,20 |
| P7396 | 290,0 | 1.004,70 | P7420 | 559,0 | 1.926,25 |
| P7397 | 301,0 | 1.032,55 | P7421 | 569,5 | 1.951,60 |
| P7398 | 312,0 | 1.060,35 | P7422 | 580,0 | 1.976,75 |
| P7399 | 323,5 | 1.088,25 | | | |

IDEA! * For others heights, see the table (p. 278 - 281)
* Para otras alturas, consultar el desglose (p. 278 - 281)
* Pour autres hauteurs, consulter le tableau de décomposition (p. 278 - 281)

11.2 Shelving with castors

Estanterías con ruedas
Rayonnages avec roues

Complete kits with wheels

Conjuntos completos con ruedas
Kits complets avec roues

 **Maximum weight per level 150 kg**
Maximum weight per shelving unit 400 kg

Peso máximo por nivel 150 kg
Peso máximo por estantería 400 kg
Poids maximum par niveau 150 kg
Poids maximum par rayonnage 400 kg



| REF | W x D x H cm | Type tipo | Levels Niveles Niveaux | €/u |  |
|--------|--------------------|-----------|------------------------|--------|---|
| P7145R | 114,5 x 55,5 x 188 | GN 1/1 | 3 | 645,90 | 1 |
| P7004R | 114,5 x 38,5 x 188 | GN 2/3 | 3 | 611,00 | 1 |
| P7146R | 126,5 x 55,5 x 188 | GN 1/1 | 3 | 667,45 | 1 |
| P7005R | 126,5 x 38,5 x 188 | GN 2/3 | 3 | 627,45 | 1 |
| P7147R | 137,5 x 55,5 x 188 | GN 1/1 | 3 | 680,45 | 1 |
| P7006R | 137,5 x 38,5 x 188 | GN 2/3 | 3 | 693,05 | 1 |

11.3 Bench

Bancadas
Bancs

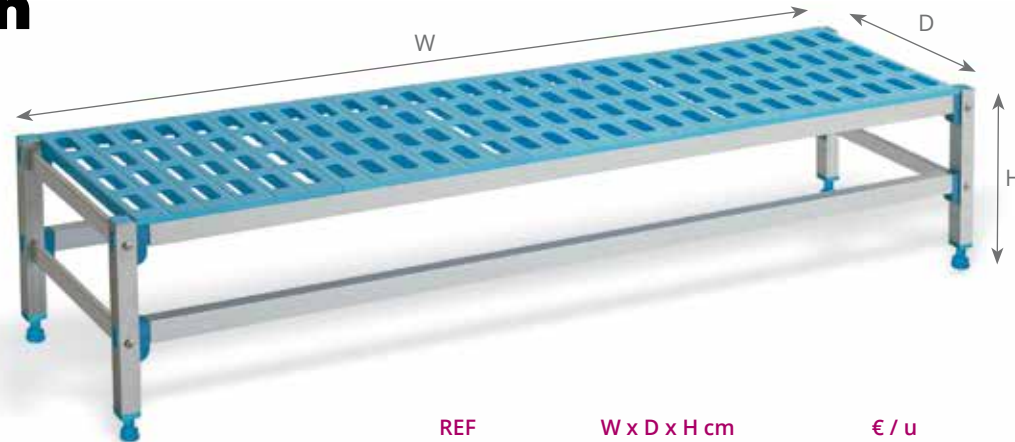

Designed to be used in places where it is forbidden to put boxes directly on the floor. Maximum load charge 175 Kg per bench, distributed weight throughout the bench. Leveling feet for gradient floors.

Diseñadas para su uso en lugares donde se prohíbe depositar cajas directamente en el suelo. Capacidad de carga de hasta 175 Kg por bancada, repartidos a lo largo de la bancada. Pie regulable para suelos desnivelados.

Conçus pour être utilisés quand il est interdit de poser les boîtes directement par terre. Charge maximale 175 Kg, distribués tout au long du banc. Pieds réglables pour sols irréguliers.

| REF | W x D x H cm | €/u |  |
|-------|-------------------|--------|---|
| P7603 | 71,5 x 55,5 x 28 | 147,95 | 1 |
| P7604 | 83,0 x 55,5 x 28 | 166,85 | 1 |
| P7605 | 93,5 x 55,5 x 28 | 174,50 | 1 |
| P7606 | 104,5 x 55,5 x 28 | 180,50 | 1 |
| P7607 | 115,5 x 55,5 x 28 | 184,90 | 1 |
| P7608 | 126,5 x 55,5 x 28 | 192,90 | 1 |
| P7609 | 137,5 x 55,5 x 28 | 201,50 | 1 |
| P7610 | 148,0 x 55,5 x 28 | 206,75 | 1 |
| P7611 | 71,5 x 38,5 x 28 | 145,25 | 1 |
| P7612 | 83,0 x 38,5 x 28 | 151,10 | 1 |
| P7613 | 93,5 x 38,5 x 28 | 157,85 | 1 |
| P7614 | 104,5 x 38,5 x 28 | 170,90 | 1 |
| P7615 | 115,5 x 38,5 x 28 | 173,65 | 1 |
| P7616 | 126,5 x 38,5 x 28 | 186,80 | 1 |
| P7617 | 137,5 x 38,5 x 28 | 189,80 | 1 |
| P7618 | 148,0 x 38,5 x 28 | 202,15 | 1 |

Parts 11.4

Componentes
Composants

Shelf support fixing

Soporte fijación estantería
Support fixation rayonnage



Two pieces kit
Conjunto de 2 soportes
Kit deux pièces

| REF | €/u |  |
|--------|-------|---|
| P76430 | 26,05 | 1 |



Crossbars

Travesaños
Longerons



| REF | W cm | €/u |  |
|-------|-------|-------|---|
| P7632 | 65,5 | 13,45 | 1 |
| P7633 | 77,0 | 14,90 | 1 |
| P7634 | 87,5 | 16,45 | 1 |
| P7635 | 98,5 | 17,40 | 1 |
| P7636 | 109,5 | 18,35 | 1 |
| P7637 | 120,5 | 21,05 | 1 |
| P7638 | 131,5 | 22,15 | 1 |
| P7639 | 142,0 | 22,95 | 1 |
| P7640 | 153,0 | 23,50 | 1 |
| P7641 | 164,5 | 26,00 | 1 |

Rack-shelves

Parrillas
Clayettes

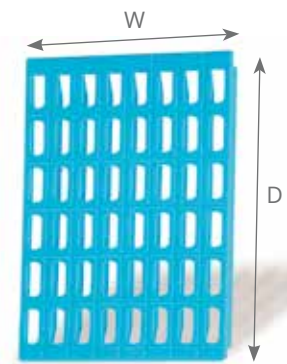

| REF | Type / Tipo | W x D cm | GN For / Para / Pour | €/u |  |
|-------|-------------|-------------|----------------------|-------|---|
| P7628 | Y | 55,5 x 43,5 | 1/1 | 13,25 | 1 |
| P7629 | X | 55,5 x 32,5 | 1/1 | 11,35 | 1 |
| P7630 | Y | 38,5 x 43,5 | 2/3 | 10,65 | 1 |
| P7631 | X | 38,5 x 32,5 | 2/3 | 9,70 | 1 |

Hooks to form angles

Ganchos para formar ángulos
Crochets pour faire les angles



| REF | €/u |  |
|-------|------|---|
| P7642 | 5,50 | 1 |

Support for crossbars

Pieza soporte para travesaños
Support pour longerons



| REF | €/u |  |
|-------|------|---|
| P7643 | 3,05 | 1 |

11.4 Parts

Componentes
Composants

Lateral supports

Soportes laterales
Suports latéraux



2 Available depths:
55,5 cm, 1/1 gastronorm
38,5 cm, 2/3 gastronorm

2 Fondos disponibles :
55,5 cm, gastronorm 1/1
38,5 cm, gastronorm 2/3

2 profondeurs disponibles:
55,5 cm, gastronorm 1/1
38,5 cm, gastronorm 2/3

Lateral support with wheels

Soportes laterales con ruedas
Suports latéraux avec roues

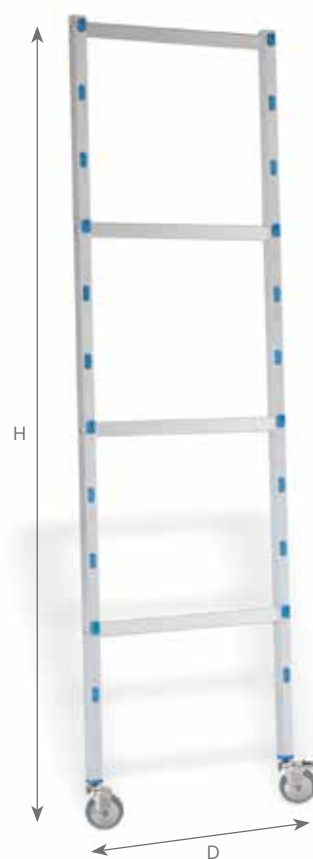

To assembly mobile shelving with wheels.
Para montar estanterías móviles con ruedas.
Pour monter rayonnages mobiles avec roues.

* Height including wheel
* Altura con rueda incluida
* Hauteur avec la roue incluse

Wheels Ø 12,5 cm, two of them with brake.
Ruedas de Ø 12,5 cm, dos de ellas con freno.
Roues de Ø 12,5 cm, dont deux avec frein.

We do not recommend crossbars longer than 140 cm.
No se recomiendan longitudes de travesaños superiores a 140 cm.
Nous ne conseillons pas des longerons plus longs de 140 cm.

| REF | MOD | D x H cm | Niveles Levels Niveaux | €/ u | 📦 |
|-------|-----|------------|------------------------------|--------|---|
| P7585 | S1 | 55,5 x 175 | 3 | 89,85 | 1 |
| P7586 | S2 | 55,5 x 175 | 4 | 92,95 | 1 |
| P7587 | S3 | 55,5 x 175 | 5 | 96,15 | 1 |
| P7646 | S0 | 55,5 x 200 | 4 | 102,85 | 1 |
| P7588 | S4 | 55,5 x 200 | 5 | 117,75 | 1 |
| P7589 | S5 | 55,5 x 200 | 6 | 120,90 | 1 |
| P7590 | S6 | 55,5 x 130 | 3 | 73,70 | 1 |
| P7591 | S7 | 38,5 x 175 | 3 | 81,40 | 1 |
| P7592 | S8 | 38,5 x 175 | 4 | 85,30 | 1 |
| P7593 | S9 | 38,5 x 175 | 5 | 89,60 | 1 |
| P7647 | S13 | 38,5 x 200 | 4 | 100,85 | 1 |
| P7594 | S10 | 38,5 x 200 | 5 | 114,60 | 1 |
| P7595 | S11 | 38,5 x 200 | 6 | 118,40 | 1 |
| P7596 | S12 | 38,5 x 130 | 3 | 69,85 | 1 |

| REF | D x H cm | Niveles Levels Niveaux | €/ u | 📦 |
|-------|------------|------------------------------|--------|---|
| P7597 | 55,5 x 188 | 3 | 214,55 | 1 |
| P7598 | 55,5 x 188 | 4 | 235,70 | 1 |
| P7599 | 55,5 x 188 | 5 | 242,25 | 1 |

Parts 11.4

Componentes
Composants

Shelves depth 38,5 cm

Estantes fondo 38,5 cm
Niveaux profondeur 38,5 cm

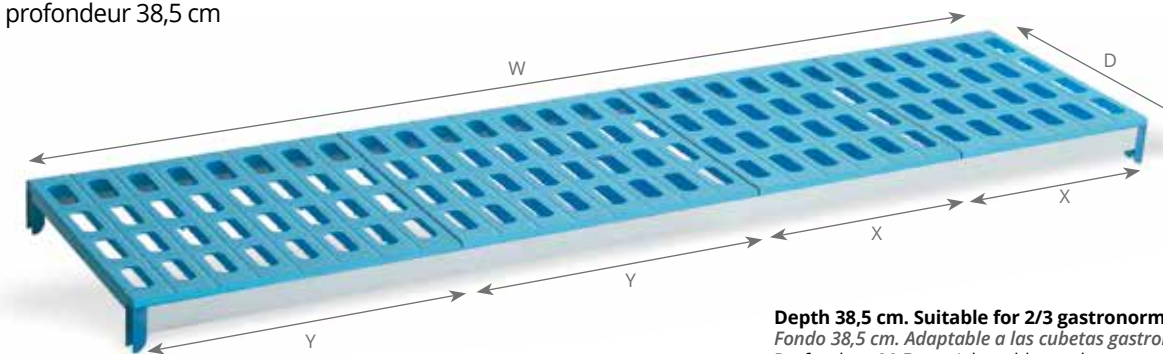

Depth 38,5 cm. Suitable for 2/3 gastronorm containers
Fondo 38,5 cm. Adaptable a las cubetas gastronorm 2/3
Profondeur 38,5 cm. Adaptable aux bacs gastronorm 2/3

X is a rack 32,5 cm width.
Y is a rack 43,5 cm width.

X significa una parrilla de ancho 32,5 cm.
Y significa una parrilla de ancho 43,5 cm.
X est une clayette de 32,5 cm de largeur.
Y est une clayette de 43,5 cm de largeur.

| REF | MOD | Combinación Combinaison | W x D cm | €/ u | 📦 |
|-------|------|----------------------------|--------------|-------|---|
| P7575 | T61 | X + X | 65,5 x 38,5 | 44,30 | 1 |
| P7576 | T71 | X + Y | 77,0 x 38,5 | 49,05 | 1 |
| P7577 | T81 | Y + Y | 87,5 x 38,5 | 52,90 | 1 |
| P7578 | T91 | X + X + X | 98,5 x 38,5 | 57,35 | 1 |
| P7579 | T101 | Y + X + X | 109,5 x 38,5 | 62,70 | 1 |
| P7580 | T111 | Y + Y + X | 120,5 x 38,5 | 68,10 | 1 |
| P7581 | T131 | Y + Y + Y | 131,5 x 38,5 | 74,25 | 1 |
| P7582 | T141 | Y + X + X + X | 142,0 x 38,5 | 79,40 | 1 |
| P7583 | T151 | Y + Y + X + X | 153,0 x 38,5 | 85,00 | 1 |
| P7584 | T161 | Y + Y + Y + X | 164,5 x 38,5 | 90,50 | 1 |

Shelves depth 55,5 cm

Estantes fondo 55,5 cm
Niveaux profondeur 55,5 cm

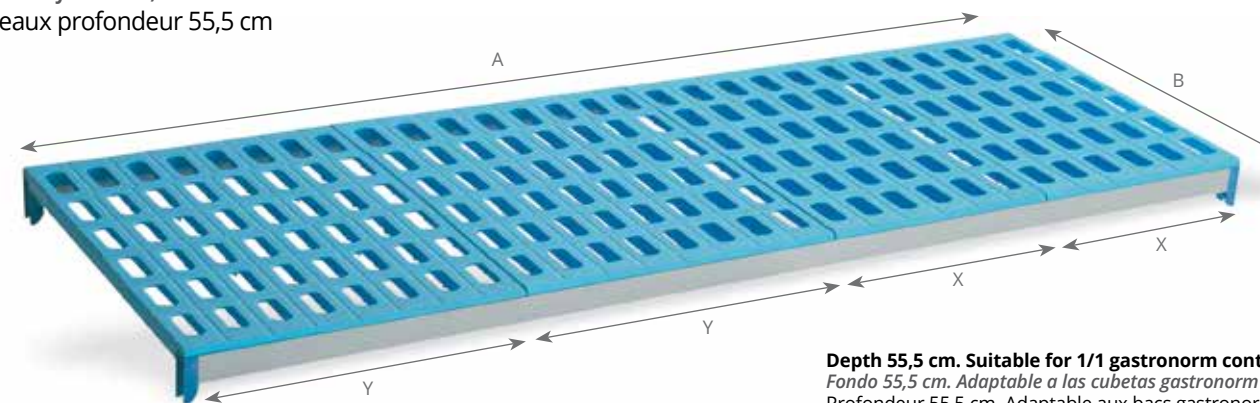

Depth 55,5 cm. Suitable for 1/1 gastronorm containers
Fondo 55,5 cm. Adaptable a las cubetas gastronorm 1/1
Profondeur 55,5 cm. Adaptable aux bacs gastronorm 1/1

X is a rack 32,5 cm width.
Y is a rack 43,5 cm width.

X significa una parrilla de ancho 32,5 cm.
Y significa una parrilla de ancho 43,5 cm.
X est une clayette de 32,5 cm de largeur.
Y est une clayette de 43,5 cm de largeur.

| REF | MOD | Combinación Combinaison | W x D cm | €/ u | 📦 |
|-------|-----|----------------------------|--------------|--------|---|
| P7565 | T6 | X + X | 65,5 x 55,5 | 49,45 | 1 |
| P7566 | T7 | X + Y | 77,0 x 55,5 | 54,05 | 1 |
| P7567 | T8 | Y + Y | 87,5 x 55,5 | 59,00 | 1 |
| P7568 | T9 | X + X + X | 98,5 x 55,5 | 65,00 | 1 |
| P7569 | T10 | Y + X + X | 109,5 x 55,5 | 72,35 | 1 |
| P7570 | T11 | Y + Y + X | 120,5 x 55,5 | 79,50 | 1 |
| P7571 | T13 | Y + Y + Y | 131,5 x 55,5 | 83,75 | 1 |
| P7572 | T14 | Y + X + X + X | 142,0 x 55,5 | 90,65 | 1 |
| P7573 | T15 | Y + Y + X + X | 153,0 x 55,5 | 95,70 | 1 |
| P7574 | T16 | Y + Y + Y + X | 164,5 x 55,5 | 102,85 | 1 |

11.5 Breakdown of shelving sets

Desglose conjuntos de estanterías
Décomposition kits rayonnages

DEPTH 38,5 cm. Suitable for 2/3 GASTRONORM

FONDO 38,5 cm. Adaptable a GASTRONORM 2/3

PROFONDEUR 38,5 cm. Adaptable aux GASTRONORME 2/3

| REF. 3 levels 3 niveles 3 niveaux | Breakdown Desglose Décomposition | REF. 4 levels 4 niveles 4 niveaux | Breakdown Desglose Décomposition | REF. 5 levels 5 niveles 5 niveaux | Breakdown Desglose Décomposition |
|--|--|--|--|--|--|
| P7000 | 2 S7 + 3 T61 | P7047 | 2 S8 + 4 T61 | P7094 | 2 S9 + 5 T61 |
| P7001 | 2 S7 + 3 T71 | P7048 | 2 S8 + 4 T71 | P7095 | 2 S9 + 5 T71 |
| P7002 | 2 S7 + 3 T81 | P7049 | 2 S8 + 4 T81 | P7096 | 2 S9 + 5 T81 |
| P7003 | 2 S7 + 3 T91 | P7050 | 2 S8 + 4 T91 | P7097 | 2 S9 + 5 T91 |
| P7004 | 2 S7 + 3 T101 | P7051 | 2 S8 + 4 T101 | P7098 | 2 S9 + 5 T101 |
| P7005 | 2 S7 + 3 T111 | P7052 | 2 S8 + 4 T111 | P7099 | 2 S9 + 5 T111 |
| P7006 | 2 S7 + 3 T131 | P7053 | 2 S8 + 4 T131 | P7100 | 2 S9 + 5 T131 |
| P7007 | 2 S7 + 3 T141 | P7054 | 2 S8 + 4 T141 | P7101 | 2 S9 + 5 T141 |
| P7008 | 2 S7 + 3 T151 | P7055 | 2 S8 + 4 T151 | P7102 | 2 S9 + 5 T151 |
| P7009 | 2 S7 + 3 T161 | P7056 | 2 S8 + 4 T161 | P7103 | 2 S9 + 5 T161 |
| P7010 | 3 S7 + 6 T81 | P7057 | 3 S8 + 8 T81 | P7104 | 3 S9 + 10 T81 |
| P7011 | 3 S7 + 3 T81 + 3 T91 | P7058 | 3 S8 + 4 T81 + 4 T91 | P7105 | 3 S9 + 5 T81 + 5 T91 |
| P7012 | 3 S7 + 6 T91 | P7059 | 3 S8 + 8 T91 | P7106 | 3 S9 + 10 T91 |
| P7013 | 3 S7 + 3 T91 + 3 T101 | P7060 | 3 S8 + 4 T91 + 4 T101 | P7107 | 3 S9 + 5 T91 + 5 T101 |
| P7014 | 3 S7 + 6 T101 | P7061 | 3 S8 + 8 T101 | P7108 | 3 S9 + 10 T101 |
| P7015 | 3 S7 + 3 T101 + 3 T111 | P7062 | 3 S8 + 4 T101 + 4 T111 | P7109 | 3 S9 + 5 T101 + 5 T111 |
| P7016 | 3 S7 + 6 T111 | P7063 | 3 S8 + 8 T111 | P7110 | 3 S9 + 10 T111 |
| P7017 | 3 S7 + 3 T111 + 3 T131 | P7064 | 3 S8 + 4 T111 + 4 T131 | P7111 | 3 S9 + 5 T111 + 5 T131 |
| P7018 | 3 S7 + 6 T131 | P7065 | 3 S8 + 8 T131 | P7112 | 3 S9 + 10 T131 |
| P7019 | 3 S7 + 3 T131 + 3 T141 | P7066 | 3 S8 + 4 T131 + 4 T141 | P7113 | 3 S9 + 5 T131 + 5 T141 |
| P7020 | 3 S7 + 6 T141 | P7067 | 3 S8 + 8 T141 | P7114 | 3 S9 + 10 T141 |
| P7021 | 3 S7 + 3 T141 + 3 T151 | P7068 | 3 S8 + 4 T141 + 4 T151 | P7115 | 3 S9 + 5 T141 + 5 T151 |
| P7022 | 3 S7 + 6 T151 | P7069 | 3 S8 + 8 T151 | P7116 | 3 S9 + 10 T151 |
| P7023 | 3 S7 + 3 T151 + 3 T161 | P7070 | 3 S8 + 4 T151 + 4 T161 | P7117 | 3 S9 + 5 T151 + 5 T161 |
| P7024 | 3 S7 + 6 T161 | P7071 | 3 S8 + 8 T161 | P7118 | 3 S9 + 10 T161 |
| P7025 | 4 S7 + 6 T101 + 3 T111 | P7072 | 4 S8 + 8 T101 + 4 T111 | P7119 | 4 S9 + 10 T101 + 5 T111 |
| P7026 | 4 S7 + 3 T101 + 6 T111 | P7073 | 4 S8 + 4 T101 + 8 T111 | P7120 | 4 S9 + 5 T101 + 10 T111 |
| P7027 | 4 S7 + 9 T111 | P7074 | 4 S8 + 12 T111 | P7121 | 4 S9 + 15 T111 |
| P7028 | 4 S7 + 6 T111 + 3 T131 | P7075 | 4 S8 + 8 T111 + 4 T131 | P7122 | 4 S9 + 10 T111 + 5 T131 |
| P7029 | 4 S7 + 3 T111 + 6 T131 | P7076 | 4 S8 + 4 T111 + 8 T131 | P7123 | 4 S9 + 5 T111 + 10 T131 |
| P7030 | 4 S7 + 9 T131 | P7077 | 4 S8 + 12 T131 | P7124 | 4 S9 + 15 T131 |
| P7031 | 4 S7 + 6 T131 + 3 T141 | P7078 | 4 S8 + 8 T131 + 4 T141 | P7125 | 4 S9 + 10 T131 + 5 T141 |
| P7032 | 4 S7 + 3 T131 + 6 T141 | P7079 | 4 S8 + 4 T131 + 8 T141 | P7126 | 4 S9 + 5 T131 + 10 T141 |
| P7033 | 4 S7 + 9 T141 | P7080 | 4 S8 + 12 T141 | P7127 | 4 S9 + 15 T141 |
| P7034 | 4 S7 + 6 T141 + 3 T151 | P7081 | 4 S8 + 8 T141 + 4 T151 | P7128 | 4 S9 + 10 T141 + 5 T151 |
| P7035 | 4 S7 + 3 T141 + 6 T151 | P7082 | 4 S8 + 4 T141 + 8 T151 | P7129 | 4 S9 + 5 T141 + 10 T151 |
| P7036 | 4 S7 + 9 T151 | P7083 | 4 S8 + 12 T151 | P7130 | 4 S9 + 15 T151 |
| P7037 | 4 S7 + 6 T151 + 3 T161 | P7084 | 4 S8 + 8 T151 + 4 T161 | P7131 | 4 S9 + 10 T151 + 5 T161 |
| P7038 | 4 S7 + 3 T151 + 6 T161 | P7085 | 4 S8 + 4 T151 + 8 T161 | P7132 | 4 S9 + 5 T151 + 10 T161 |
| P7039 | 4 S7 + 9 T161 | P7086 | 4 S8 + 12 T161 | P7133 | 4 S9 + 15 T161 |
| P7040 | 5 S7 + 6 T111 + 6 T131 | P7087 | 5 S8 + 8 T111 + 8 T131 | P7134 | 5 S9 + 10 T111 + 10 T131 |
| P7041 | 5 S7 + 3 T111 + 9 T131 | P7088 | 5 S8 + 4 T111 + 12 T131 | P7135 | 5 S9 + 5 T111 + 15 T131 |
| P7042 | 5 S7 + 12 T131 | P7089 | 5 S8 + 16 T131 | P7136 | 5 S9 + 20 T131 |
| P7043 | 5 S7 + 3 T141 + 9 T131 | P7090 | 5 S8 + 4 T141 + 12 T131 | P7137 | 5 S9 + 5 T141 + 15 T131 |
| P7044 | 5 S7 + 6 T131 + 6 T141 | P7091 | 5 S8 + 8 T131 + 8 T141 | P7138 | 5 S9 + 10 T131 + 10 T141 |
| P7045 | 5 S7 + 3 T131 + 9 T141 | P7092 | 5 S8 + 4 T131 + 12 T141 | P7139 | 5 S9 + 5 T131 + 15 T141 |
| P7046 | 5 S7 + 12 T141 | P7093 | 5 S8 + 16 T141 | P7140 | 5 S9 + 20 T141 |

Breakdown of shelving sets 11.5

Desglose conjuntos de estanterías
Décomposition kits rayonnages

DEPTH 55,5 cm. Suitable for 1/1 GASTRONORM

FONDO 55,5 cm. Adaptable a GASTRONORM 1/1

PROFONDEUR 55,5 cm. Adaptable aux GASTRONORME 1/1

| REF. 3 levels 3 niveles 3 niveaux | Breakdown Desglose Décomposition | REF. 4 levels 4 niveles 4 niveaux | Breakdown Desglose Décomposition | REF. 5 levels 5 niveles 5 niveaux | Breakdown Desglose Décomposition |
|--|--|--|--|--|--|
| P7141 | 2 S1 + 3 T6 | P7188 | 2 S2 + 4 T6 | P7235 | 2 S3 + 5 T6 |
| P7142 | 2 S1 + 3 T7 | P7189 | 2 S2 + 4 T7 | P7236 | 2 S3 + 5 T7 |
| P7143 | 2 S1 + 3 T8 | P7190 | 2 S2 + 4 T8 | P7237 | 2 S3 + 5 T8 |
| P7144 | 2 S1 + 3 T9 | P7191 | 2 S2 + 4 T9 | P7238 | 2 S3 + 5 T9 |
| P7145 | 2 S1 + 3 T10 | P7192 | 2 S2 + 4 T10 | P7239 | 2 S3 + 5 T10 |
| P7146 | 2 S1 + 3 T11 | P7193 | 2 S2 + 4 T11 | P7240 | 2 S3 + 5 T11 |
| P7147 | 2 S1 + 3 T13 | P7194 | 2 S2 + 4 T13 | P7241 | 2 S3 + 5 T13 |
| P7148 | 2 S1 + 3 T14 | P7195 | 2 S2 + 4 T14 | P7242 | 2 S3 + 5 T14 |
| P7149 | 2 S1 + 3 T15 | P7196 | 2 S2 + 4 T15 | P7243 | 2 S3 + 5 T15 |
| P7150 | 2 S1 + 3 T16 | P7197 | 2 S2 + 4 T16 | P7244 | 2 S3 + 5 T16 |
| P7151 | 3 S1 + 6 T8 | P7198 | 3 S2 + 8 T8 | P7245 | 3 S3 + 10 T8 |
| P7152 | 3 S1 + 3 T8 + 3 T9 | P7199 | 3 S2 + 4 T8 + 4 T9 | P7246 | 3 S3 + 5 T8 + 5 T9 |
| P7153 | 3 S1 + 6 T9 | P7200 | 3 S2 + 8 T9 | P7247 | 3 S3 + 10 T9 |
| P7154 | 3 S1 + 3 T9 + 3 T10 | P7201 | 3 S2 + 4 T9 + 4 T10 | P7248 | 3 S3 + 5 T9 + 5 T10 |
| P7155 | 3 S1 + 6 T10 | P7202 | 3 S2 + 8 T10 | P7249 | 3 S3 + 10 T10 |
| P7156 | 3 S1 + 3 T10 + 3 T11 | P7203 | 3 S2 + 4 T10 + 4 T11 | P7250 | 3 S3 + 5 T10 + 5 T11 |
| P7157 | 3 S1 + 6 T11 | P7204 | 3 S2 + 8 T11 | P7251 | 3 S3 + 10 T11 |
| P7158 | 3 S1 + 3 T11 + 3 T13 | P7205 | 3 S2 + 4 T11 + 4 T13 | P7252 | 3 S3 + 5 T11 + 5 T13 |
| P7159 | 3 S1 + 6 T13 | P7206 | 3 S2 + 8 T13 | P7253 | 3 S3 + 10 T13 |
| P7160 | 3 S1 + 3 T13 + 3 T14 | P7207 | 3 S2 + 4 T13 + 4 T14 | P7254 | 3 S3 + 5 T13 + 5 T14 |
| P7161 | 3 S1 + 6 T14 | P7208 | 3 S2 + 8 T14 | P7255 | 3 S3 + 10 T14 |
| P7162 | 3 S1 + 3 T14 + 3 T15 | P7209 | 3 S2 + 4 T14 + 4 T15 | P7256 | 3 S3 + 5 T14 + 5 T15 |
| P7163 | 3 S1 + 6 T15 | P7210 | 3 S2 + 8 T15 | P7257 | 3 S3 + 10 T15 |
| P7164 | 3 S1 + 3 T15 + 3 T16 | P7211 | 3 S2 + 4 T15 + 4 T16 | P7258 | 3 S3 + 5 T15 + 5 T16 |
| P7165 | 3 S1 + 6 T16 | P7212 | 3 S2 + 8 T16 | P7259 | 3 S3 + 10 T16 |
| P7166 | 4 S1 + 6 T10 + 3 T11 | P7213 | 4 S2 + 8 T10 + 4 T11 | P7260 | 4 S3 + 10 T10 + 5 T11 |
| P7167 | 4 S1 + 3 T10 + 6 T11 | P7214 | 4 S2 + 4 T10 + 8 T11 | P7261 | 4 S3 + 5 T10 + 10 T11 |
| P7168 | 4 S1 + 9 T11 | P7215 | 4 S2 + 12 T11 | P7262 | 4 S3 + 15 T11 |
| P7169 | 4 S1 + 6 T11 + 3 T13 | P7216 | 4 S2 + 8 T11 + 4 T13 | P7263 | 4 S3 + 10 T11 + 5 T13 |
| P7170 | 4 S1 + 3 T11 + 6 T13 | P7217 | 4 S2 + 4 T11 + 8 T13 | P7264 | 4 S3 + 5 T11 + 10 T13 |
| P7171 | 4 S1 + 9 T13 | P7218 | 4 S2 + 12 T13 | P7265 | 4 S3 + 15 T13 |
| P7172 | 4 S1 + 6 T13 + 3 T14 | P7219 | 4 S2 + 8 T13 + 4 T14 | P7266 | 4 S3 + 10 T13 + 5 T14 |
| P7173 | 4 S1 + 3 T13 + 6 T14 | P7220 | 4 S2 + 4 T13 + 8 T14 | P7267 | 4 S3 + 5 T13 + 10 T14 |
| P7174 | 4 S1 + 9 T14 | P7221 | 4 S2 + 12 T14 | P7268 | 4 S3 + 15 T14 |
| P7175 | 4 S1 + 6 T14 + 3 T15 | P7222 | 4 S2 + 8 T14 + 4 T15 | P7269 | 4 S3 + 10 T14 + 5 T15 |
| P7176 | 4 S1 + 3 T14 + 6 T15 | P7223 | 4 S2 + 4 T14 + 8 T15 | P7270 | 4 S3 + 5 T14 + 10 T15 |
| P7177 | 4 S1 + 9 T15 | P7224 | 4 S2 + 12 T15 | P7271 | 4 S3 + 15 T15 |
| P7178 | 4 S1 + 6 T15 + 3 T16 | P7225 | 4 S2 + 8 T15 + 4 T16 | P7272 | 4 S3 + 10 T15 + 5 T16 |
| P7179 | 4 S1 + 3 T15 + 6 T16 | P7226 | 4 S2 + 4 T15 + 8 T16 | P7273 | 4 S3 + 5 T15 + 10 T16 |
| P7180 | 4 S1 + 9 T16 | P7227 | 4 S2 + 12 T16 | P7274 | 4 S3 + 15 T16 |
| P7181 | 5 S1 + 6 T11 + 6 T13 | P7228 | 5 S2 + 8 T11 + 8 T13 | P7275 | 5 S3 + 10 T11 + 10 T13 |
| P7182 | 5 S1 + 3 T11 + 9 T13 | P7229 | 5 S2 + 4 T11 + 12 T13 | P7276 | 5 S3 + 5 T11 + 15 T13 |
| P7183 | 5 S1 + 12 T13 | P7230 | 5 S2 + 16 T13 | P7277 | 5 S3 + 20 T13 |
| P7184 | 5 S1 + 3 T14 + 9 T13 | P7231 | 5 S2 + 4 T14 + 12 T13 | P7278 | 5 S3 + 5 T14 + 15 T13 |
| P7185 | 5 S1 + 6 T13 + 6 T14 | P7232 | 5 S2 + 8 T13 + 8 T14 | P7279 | 5 S3 + 10 T13 + 10 T14 |
| P7186 | 5 S1 + 3 T13 + 9 T14 | P7233 | 5 S2 + 4 T13 + 12 T14 | P7280 | 5 S3 + 5 T13 + 15 T14 |
| P7187 | 5 S1 + 12 T14 | P7234 | 5 S2 + 16 T14 | P7281 | 5 S3 + 20 T14 |

11.5 Breakdown of shelving sets

Desglose conjuntos de estanterías
Décomposition kits rayonnages

DEPTH 38,5 cm. Suitable for 2/3 GASTRONORM

FONDO 38,5 cm. Adaptable a GASTRONORM 2/3

PROFONDEUR 38,5 cm. Adaptable aux GASTRONORME 2/3

| REF. 3 levels 3 niveles 3 niveaux | Breakdown Desglose Décomposition | REF. 4 levels 4 niveles 4 niveaux | Breakdown Desglose Décomposition | REF. 5 levels 5 niveles 5 niveaux | Breakdown Desglose Décomposition |
|--|--|--|--|--|--|
| P7282 | 1 S7 + 3 T61 | P7329 | 1 S8 + 4 T61 | P7376 | 1 S9 + 5 T61 |
| P7283 | 1 S7 + 3 T71 | P7330 | 1 S8 + 4 T71 | P7377 | 1 S9 + 5 T71 |
| P7284 | 1 S7 + 3 T81 | P7331 | 1 S8 + 4 T81 | P7378 | 1 S9 + 5 T81 |
| P7285 | 1 S7 + 3 T91 | P7332 | 1 S8 + 4 T91 | P7379 | 1 S9 + 5 T91 |
| P7286 | 1 S7 + 3 T101 | P7333 | 1 S8 + 4 T101 | P7380 | 1 S9 + 5 T101 |
| P7287 | 1 S7 + 3 T111 | P7334 | 1 S8 + 4 T111 | P7381 | 1 S9 + 5 T111 |
| P7288 | 1 S7 + 3 T131 | P7335 | 1 S8 + 4 T131 | P7382 | 1 S9 + 5 T131 |
| P7289 | 1 S7 + 3 T141 | P7336 | 1 S8 + 4 T141 | P7383 | 1 S9 + 5 T141 |
| P7290 | 1 S7 + 3 T151 | P7337 | 1 S8 + 4 T151 | P7384 | 1 S9 + 5 T151 |
| P7291 | 1 S7 + 3 T161 | P7338 | 1 S8 + 4 T161 | P7385 | 1 S9 + 5 T161 |
| P7292 | 2 S7 + 6 T81 | P7339 | 2 S8 + 8 T81 | P7386 | 2 S9 + 10 T81 |
| P7293 | 2 S7 + 3 T81 + 3 T91 | P7340 | 2 S8 + 4 T81 + 4 T91 | P7387 | 2 S9 + 5 T81 + 5 T91 |
| P7294 | 2 S7 + 6 T91 | P7341 | 2 S8 + 8 T91 | P7388 | 2 S9 + 10 T91 |
| P7295 | 2 S7 + 3 T91 + 3 T101 | P7342 | 2 S8 + 4 T91 + 4 T101 | P7389 | 2 S9 + 5 T91 + 5 T101 |
| P7296 | 2 S7 + 6 T101 | P7343 | 2 S8 + 8 T101 | P7390 | 2 S9 + 10 T101 |
| P7297 | 2 S7 + 3 T111 + 3 T111 | P7344 | 2 S8 + 4 T101 + 4 T111 | P7391 | 2 S9 + 5 T101 + 5 T111 |
| P7298 | 2 S7 + 6 T111 | P7345 | 2 S8 + 8 T111 | P7392 | 2 S9 + 10 T111 |
| P7299 | 2 S7 + 3 T111 + 3 T131 | P7346 | 2 S8 + 4 T111 + 4 T131 | P7393 | 2 S9 + 5 T111 + 5 T131 |
| P7300 | 2 S7 + 6 T131 | P7347 | 2 S8 + 8 T131 | P7394 | 2 S9 + 10 T131 |
| P7301 | 2 S7 + 3 T131 + 3 T141 | P7348 | 2 S8 + 4 T131 + 4 T141 | P7395 | 2 S9 + 5 T131 + 5 T141 |
| P7302 | 2 S7 + 6 T141 | P7349 | 2 S8 + 8 T141 | P7396 | 2 S9 + 10 T141 |
| P7303 | 2 S7 + 3 T141 + 3 T151 | P7350 | 2 S8 + 4 T141 + 4 T151 | P7397 | 2 S9 + 5 T141 + 5 T151 |
| P7304 | 2 S7 + 6 T151 | P7351 | 2 S8 + 8 T151 | P7398 | 2 S9 + 10 T151 |
| P7305 | 2 S7 + 3 T151 + 3 T161 | P7352 | 2 S8 + 4 T151 + 4 T161 | P7399 | 2 S9 + 5 T151 + 5 T161 |
| P7306 | 2 S7 + 6 T161 | P7353 | 2 S8 + 8 T161 | P7400 | 2 S9 + 10 T161 |
| P7307 | 3 S7 + 6 T101 + 3 T111 | P7354 | 3 S8 + 8 T101 + 4 T111 | P7401 | 3 S9 + 10 T101 + 5 T111 |
| P7308 | 3 S7 + 3 T101 + 6 T111 | P7355 | 3 S8 + 4 T101 + 8 T111 | P7402 | 3 S9 + 5 T101 + 10 T111 |
| P7309 | 3 S7 + 9 T111 | P7356 | 3 S8 + 12 T111 | P7403 | 3 S9 + 15 T111 |
| P7310 | 3 S7 + 6 T111 + 3 T131 | P7357 | 3 S8 + 8 T111 + 4 T131 | P7404 | 3 S9 + 10 T111 + 5 T131 |
| P7311 | 3 S7 + 3 T111 + 6 T131 | P7358 | 3 S8 + 4 T111 + 8 T131 | P7405 | 3 S9 + 5 T111 + 10 T131 |
| P7312 | 3 S7 + 9 T131 | P7359 | 3 S8 + 12 T131 | P7406 | 3 S9 + 15 T131 |
| P7313 | 3 S7 + 6 T131 + 3 T141 | P7360 | 3 S8 + 8 T131 + 4 T141 | P7407 | 3 S9 + 10 T131 + 5 T141 |
| P7314 | 3 S7 + 3 T131 + 6 T141 | P7361 | 3 S8 + 4 T131 + 8 T141 | P7408 | 3 S9 + 5 T131 + 10 T141 |
| P7315 | 3 S7 + 9 T141 | P7362 | 3 S8 + 12 T141 | P7409 | 3 S9 + 15 T141 |
| P7316 | 3 S7 + 6 T141 + 3 T151 | P7363 | 3 S8 + 8 T141 + 4 T151 | P7410 | 3 S9 + 10 T141 + 5 T151 |
| P7317 | 3 S7 + 3 T141 + 6 T151 | P7364 | 3 S8 + 4 T141 + 8 T151 | P7411 | 3 S9 + 5 T141 + 10 T151 |
| P7318 | 3 S7 + 9 T151 | P7365 | 3 S8 + 12 T151 | P7412 | 3 S9 + 15 T151 |
| P7319 | 3 S7 + 6 T151 + 3 T161 | P7366 | 3 S8 + 8 T151 + 4 T161 | P7413 | 3 S9 + 10 T151 + 5 T161 |
| P7320 | 3 S7 + 3 T151 + 6 T161 | P7367 | 3 S8 + 4 T151 + 8 T161 | P7414 | 3 S9 + 5 T151 + 10 T161 |
| P7321 | 3 S7 + 9 T161 | P7368 | 3 S8 + 12 T161 | P7415 | 3 S9 + 15 T161 |
| P7322 | 4 S7 + 6 T111 + 6 T131 | P7369 | 4 S8 + 8 T111 + 8 T131 | P7416 | 4 S9 + 10 T111 + 10 T131 |
| P7323 | 4 S7 + 3 T111 + 9 T131 | P7370 | 4 S8 + 4 T111 + 12 T131 | P7417 | 4 S9 + 5 T111 + 15 T131 |
| P7324 | 4 S7 + 12 T131 | P7371 | 4 S8 + 16 T131 | P7418 | 4 S9 + 20 T131 |
| P7325 | 4 S7 + 3 T141 + 9 T131 | P7372 | 4 S8 + 4 T141 + 12 T131 | P7419 | 4 S9 + 5 T141 + 15 T131 |
| P7326 | 4 S7 + 6 T131 + 6 T141 | P7373 | 4 S8 + 8 T131 + 8 T141 | P7420 | 4 S9 + 10 T131 + 10 T141 |
| P7327 | 4 S7 + 3 T131 + 9 T141 | P7374 | 4 S8 + 4 T131 + 12 T141 | P7421 | 4 S9 + 5 T131 + 15 T141 |
| P7328 | 4 S7 + 12 T141 | P7375 | 4 S8 + 16 T141 | P7422 | 4 S9 + 20 T141 |

Breakdown of shelving sets 11.5

Desglose conjuntos de estanterías
Décomposition kits rayonnages

DEPTH 55,5 cm. Suitable for 1/1 GASTRONORM

FONDO 55,5 cm. Adaptable a GASTRONORM 1/1

PROFONDEUR 55,5 cm. Adaptable aux GASTRONORME 1/1

| REF. 3 levels 3 niveles 3 niveaux | Breakdown Desglose Décomposition | REF. 4 levels 4 niveles 4 niveaux | Breakdown Desglose Décomposition | REF. 5 levels 5 niveles 5 niveaux | Breakdown Desglose Décomposition |
|--|--|--|--|--|--|
| P7423 | 1 S1 + 3 T6 | P7470 | 1 S2 + 4 T6 | P7517 | 1 S3 + 5 T6 |
| P7424 | 1 S1 + 3 T7 | P7471 | 1 S2 + 4 T7 | P7518 | 1 S3 + 5 T7 |
| P7425 | 1 S1 + 3 T8 | P7472 | 1 S2 + 4 T8 | P7519 | 1 S3 + 5 T8 |
| P7426 | 1 S1 + 3 T9 | P7473 | 1 S2 + 4 T9 | P7520 | 1 S3 + 5 T9 |
| P7427 | 1 S1 + 3 T10 | P7474 | 1 S2 + 4 T10 | P7521 | 1 S3 + 5 T10 |
| P7428 | 1 S1 + 3 T11 | P7475 | 1 S2 + 4 T11 | P7522 | 1 S3 + 5 T11 |
| P7429 | 1 S1 + 3 T13 | P7476 | 1 S2 + 4 T13 | P7523 | 1 S3 + 5 T13 |
| P7430 | 1 S1 + 3 T14 | P7477 | 1 S2 + 4 T14 | P7524 | 1 S3 + 5 T14 |
| P7431 | 1 S1 + 3 T15 | P7478 | 1 S2 + 4 T15 | P7525 | 1 S3 + 5 T15 |
| P7432 | 1 S1 + 3 T16 | P7479 | 1 S2 + 4 T16 | P7526 | 1 S3 + 5 T16 |
| P7433 | 2 S1 + 6 T8 | P7480 | 2 S2 + 8 T8 | P7527 | 2 S3 + 10 T8 |
| P7434 | 2 S1 + 3 T8 + 3 T9 | P7481 | 2 S2 + 4 T8 + 4 T9 | P7528 | 2 S3 + 5 T8 + 5 T9 |
| P7435 | 2 S1 + 6 T9 | P7482 | 2 S2 + 8 T9 | P7529 | 2 S3 + 10 T9 |
| P7436 | 2 S1 + 3 T9 + 3 T10 | P7483 | 2 S2 + 4 T9 + 4 T10 | P7530 | 2 S3 + 5 T9 + 5 T10 |
| P7437 | 2 S1 + 6 T10 | P7484 | 2 S2 + 8 T10 | P7531 | 2 S3 + 10 T10 |
| P7438 | 2 S1 + 3 T10 + 3 T11 | P7485 | 2 S2 + 4 T10 + 4 T11 | P7532 | 2 S3 + 5 T10 + 5 T11 |
| P7439 | 2 S1 + 6 T11 | P7486 | 2 S2 + 8 T11 | P7533 | 2 S3 + 10 T11 |
| P7440 | 2 S1 + 3 T11 + 3 T13 | P7487 | 2 S2 + 4 T11 + 4 T13 | P7534 | 2 S3 + 5 T11 + 5 T13 |
| P7441 | 2 S1 + 6 T13 | P7488 | 2 S2 + 8 T13 | P7535 | 2 S3 + 10 T13 |
| P7442 | 2 S1 + 3 T13 + 3 T14 | P7489 | 2 S2 + 4 T13 + 4 T14 | P7536 | 2 S3 + 5 T13 + 5 T14 |
| P7443 | 2 S1 + 6 T14 | P7490 | 2 S2 + 8 T14 | P7537 | 2 S3 + 10 T14 |
| P7444 | 2 S1 + 3 T14 + 3 T15 | P7491 | 2 S2 + 4 T14 + 4 T15 | P7538 | 2 S3 + 5 T14 + 5 T15 |
| P7445 | 2 S1 + 6 T15 | P7492 | 2 S2 + 8 T15 | P7539 | 2 S3 + 10 T15 |
| P7446 | 2 S1 + 3 T15 + 3 T16 | P7493 | 2 S2 + 4 T15 + 4 T16 | P7540 | 2 S3 + 5 T15 + 5 T16 |
| P7447 | 2 S1 + 6 T16 | P7494 | 2 S2 + 8 T16 | P7541 | 2 S3 + 10 T16 |
| P7448 | 3 S1 + 6 T10 + 3 T11 | P7495 | 3 S2 + 8 T10 + 4 T11 | P7542 | 3 S3 + 10 T10 + 5 T11 |
| P7449 | 3 S1 + 3 T10 + 6 T11 | P7496 | 3 S2 + 4 T10 + 8 T11 | P7543 | 3 S3 + 5 T10 + 10 T11 |
| P7450 | 3 S1 + 9 T11 | P7497 | 3 S2 + 12 T11 | P7544 | 3 S3 + 15 T11 |
| P7451 | 3 S1 + 6 T11 + 3 T13 | P7498 | 3 S2 + 8 T11 + 4 T13 | P7545 | 3 S3 + 10 T11 + 5 T13 |
| P7452 | 3 S1 + 3 T11 + 6 T13 | P7499 | 3 S2 + 4 T11 + 8 T13 | P7546 | 3 S3 + 5 T11 + 10 T13 |
| P7453 | 3 S1 + 9 T13 | P7500 | 3 S2 + 12 T13 | P7547 | 3 S3 + 15 T13 |
| P7454 | 3 S1 + 6 T13 + 3 T14 | P7501 | 3 S2 + 8 T13 + 4 T14 | P7548 | 3 S3 + 10 T13 + 5 T14 |
| P7455 | 3 S1 + 3 T13 + 6 T14 | P7502 | 3 S2 + 4 T13 + 8 T14 | P7549 | 3 S3 + 5 T13 + 10 T14 |
| P7456 | 3 S1 + 9 T14 | P7503 | 3 S2 + 12 T14 | P7550 | 3 S3 + 15 T14 |
| P7457 | 3 S1 + 6 T14 + 3 T15 | P7504 | 3 S2 + 8 T14 + 4 T15 | P7551 | 3 S3 + 10 T14 + 5 T15 |
| P7458 | 3 S1 + 3 T14 + 6 T15 | P7505 | 3 S2 + 4 T14 + 8 T15 | P7552 | 3 S3 + 5 T14 + 10 T15 |
| P7459 | 3 S1 + 9 T15 | P7506 | 3 S2 + 12 T15 | P7553 | 3 S3 + 15 T15 |
| P7460 | 3 S1 + 6 T15 + 3 T16 | P7507 | 3 S2 + 8 T15 + 4 T16 | P7554 | 3 S3 + 10 T15 + 5 T16 |
| P7461 | 3 S1 + 3 T15 + 6 T16 | P7508 | 3 S2 + 4 T15 + 8 T16 | P7555 | 3 S3 + 5 T15 + 10 T16 |
| P7462 | 3 S1 + 9 T16 | P7509 | 3 S2 + 12 T16 | P7556 | 3 S3 + 15 T16 |
| P7463 | 4 S1 + 6 T11 + 6 T13 | P7510 | 4 S2 + 8 T11 + 8 T13 | P7557 | 4 S3 + 10 T11 + 10 T13 |
| P7464 | 4 S1 + 3 T11 + 9 T13 | P7511 | 4 S2 + 4 T11 + 12 T13 | P7558 | 4 S3 + 5 T11 + 15 T13 |
| P7465 | 4 S1 + 12 T13 | P7512 | 4 S2 + 16 T13 | P7559 | 4 S3 + 20 T13 |
| P7466 | 4 S1 + 3 T14 + 9 T13 | P7513 | 4 S2 + 4 T14 + 12 T13 | P7560 | 4 S3 + 5 T14 + 15 T13 |
| P7467 | 4 S1 + 6 T13 + 6 T14 | P7514 | 4 S2 + 8 T13 + 8 T14 | P7561 | 4 S3 + 10 T13 + 10 T14 |
| P7468 | 4 S1 + 3 T13 + 9 T14 | P7515 | 4 S2 + 4 T13 + 12 T14 | P7562 | 4 S3 + 5 T13 + 15 T14 |
| P7469 | 4 S1 + 12 T14 | P7516 | 4 S2 + 16 T14 | P7563 | 4 S3 + 20 T14 |

12 Equipment

Maquinaria
Equipement



12.1 COOKING 288

COCCIÓN / COUSSION

Induction units / Placas inducción / Plaque induction 288

Warming induction units / Placas inducción mantenedoras 292
Plaque induction de maintien température

Ovens & micro-waves / Hornos y micro-ondas / Fours et micro-ondes 294

Fryers / Freidoras / Friteuses 295

12.2 TOASTERS & CONTACT GRILLS 296

TOSTADORAS Y GRILL DE CONTACTO

TOASTEURS ET GRILL DE CONTACT

Toasters / Tostadoras / Toasteurs 296

Contact grill / Grill de contacto / Grill de contact 301

12.3 FOOD PROCESSORS 302

PROCESADORES DE ALIMENTOS / ROBOTS MULTIFONCTION

Mixers / Batidoras planetarias / Mélangeurs 302

Slicing machines / Corta fiambres / Trancheurs 303

12.4 FOOD WARMING EQUIPMENT 304

MAQUINARIA MANTENEDORA DE TEMPERATURA

APPAREILS DE MAINTEN DE TEMPEÉRATURE

Rethermalizers / Retermalizadores / Appareil de remise en température 304

Bain marie / Baños maría / Bain-marie 310

Heating lamps / Lámparas mantenedoras / Lampe chauffante 315

Warming equipment / Mantenedores de temperatura 318
Maintenance de température

Hot banquet trolleys / Armarios calientes / Armoires chaudes 319

12.5 ICE-CREAM MACHINES 322

MAQUINARIA HELADERÍA / TURBINES À GLACE

Induction hobs

Placas inducción
Plaques induction

The new way of cooking: more efficient, faster, safer and more precise.

La nueva forma de cocinar: más eficiente, más rápida, más segura y más precisa.

La nouvelle manière de cuisiner : plus efficace, plus rapide, plus sûre et plus précise.

Energy efficient

Eficiencia energética
Efficacité énergétique

The electromagnetic field produced by induction hobs transmits the heat directly to the pan, avoiding the dispersal of energy that happens when cooking with gas.

El campo electromagnético producido por las placas de inducción transmite el calor directamente a la pieza evitando la dispersión de energía que se genera cocinando con gas.

Le champ électromagnétique produit par les plaques à induction transmet la chaleur directement à la pièce en évitant la déperdition d'énergie générée quand on cuisine au gaz.

Speed / Rapidez / Rapidité

As heat is directly transmitted to the pan, it will be concentrated where it is needed, saving both energy and time.

Siendo transmitido directamente a la olla, el calor, se concentra donde se necesita ahorrando energía y, obviamente, tiempo.

La chaleur étant transmise directement à la casserole, elle se concentre là où elle est nécessaire en économisant de l'énergie et, bien sûr, du temps.

Precision / Precisión / Précision

Thanks to their sensitivity, induction hobs give the chef an unbeatable ability to control the heat when compared to traditional hobs.

Gracias a su sensibilidad, las placas de inducción conceden al cocinero una capacidad de control incomparable con las cocinas tradicionales.

Grâce à leur sensibilité, les plaques à induction offrent au cuisinier une capacité de contrôle sans comparaison avec les cuisinières traditionnelles.

Safety / Seguridad / Sécurité

Without anything on the hob to activate the magnetic field, the induction hobs do not heat up.

Sin una pieza específica que active el campo magnético, las placas de inducción no se calientan.

À défaut d'une pièce adaptée capable d'activer le champ magnétique, les plaques ne chauffent pas.

Induction hobs

Placas inducción
Plaques induction



Induction hob
Cocina de inducción
Cuisinière à induction

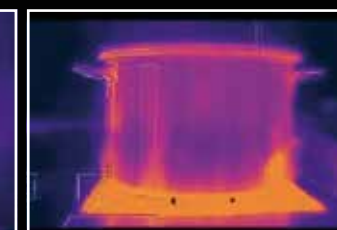

Gas hob
Cocina de gas
Cuisinière à gaz



Which induction unit do you need?

¿Qué placa de inducción necesita?
Quel plaque induction vous faut-il ?



Cooking
Cocinado
Cuisson

Temperature maintenance
Mantenimiento temperatura
Maintien en température

BRAND
MARCA
MARQUE

VOLLRATH

pujadas
A VOLLRATH COMPANY

VOLLRATH

| | VOLLRATH | | | | | | pujadas | | | | | VOLLRATH | | |
|--|--|--|--|--|--|---|--|--|--|--|---|--|--|--|
| | | | | | | | | | | | | | | |
| MODEL MODELO MODÈLE | HPI4 | 59650 | 59601 | 6954702 | 69523 | 6958302 | P15078 | P15072 | P15079 | P15077 | P688065 | 595027502 | 595087502 | 59641 |
| POWER POTENCIA PUISSANCE (W) | 3.800 W | 1.800 W | 1.800 W | 3.800 W | 5.800 W | 3.000 W | 3.500 W | 3.500 W | 3.500 W | 2.000 W | 3.100 W | 300 W | 375 W | 650 W |
| MAX. DIAM. DIÁMETRO MÁX. DIAMÈTRE MAX. | 35,6 cm | 26 cm | 30,5 cm | 30 x 2 cm | 30 x 2 cm | 35 cm | 26 cm | 26 cm | 26 cm | 26 cm | 40 cm | 40 cm | 60 cm | 36 cm |
| HEAT DISSIP. DISIP. CALOR DISSIP. CHALEUR | | | | | | | | | | | | | | |
| TYPE TIPO TYPE | Counter-top Sobremesa À poser sur table | Counter-top Sobremesa À poser sur table | Be built-in Encastrable Encastrable | Counter-top Sobremesa À poser sur table | Counter-top Sobremesa À poser sur table | Counter-top Sobremesa À poser sur table | Counter-top Sobremesa À poser sur table | Counter-top Sobremesa À poser sur table | Counter-top Sobremesa À poser sur table | Counter-top Sobremesa À poser sur table | Counter-top Sobremesa À poser sur table | Counter-top Sobremesa À poser sur table | Counter-top Sobremesa À poser sur table | Be built-in Encastrable Encastrable |
| SUITABLE APTO CONVIENT | Pots / Pans Ollas / Sartenes Casseroles / Poêles | Pots / Pans Ollas / Sartenes Casseroles / Poêles | Pots / Pans Ollas / Sartenes Casseroles / Poêles | Pots / Pans Ollas / Sartenes Casseroles / Poêles | Pots / Pans Ollas / Sartenes Casseroles / Poêles | Wok | Pots / Pans Ollas / Sartenes Casseroles / Poêles | Pots / Pans Ollas / Sartenes Casseroles / Poêles | Pots / Pans Ollas / Sartenes Casseroles / Poêles | Pots / Pans Ollas / Sartenes Casseroles / Poêles | Wok | Pots / Chaffing dishes Ollas / Chaffing Casseroles / Chauffe-plats | Pots / Chaffing dishes Ollas / Chaffing Casseroles / Chauffe-plats | Pots / Chaffing dishes Ollas / Chaffing Casseroles / Chauffe-plats |
| USE USO USAGE | Intensive Intensivo Intensif | Semi-intensive Semi-intensivo Semi-intensif | Semi-intensive Semi-intensivo Semi-intensif | Intensive Intensivo Intensif | Intensive Intensivo Intensif | Semi-intensive Semi-intensivo Semi-intensif | Semi-intensive Semi-intensivo Semi-intensif | Semi-intensive Semi-intensivo Semi-intensif | Semi-intensive Semi-intensivo Semi-intensif | Moderate Moderado Modéré | Semi-intensive Semi-intensivo Semi-intensif | Intensive Intensivo Intensif | Intensive Intensivo Intensif | Intensive Intensivo Intensif |

EQUIPMENT
MAQUINARIA
EQUIPEMENT

EQUIPMENT
MAQUINARIA
EQUIPEMENT

12.1 Induction units

Placas de inducción
Plaque induction

4-Series

IT'S LIKE COOKING WITH GAS, ONLY BETTER!

Es como cocinar con gas, ¡solo que mejor!
Comme la cuisine au gaz, mais en mieux!

- 93 % Efficiency**
Eficiencia
Efficacité
- 100 Power levels**
Niveles de potencia
Niveaux de puissance
- 27-232 °C Temperature levels**
Niveles de temperatura
Niveaux de température
- 24 h Timer with audible alarm**
Temporizador con alarma sonora
Minuterie avec alarme sonore
- Heavy-duty usage**
Uso intensivo
Intensif usage

Expanded magnetic field emulates gas to allow uninterrupted heat while lifting or tilting pan.

New smarter, faster pan detection technology delivers immediate heat when placing a pan on the surface.

Four customizable programs deliver repeatable results with the touch of a button.

El campo magnético expandido emula el gas para proporcionar un calor ininterrumpido mientras se levanta la sartén.

La nueva tecnología de detección más inteligente y rápida proporciona calor inmediato cuando se coloca la sartén sobre la superficie.

Cuatro programas personalizables ofrecen resultados repetibles con solo pulsar un botón.

Champ magnétique étendu qui imite la cuisson au gaz pour permettre une chaleur ininterrompue si la poêle est soulevée ou inclinée.

Nouvelle technologie de détection, plus intelligente et plus rapide qui apporte une chaleur immédiate lorsque la poêle est placée sur la surface.

Quatre programmes personnalisables avec des résultats répétables en appuyant sur un seul bouton.

Ceramic glass cooking surface
Superficie de cocción de cristal vitrocerámica
Surface de cuisson vitrocéramique

Improved control knob with power and temperature level adjustment
Nuevo y mejorado mando de control de temperatura y potencia
Nouveau bouton de contrôle de la température et la puissance amélioré

Touch screen control panel
Panel de control con pantalla táctil
Panneau de commande à écran tactile

Redesigned sleek heavy-duty stainless steel case with improved ventilation
Nueva caja de acero inoxidable para uso intensivo con ventilación mejorada
Nouveau boîtier en acier inoxydable pour usage intensif avec ventilation améliorée.

Temperature control probe
Sonda de control de temperatura
Sonde de contrôle de température



NEW!

HPI4 High power induction

Placa de inducción control temperatura
Plaque à induction contrôle température



| REF | CA/AC Volt. | W | A | Plug Ench. | Hz | € / u | ☐ |
|-------------|-------------|-------|------|------------|-------|----------|---|
| HPI4-260002 | 230 | 2.600 | 11.3 | EU | 50/60 | 2.441,10 | 1 |
| HPI4-260003 | 230 | 2.600 | 11.3 | UK | 50/60 | 2.441,10 | 1 |
| HPI4-260004 | 230 | 2.600 | 11.3 | CH | 50/60 | 2.441,10 | 1 |
| HPI4-300002 | 230 | 3.000 | 13 | EU | 50/60 | 3.193,00 | 1 |
| HPI4-300003 | 230 | 3.000 | 13 | UK | 50/60 | 3.193,00 | 1 |
| HPI4-300004 | 230 | 3.000 | 13 | CH | 50/60 | 3.193,00 | 1 |
| HPI4-380002 | 230 | 3.800 | 16.5 | EU | 50/60 | 3.808,80 | 1 |
| HPI4-380003 | 230 | 3.800 | 16 | UK | 50/60 | 3.808,80 | 1 |
| HPI4-380004 | 230 | 3.800 | 16.5 | CH | 50/60 | 3.808,80 | 1 |

Induction units 12.1

Placas de inducción
Plaque induction

mirage® INDUCTION

- 90 % Efficiency**
Eficiencia
Efficacité
- 100 Power levels**
Niveles de potencia
Niveaux de puissance
- 60-205 °C Temperature levels**
Niveles de temperatura
Niveaux de température
- 1-180 min Timer**
Temporizador
Minuterie
- Medium-duty usage**
Uso semi-intensivo
Semi-intensif usage

Temperature memory — powers up to the last used temperature setting.

Memoria de temperatura — permite usar el último ajuste de temperatura programado.

Mémoire de température — offre la possibilité d'utiliser le dernier réglage de température.

Ceramic glass cooking surface
Superficie de cocción de cristal vitrocerámico
Surface de cuisson vitrocéramique

Control knob with power and temperature level adjustment
Mando de selección de temperatura y potencia
Cadran de réglage de température et de puissance

Soft-touch control panel
Panel de control táctil
Panneau de commande tactile

Tough stainless steel case
Resistente caja de acero inoxidable
Boîtier inox solide



59650 Induction cooker Placa inducción Plaque induction



| REF | Ø Mâx cm | V | W | A | Plug Ench. | Hz | € / u | ☐ |
|-------|----------|-----|-------|-----|------------|-------|----------|---|
| 59650 | 26 | 230 | 1.800 | 7,8 | EU | 50/60 | 1.005,30 | 1 |
| 59651 | 26 | 230 | 1.800 | 7,8 | UK | 50/60 | 1.005,30 | 1 |

59601 Drop in induction cooker Placa inducción encastrable Plaque induction encastrable

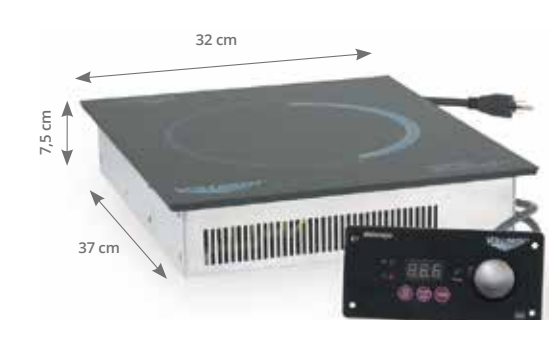

| REF | Ø Mâx cm | V | W | A | Plug Ench. | Hz | € / u | ☐ |
|-------|----------|-----|-------|-----|------------|-------|----------|---|
| 59601 | 30,5 | 230 | 1.800 | 7,8 | EU | 50/60 | 1.103,80 | 1 |
| 59602 | 30,5 | 230 | 1.800 | 7,8 | UK | 50/60 | 1.103,80 | 1 |

12.1 Induction units

Placas de inducción
Plaque induction

69547 Double induction plate
Placa inducción doble
Plaque à induction double

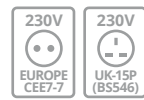

1.900W x 2



| REF | Ø cm | V | W | A | Plug Ench. | Hz | €/u | ⊠ |
|---------|--------|---------|-------|------|------------|-------|----------|---|
| 6954702 | 30 x 2 | 208-240 | 3.800 | 15,8 | EU | 50/60 | 2.305,45 | 1 |
| 6954703 | 30 x 2 | 208-240 | 3.800 | 15,8 | UK | 50/60 | 2.305,45 | 1 |

69523 Double induction plate
Placa inducción doble
Plaque à induction double



2.900W x 2



| REF | Ø cm | V | W | A | Plug Ench. | Hz | ⊠ |
|-------|--------|---------|-------|------|------------|-------|---|
| 69523 | 30 x 2 | 208-240 | 5.800 | 24,1 | NEMA | 50/60 | 1 |

P15078 Induction cooker
Placa de inducción
Plaque à induction



| REF | Ø Mx cm | V | W | Hz | €/u | ⊠ |
|--------|---------|-----------|-------|-------|--------|---|
| P15078 | 26 | 220 - 240 | 3.500 | 50/60 | 528,30 | 1 |

St/steel housing. Timer. LED display (0-180 minutes). Touch control. 1-10 Power level (500-3500W). Temperatures: 60-240 °C. Four fans.

Cuerpo en acero inoxidable. Reloj temporizador (0-180 minutos). Pantalla LED con control táctil. Regulador de temperatura 1-10 (500-3500W). Rango temperatura 60-240 °C. Cuatro ventiladores de refrigeración.

Corps en acier inoxydable. Minuteur. Ecran LED (0-180 minutes). Tactile. 1-10 Niveau de puissance (500-3500W). Temperatures: 60-240 °C. Quatre ventilateurs.

P15072 Induction cooker
Placa de inducción
Plaque à induction



| REF | Ø Mx cm | V | W | Hz | €/u | ⊠ |
|--------|---------|-----|-------|-------|--------|---|
| P15072 | 26 | 230 | 3.500 | 50/60 | 558,40 | 1 |

St/Steel housing. Digital regulation of time 0-180 minutes. Thermostat 60-240 °C and power 500-3500 W. 4 Fans.

Cuerpo en acero inoxidable. Mando digital de tiempo de 0-180 minutos. Temperatura de 60-240 °C. Potencia de 500-3500 W. 4 Ventiladores.

Corps en acier inoxydable. Minuterie digitale de 0-180 minutes. Température de 60-240 °C. Puissance: 500-3500 W. 4 Ventilateurs.

Induction units 12.1

Placas de inducción
Plaque induction

P15079 Induction cooker
Placa de inducción
Plaque à induction



| REF | Ø Mx cm | V | W | Hz | €/u | ⊠ |
|--------|---------|-----|-------|-------|--------|---|
| P15079 | 26 | 230 | 3.500 | 50/60 | 452,00 | 1 |

St/steel housing. Timer. LED display (0-180 minutes). Temperatures: 60-240 °C. One fan.

Cuerpo en acero inoxidable. Reloj temporizador (0-180 minutos). Pantalla LED. Rango temperatura 60-240 °C. Un ventilador de refrigeración.

Corps en acier inoxydable. Minuteur. Ecran LED (0-180 minutes). Temperatures: 60-240 °C. Un ventilateur.

P15077 Induction cooker
Placa de inducción pequeña
Plaque induction petite



| REF | Ø Mx cm | V | W | Hz | €/u | ⊠ |
|--------|---------|-----|-------|-------|--------|---|
| P15077 | 26 | 230 | 2.000 | 50/60 | 211,45 | 1 |

Plastic housing with touch control LCD panel. Timer (0-180 minutes). Temperatures: 60-240 °C.

Cuerpo en plástico con panel control táctil LCD. Reloj temporizador (0-180 minutos). Rango temperaturas: 60-240 °C.

Corps en plastique avec écran LCD tactile. Minuteur (0-180 minutes). Temperatures: 60-240 °C.

P688065 Wok induction cooker
Placa de inducción wok
Plaque à induction wok



| REF | Ø cm | V | W | Plug Ench. | Hz | €/u | ⊠ |
|---------|-------|---------|-------|------------|-------|--------|---|
| P688065 | 36/40 | 220-240 | 3.100 | EU | 50/60 | 628,10 | 1 |

St/steel housing. Timer (0-180 minutes). LED display. Temperatures: 60-240 °C. 4 fans.

Cuerpo en acero inoxidable. Reloj temporizador (0-180 minutos). Pantalla LED. Temperatura 60-240 °C. 4 ventiladores.

Corps en acier inoxydable. Minuteur (0-180 minutes). Ecran LED. Temperatures: 60-240 °C. 4 ventilateurs.

6958302 Placa de inducción control wok 35 cm
Placa de inducción wok 35 cm
Plaque à induction contrôle wok 35 cm



| REF | CA/AC Volt. | W | A | Plug Ench. | Hz | €/u | ⊠ |
|---------|-------------|------|------|------------|-------|----------|---|
| 6958302 | 208-240 | 3000 | 14.6 | EU | 50/60 | 5.625,00 | 1 |
| 6958303 | 208-240 | 3000 | 14.6 | UK | 50/60 | 5.625,00 | 1 |

Includes a carbon steel wok. High efficiency of induction to provide gas-like performance. 100 power settings for precise cooking control.

Incluye un wok de acero al carbono. Alta eficiencia de inducción para proporcionar un rendimiento similar al del gas. 100 configuraciones de potencia para un control preciso de la cocción.

Comprend une poêle wok en acier au carbone. Haute efficacité d'induction pour fournir des performances similaires à celles d'un gaz. 100 réglages de puissance pour un contrôle précis de la cuisson.

12.1 Warming induction units

Placas inducción mantenedoras
Plaque induction de maintien température

mirage[®]
INDUCTION



BUFFET INDUCTION WARMER BUFET CALENTADORES INDUCCIÓN BUFFET RECHAUD INDUCTION

Low wattage to keep food warm during serving.
Mantener la comida caliente durante el servicio.
Faible puissance pour garder les aliments au chaud pendant le service.

With less than 400W, it is the most efficient and eco-friendly system on the market.

Con menos de 400W son el sistema más eficiente y eco-friendly del mercado.

Avec moins de 400 W c'est le système le plus efficace et eco-friendly du marché.



Tempered, black glass top.
Parte superior de cristal templado negro.
Plateau en verre noir trempé.

Touch control, 4 power settings. LED indicator lights on control panel & glass.
Con 4 ajustes de potencia. Indicadores luminosos LED en el panel de control.
Contrôle tactile, 4 réglages de puissance. Voyants LED lumineux sur le panneau de commande et verre.



Connect up to 3 units together with interconnect cords.
Conecte hasta 3 placas a la vez.
Connectez jusqu'à 3 unités avec des cordons d'interconnexion.

Warming induction units 12.1

Placas inducción mantenedoras
Plaque induction de maintien température

595027502 Buffet induction warmer Placa inducción mantenedora de temperatura Plaque induction de maintien température



595087502
595087503



595027502
595027503

| REF | WxDxH cm | CA/AC Volt. | W | A | Plug Ench. | Hz | € / u | u |
|-----------|-------------|----------------|-----|------|---------------|-------|----------|---|
| 595027502 | 40x40x8 | 230 | 300 | 1,30 | EU | 50/60 | 1.078,50 | 1 |
| 595027503 | 40x40x8 | 230 | 300 | 1,30 | UK | 50/60 | 1.078,50 | 1 |
| 595087502 | 60x40x8 | 230 | 375 | 1,63 | EU | 50/60 | 1.345,60 | 1 |
| 595087503 | 60x40x8 | 230 | 375 | 1,63 | UK | 50/60 | 1.345,60 | 1 |

59641 Drop in warmer Placa inducción mantenedora de temperatura encastrable Plaque induction de maintien température encastrable



* Drop in
Encastrable
Encastrable

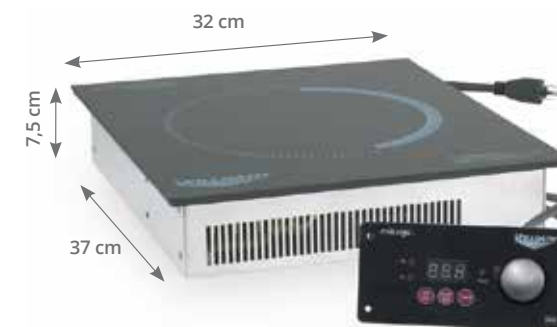

| REF | Ø Màx cm | cm* | CA/AC Volt. | W | A | Plug Ench. | Hz | € / u | u |
|-------|-------------|---------|----------------|-----|-----|---------------|-------|----------|---|
| 59641 | 36 | 34 x 30 | 230 | 650 | 2,8 | EU | 50/60 | 1.096,85 | 1 |
| 59642 | 36 | 34 x 30 | 230 | 650 | 2,8 | UK | 50/60 | 1.096,85 | 1 |

12.1 Ovens & micro-waves

Hornos y micro-ondas
Fours et micro-ondes

P15035 Convection oven
Horno multifuncional de convección
Four à air pulse



| REF | Grill Rejilla Grille | V | W | Hz | €/u | 📦 |
|---------------|----------------------------|-----|-------|-------|----------|---|
| P15035 | 43 x 32 | 230 | 2.670 | 50/60 | 1.027,65 | 1 |

4 grids included
4 rejillas incluidas
4 grilles incluses

Timer, indicator lights, thermostat, (max. 300 °C) thermal cut-out and double glass.

Temporizador, pilotos luminosos, termostato (max. 300 °C), termostato de seguridad y doble vidrio anti-quemaduras.

Avec minuterie, voyants lumineux, thermostat (max. 300 °C), thermostat de sécurité et avec double vitre. mostat, thermostat de sécurité et avec vitre double

P688085 Rice cooker
Hervidor de arroz
Cuiseur à riz



| REF | Ø cm | Rice cap. Cap. arroz Riz cap. Kg | Lts | H cm | V | W | Hz | €/u | 📦 |
|----------------|------|---|------|------|---------|------|-------|--------|---|
| P688085 | 46 | 3,0 | 5,40 | 40 | 220-230 | 1950 | 50/60 | 420,15 | 1 |
| P688087 | 56 | 6,1 | 8,20 | 40 | 220-240 | 2500 | 50/60 | 577,50 | 1 |

P15081 Combi micro - wave
Microondas combi
Four micro - ondes



10 Power levels
Niveles de potencia
Niveaux de puissance



| REF | Lts | Inner sizes Dim int Dim. int. cm | V | Max W | Hz | €/u | 📦 |
|---------------|------|--|-----|-------|----|--------|---|
| P15081 | 25,0 | 33,5 x 33,5 x 17 | 230 | 1.950 | 50 | 472,55 | 1 |

Input: 1.400 W
Output: 900 W
Convection / Convección: 1.950 W

Glass round dish 27 cm diameter
Plato giratorio 27 cm diametro
Plateau tournant 27 cm diametre

Functions: defrosting, baking and heating
Funciones: descongelar, gratinar y calentar
Fonctions: décongeler, gratiner et chauffer

P15075 Crêpe maker
Crêpera
Crêpière

Thermostat
Termostato
Thermostat:
Temp. Max 300 °C



St/Steel with cast iron teflon coated plates. Indicator light, drawer/warming tray and batter spreader.

Acero inoxidable con planchas de hierro fundido teflonadas.
Indicador temperatura, cajón y espátula.

Acier inoxydable avec plaques en fonte avec revêtement en téflon.
Témoin de controle, tiroir/plaque chauffante et étaleur de pâte.

| REF | Ø cm | cm | V | W | Hz | €/u | 📦 |
|---------------|------|---------|-----|-------|-------|--------|---|
| P15075 | 40 | 45 x 49 | 230 | 3.000 | 50/60 | 910,75 | 1 |

Fryers 12.1

Freidoras
Friteuses

18/10
Stainless
steel

Temperature control up to 190°C
Temperatura variable hasta 190°C
Température variable jusqu'à 190°C

P15070 5 Lts fryer
Freidora 5 Lts
Friteuse 5 Lts

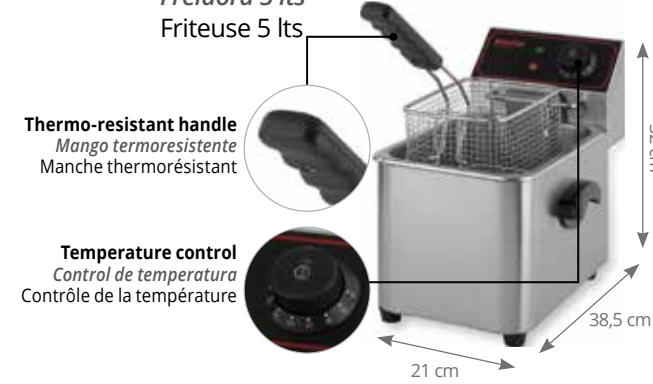

| REF | Lts | V | W | Hz | €/u | 📦 |
|---------------|------|-----|-------|-------|--------|---|
| P15070 | 5,00 | 230 | 2.000 | 50/60 | 307,30 | 1 |

Basket size / Medida cesta / Mesure panier 21 x 14 x 12,5 cm

P15000 8 Lts Fryer
Freidora 8 Lts
Friteuse 8 Lts



| REF | Lts | V | W | Hz | €/u | 📦 |
|---------------|------|-----|-------|-------|--------|---|
| P15000 | 8,00 | 230 | 3.250 | 50/60 | 384,90 | 1 |

Basket size / Medida cesta / Mesure panier 24 x 18 x 14 cm

P15002 8 Lts fryer with drainage tap
Freidora 8 Lts con grifo de vaciado
Friteuse 8 Lts avec robinet vidange



| REF | Lts | V | W | Hz | €/u | 📦 |
|---------------|------|-----|-------|-------|--------|---|
| P15002 | 8,00 | 230 | 3.250 | 50/60 | 560,95 | 1 |

Basket size / Medida cesta / Mesure panier 24 x 18 x 14 cm

P15071 5+5 Lts fryer
Freidora 5+5 Lts
Friteuse 5+5 Lts



| REF | Lts | V | W | Hz | €/u | 📦 |
|---------------|-----------|---------|-----------|-------|--------|---|
| P15071 | 5,00+5,00 | 2 x 230 | 2 x 2.000 | 50/60 | 620,40 | 1 |

Basket size / Medida cesta / Mesure panier 21 x 14 x 12,5 cm

P15001 8+8 Lts Fryer
Freidora 8+8 Lts
Friteuse 8+8 Lts



| REF | Lts | V | W | Hz | €/u | 📦 |
|---------------|-----------|---------|-----------|-------|--------|---|
| P15001 | 8,00+8,00 | 2 x 230 | 2 x 3.250 | 50/60 | 776,50 | 1 |

Basket size / Medida cesta / Mesure panier 24 x 18 x 14 cm

P15003 8+8 Lts fryer with drainage tap
Freidora 8+8 Lts con grifo de vaciado
Friteuse 8+8 Lts avec robinet vidange



| REF | Lts | V | W | Hz | €/u | 📦 |
|---------------|-----------|---------|-----------|-------|--------|---|
| P15003 | 8,00+8,00 | 2 x 230 | 2 x 3.250 | 50/60 | 972,00 | 1 |

Basket size / Medida cesta / Mesure panier 24 x 18 x 14 cm

12.2 Toasters

Tostadoras
Toaster



CT4-230DUAL Dual conveyor toaster
Tostadora transportadora doble
Pain double à convoyeur



NEW!



Conveyor width
Ancho de cinta
Largeur de bande
36,8 cm

Delivered without plug (stripped ends).
Entregado sin clavija.
Livré sans prise.

1100
Slices per hour
Rebanadas por hora
Tranches heure

| REF | V | W | Hz | A | €/u | |
|-------------|---------|-------|-------|------|----------|---|
| CT4-230DUAL | 220-240 | 4.950 | 50/60 | 19,8 | 5.574,70 | 1 |

Save up to 75% energy*
Ahorre hasta un 75% de energía*
Économisez jusqu'à 75% d'énergie*

CONVEYOR TOASTERS
Forced convection and energy-efficient quartz resistors provide a uniform and fast toasting.

* The Stand by function saves 75% of energy during periods of low demand.

TOSTADORAS CON CORREA TRANSPORTADORA
La convección forzada y las resistencias de cuarzo energéticamente eficientes brindan un tostado uniforme y rápido.

*La función en Stand by permite ahorrar un 75% de energía en el momento de baja demanda.

GRILLE-PAIN CONVOYEURS
La convection forcée et les résistances à quartz énergétiquement efficaces offrent un grillage uniforme et rapide.

*La fonction Stand by permet d'économiser 75% d'énergie aux moments de faible demande.

CT4H-230950 Conveyor toaster
Tostadora continua
Pain à convoyeur



NEW!



Conveyor width
Ancho de cinta
Largeur de bande
36,8 cm

Delivered without plug (stripped ends).
Entregado sin clavija.
Livré sans prise.

950
Slices per hour
Rebanadas por hora
Tranches heure

| REF | V | W | Hz | A | €/u | |
|-------------|---------|-------|-------|------|----------|---|
| CT4H-230950 | 220-240 | 3.600 | 50/60 | 14,4 | 3.087,30 | 1 |

18/10
Stainless steel

CT4-3600W Conveyor toaster
Tostadora continua
Grille - pain à convoyeur



Speed control
Control de velocidad
Contrôle de vitesse

Stand-by system
Sistema stand-by
Système stand-by

Temperature control
Control de temperatura
Contrôle de la température

Conveyor width
Ancho de cinta
Largeur de bande
35,6 cm

Delivered without plug (stripped ends).
Entregado sin clavija.
Livré sans prise.

Replaceable quartz resistance.
Resistencias de cuarzo recambiables.
Résistances à quartz remplaçables.

1.000
Rebanadas por hora
Slices per hour
Tranches heure

| REF | V | W | Hz | A | WxDxH cm | Plug Ench. | €/u | |
|-------------|-----|-------|-------|----|------------|------------|-----|--|
| CT4-2301000 | 230 | 3.600 | 50/60 | 15 | 35x46x35,6 | 2.541,90 | 1 | |

CT2-1500W Conveyor toaster
Tostadora continua
Grille - pain à convoyeur

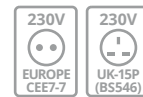

Conveyor width
Ancho de cinta
Largeur de bande
26,7 cm



CT4-2800W Conveyor toaster
Tostadora continua
Grille - pain à convoyeur

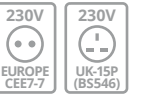

Speed and temperature control.
Replaceable quartz resistance.

Dispone de control de velocidad y temperatura.
Resistencias de cuarzo recambiables.

Avec contrôle de la vitesse et température. Résistances à quartz remplaçables.

Conveyor width
Ancho de cinta
Largeur de bande
26,7 cm

450-800
Slices per hour
Rebanadas por hora
Tranches heure

| REF | V | W | Hz | A | WxDxH cm | Plug Ench. | €/u | |
|--------------|-----|-------|-------|------|----------|------------|----------|---|
| CT4-23080002 | 230 | 2.800 | 50/60 | 12,7 | 35x36x60 | EU | 2.099,65 | 1 |
| CT4-23080003 | 230 | 2.800 | 50/60 | 12,7 | 35x36x60 | UK | 2.099,65 | 1 |

| REF | V | W | Hz | A | WxDxH cm | Plug Ench. | €/u | |
|--------------|-----|-------|-------|------|----------|------------|----------|---|
| CT2-23035002 | 230 | 1.500 | 50/60 | 12,5 | 35x36x41 | EU | 1.829,50 | 1 |
| CT2-23035003 | 230 | 1.500 | 50/60 | 12,5 | 35x36x41 | UK | 1.829,50 | 1 |

350
Slices per hour
Rebanadas por hora
Tranches heure

Speed control.
Replaceable quartz resistance.

Dispone de control de velocidad.
Resistencias de cuarzo recambiables.

Avec contrôle de la vitesse.
Résistances à quartz remplaçables.

12.2 Toasters

Tostadoras
Toaster

SS
Stainless
steel

Conveyor heating oven / Horno de cinta / Four chauffant à bande

Designed to heat any type of snack and melt cheese quickly and efficiently. Made of stainless steel with a variable speed control system and temperature control both above and below the conveyor belt. It includes a crumb collection tray. It has a forced convection system and has the possibility of regulating the height of the belt, ensuring uniform toasting and the highest energy efficiency. Two units can be mounted one top of the other with a space-saving accessory.

Diseñado para calentar cualquier tipo de snack y fundir queso de manera rápida y eficiente. Fabricado en acero inoxidable con un sistema de control de la velocidad variable y control de temperatura tanto por encima como por debajo de la cinta. Incluye bandeja para recoger migas. Su sistema de convección forzada y la posibilidad de regular la altura de la cinta, aseguran un tostado uniforme y la mayor eficiencia energética. Pueden remontarse dos unidades al mismo tiempo con un accesorio para ahorrar espacio.

Conçue pour préparer toute sorte de snack et faire fondre le fromage rapidement et efficacement. Fabriqué en acier inoxydable avec un système de contrôle de vitesse variable et un contrôle de température au-dessus comme en-dessous de la bande. Inclut bac de récupération de miettes. Son système de convection forcée et la possibilité de régler la hauteur de la bande, assurent un grillé uniforme et la meilleure efficacité énergétique. Il est possible de remonter deux unités à la fois avec un accessoire pour économiser de l'espace.

SO2-2800W Conveyor heating oven Horno calentador de cinta Four chauffant à bande

CE



26,7 cm

Belt width / Ancho de cinta
Largeur de la bande

3,8 - 7,6 cm

Adjustable entrance height
Altura entrada ajustable
Hauteur de l'entrée réglable

| REF | V | W | Hz | A | WxDxH cm | Plug Ench. | €/u | ⊞ |
|-------------|-----|-------|----|------|-------------|---------------|----------|---|
| SO2-23010.5 | 230 | 2.800 | 50 | 13,3 | 34x104x41 | EU | 2.951,45 | 1 |

SO2-3600W Conveyor heating oven Horno calentador de cinta Four chauffant à bande

CE



36,8 cm

Belt width / Ancho de cinta
Largeur de la bande

3,8 - 7,6 cm

Adjustable entrance height
Altura entrada ajustable
Hauteur de l'entrée réglable

| REF | V | W | Hz | A | WxDxH cm | Plug Ench. | €/u | ⊞ |
|-------------|-----|-------|----|------|-------------|---------------|----------|---|
| SO2-23014.5 | 230 | 3.600 | 50 | 13,3 | 39x103,5x51 | EU | 3.391,05 | 1 |

See products on / Ver productos en / Voir produits en page

P. 446

Wooden bread spoon
Pinza de pan de madera
Pince à pain en bois



Idea! Ideal for handling toast
Ideal para manipular las tostadas
Idéal pour manipuler le pain grillé

Toasters 12.2

Tostadoras
Toaster

SS
Stainless
steel

Standard Toasters / Tostadoras Estándar / Toasteurs Standard

P15042 Conveyor toaster Tostadora continua Toasteur convoyeur

CE



500

Rebanadas por hora
Slices per hour
Tranches heure

P15038 Sandwich toaster Tostadora Toasteur

CE



80-100

Slices per hour
Rebanadas por hora
Tranches heure

Delivered with 3 sandwich tongs
Se entregan con 3 pinzas para sandwich
Livrées avec 3 pinces à sandwich

| REF | V | W | Hz | €/u | ⊞ |
|--------|-----|-------|-------|--------|---|
| P15038 | 230 | 1.700 | 50/60 | 406,20 | 1 |

Heating elements separately controllable. With timer, drip tray and 4 quartz heating elements.

Las resistencias se pueden controlar por separado. Con temporizador y bandeja limpieza recoge migas. 4 tubos de cuarzo.

Les résistances se contrôlent séparément. Avec minuterie, tiroir ramasse miettes et 4 tubes quartz.

| REF | V | W | Hz | €/u | ⊞ |
|--------|-----|-------|-------|----------|---|
| P15042 | 230 | 2.240 | 50/60 | 1.395,45 | 1 |

Toast colour can be determined by conveyor speed as well as by independently controlled heating elements. Units are fully insulated to emit only minimal heat to surroundings. Main switch with extra standby position. The toasters can be used for bread as well as for buns. The toasting belt is suitable for 2 rows for toast, 200 type.

El color de las tostadas puede determinarse por la velocidad de la banda transportadora, así como por las resistencias superior e inferior que se controlan independientemente. El aparato está completamente aislado para que emita un calor mínimo a su alrededor. El interruptor encendido-apagado contempla la posición extra de standby. La longitud de la banda transportadora permite 2 hileras de tostadas (tipo 200).

La couleur du pain se détermine par la vitesse de la bande de transport ainsi que par les résistances contrôlées indépendamment. Les appareils sont isolés entièrement et n'émettent qu'une chaleur minimale à la température ambiante. Interrupteur marche-arrêt qui inclut le mode veille standby. La Largeur de la bande de transport permet 2 rangées de tranches, type 200.

P15039 Sandwich toaster Tostadora Toasteur

CE



120-130

Slices per hour
Rebanadas por hora
Tranches heure

Delivered with 6 sandwich tongs
Se entregan con 6 pinzas para sandwich
Livrées avec 6 pinces à sandwich

| REF | V | W | Hz | €/u | ⊞ |
|--------|-----|-------|-------|--------|---|
| P15039 | 230 | 3.000 | 50/60 | 465,35 | 1 |

2 levels. Heating elements separately controllable. With timer, drip tray and 9 quartz heating elements.

2 niveles. Las resistencias funcionan por separado. Con temporizador, bandeja recoge migas. 9 tubos de cuarzo.

2 niveaux. Les résistances se contrôlent séparément. Avec minuterie, tiroir ramasse miettes et 9 tubes quartz.

12.2 Toasters

Tostadoras
Toaster

P15040 Toaster
Tostadora
Toasteur



120
Rebanadas por hora
Slices per hour
Tranches heure

| REF | Slots Ranuras Fentes | V | W | Hz | €/u | |
|--------|----------------------------|-----|-------|-------|--------|---|
| P15040 | 4 | 230 | 1.800 | 50/60 | 301,85 | 1 |

With manual pop up
Con expulsión manual
Avec éjection automatique

All St/Steel construction.
With energy-saving switch to decide how many slices to toast. With timer: 2 or 4
Slot: 2,5 x 14,5 x 14,5 cm.

Fabricada en acero inoxidable.
Con conmutador ahorro energía para decidir la cantidad de rebanadas a tostar: 2 ó 4
Con temporizador.
Ranura: 2,5 x 14,5 x 14,5 cm.

Habillage en acier inoxydable.
Avec commutateur économiseur pour choisir le nombre de tranches à griller: 2 ou 4.
Avec minuterie.
Fente: 2,5 x 14,5 x 14,5 cm.

P15041 Toaster
Tostadora
Toasteur



180
Rebanadas por hora
Slices per hour
Tranches heure

| REF | Slots Ranuras Fentes | V | W | Hz | €/u | |
|--------|----------------------------|-----|-------|-------|--------|---|
| P15041 | 6 | 230 | 2.500 | 50/60 | 374,25 | 1 |

With manual pop up
Con expulsión manual
Avec éjection automatique

All St/Steel construction.
With energy-saving switch to decide how many slices to toast. With timer: 2 or 4 or 6
Slot: 2,5 x 14,5 x 14,5 cm.

Fabricada en acero inoxidable.
Con conmutador ahorro energía para decidir la cantidad de rebanadas a tostar: 2 ó 4 ó 6
Con temporizador.
Ranura: 2,5 x 14,5 x 14,5 cm.

Habillage en acier inoxydable.
Avec commutateur économiseur pour choisir le nombre de tranches à griller: 2 ou 4 ou 6
Avec minuterie.
Fente: 2,5 x 14,5 x 14,5 cm.

Contact grill 12.2

Grill de contacto
Grill de contact



CAST IRON GRIDDLE PLATES ENAMELED.
Large drip tray.
High turned-up spatter rim.
Indicator lights.
Adjustable thermostat to 300 °C.

PLANCHAS DE FUNDICIÓN ESMALTADAS.
Bandeja y recoge jugos.
Borde antisalpicaduras.
Luces piloto.
Termostato ajustable hasta 300 °C.

PLAQUE EN FONTE EMAILLÉES.
Tiroir de propreté.
Bourdre anti projections haute.
Voyants lumineux.
Thermostat réglable jusqu'à 300 °C.

P15004 "Solo compact" Contact grill
Grill de contacto "Solo compact"
Grill de contact "Solo compact"



Upper and lower grooves
Ranura arriba y abajo
Quadrillage en haut et en bas



Temperature control
Control de temperatura
Contrôle de la température



Fat collection tray
Bandeja recoge grasa
Bac de récupération de graisse

| REF | Cooking surface Superficie de cocción Surface de cuisson cm | V | W | Hz | €/u | |
|--------|--|-----|-------|-------|--------|---|
| P15004 | 22 x 23 | 230 | 1.800 | 50/60 | 558,90 | 1 |

P15005 "Solo grande" Contact grill
P15006 Grill de contacto "Solo grande"
Grill de contact "Solo grande"



Upper and lower grooves
Ranura arriba y abajo
Quadrillage en haut et en bas
P15005

Upper groove
Ranura arriba
Quadrillage en haut
P15006

| REF | Cooking surface Superficie de cocción Surface de cuisson cm | V | W | Hz | €/u | |
|--------|--|-----|-------|-------|--------|---|
| P15005 | 32 x 21 | 230 | 2.200 | 50/60 | 602,35 | 1 |
| P15006 | 32 x 21 | 230 | 2.200 | 50/60 | 602,35 | 1 |

P15007 "Duetto compact" Contact grill
P15008 Grill de contacto "Duetto compact"
Grill de contact "Duetto compact"



Upper and lower grooves
Ranura arriba y abajo
Quadrillage en haut et en bas
P15007

Upper groove
Ranura arriba
Quadrillage en haut
P15008

| REF | Cooking surface Superficie de cocción Surface de cuisson cm | V | W | Hz | €/u | |
|--------|--|-----|-------|-------|--------|---|
| P15007 | 47 x 23 | 230 | 3.600 | 50/60 | 919,50 | 1 |
| P15008 | 47 x 23 | 230 | 3.600 | 50/60 | 919,50 | 1 |

Included on the price
Incluido en el precio
Inclus dans le prix



P818000

12.3 Mixers

Batidoras planetarias
Mélangeurs

Mixers Batidoras planetarias Mélangeurs

Gears and shafts are made of heat-treated alloy steel for long life and quieter operation

Engranajes y ejes de acero de fundición permiten alargar la vida del producto y proporcionan un funcionamiento más silencioso

Engrenages et arbres en acier allié traité à la chaleur pour une longue durée et un fonctionnement plus silencieux

Planetary mixing action

Acción de batido elíptico
Mélangeur planétaire



Thermal overload protection automatically shuts off mixer to protect from damage

Paro automático por sobre calentamiento
Arrêt automatique par la surchauffe

30 minute digital timer with automatic stop and audible shutoff signal

Temporizador digital 30 minutos, con paro automático con señal acústica

Minuterie numérique (30 minutes) à arrêt automatique et signal d'arrêt sonore

Consistent mixing speeds regardless of volume

Velocidades de mezcla constantes independientemente del volumen

Vitesses de mélange uniformes, quel que soit le volume

Safety guard

Protección Seguridad
Protecteur de sécurité

Heavy-duty construction

Construcción extra robusta
Construction robuste

Comes with / Incluye / Livré avec



Wire Wishk
Batidor varilla
Fouet à fil



Dough hook
Gancho para masa
Crochet de pâte



Spatula
Espátula
Spatule



S/Steel mixing bowl
Bol acero inoxidable
Bol mélangeur en acier inoxydable



4075502 Countertop Mixers Amasadora sobre mesa Mélangeurs de comptoir

1/3 HP
250 W
3 A
50 Hz



4075503

Digital control panel to make easy speed shifts while unit is running.
Panel de control digital para simplificar el cambio de velocidades mientras la unidad está funcionando.

Panneau de commande numérique pour faciliter les changements de vitesse pendant le fonctionnement de l'appareil

| REF | Lts. | W x D x H cm | Speed Velocidad Vitesse | V | Plug Ench. | € / u | ☐ |
|---------|------|--------------|-------------------------|---------|------------|----------|---|
| 4075502 | 6,6 | 33,5x45x51,5 | 5 | 220-230 | EU | 2.093,10 | 1 |
| 4075503 | 6,6 | 33,5x45x51,5 | 5 | 220-230 | UK | 2.093,10 | 1 |
| 4075602 | 9,5 | 33,5x45x54 | 5 | 220-230 | EU | 2.344,10 | 1 |
| 4075603 | 9,5 | 33,5x45x54 | 5 | 220-230 | UK | 2.344,10 | 1 |

| REF | For / Para / Pour (Lts) | € / u | ☐ |
|--|-------------------------|--------|---|
| Wire Wishk / Batidor varilla / Fouet à fil | | | |
| XMIX0705 | 6.6 | 158,70 | 1 |
| 40762 | 9.5 | 136,05 | 1 |
| Dough hook / Gancho para masa / Crochet de pâte | | | |
| XMIX0704 | 6.6 | 137,30 | 1 |
| 40763 | 9.5 | 137,30 | 1 |
| Spatula / Espátula / Spatule | | | |
| XMIX0703 | 6.6 | 128,65 | 1 |
| 40764 | 9.5 | 128,65 | 1 |
| Mixing bowl / Bol acero / Bol mélangeur | | | |
| XMIX0702 | 6.6 | 342,65 | 1 |
| 40761 | 9.5 | 266,80 | 1 |

Slicing machines 12.3

Corta fiambres
Trancheurs

4075702 Floor-Bench mixers Amasadora de pié Mélangeurs au sol-sur plan de travail



220-230 V
50 Hz



4075702

| REF | Lts. | W x D x H cm | Speed Velocidad Vitesse | HP | W | A | Plug Ench. | € / u | ☐ |
|---------|------|--------------|-------------------------|-----|-------|----|------------|----------|---|
| 4075702 | 19 | 52x52x91 | 3 | 0,5 | 370 | 4 | EU | 4.552,95 | 1 |
| 4075703 | 19 | 52x52x91 | 3 | 0,5 | 370 | 4 | UK | 4.552,95 | 1 |
| 4075802 | 28 | 64x62x122 | 3 | 1,0 | 750 | 8 | EU | 7.151,35 | 1 |
| 4075803 | 28 | 64x62x122 | 3 | 1,0 | 750 | 8 | UK | 7.151,35 | 1 |
| 4075902 | 38 | 68x68x120 | 3 | 1,5 | 1.120 | 11 | EU | 9.758,00 | 1 |
| 4075903 | 38 | 68x68x120 | 3 | 1,5 | 1.120 | 11 | UK | 9.758,00 | 1 |

| REF | For / Para / Pour (Lts) | € / u | ☐ |
|--|-------------------------|----------|---|
| Wire Wishk / Batidor varilla / Fouet à fil | | | |
| 40766 | 19 | 200,30 | 1 |
| 40770 | 28 | 621,60 | 1 |
| 40774 | 38 | 877,95 | 1 |
| Dough hook / Gancho para masa / Crochet de pâte | | | |
| 40767 | 19 | 185,55 | 1 |
| 40771 | 28 | 550,85 | 1 |
| 40775 | 38 | 644,25 | 1 |
| Spatula / Espátula / Spatule | | | |
| 40768 | 19 | 185,55 | 1 |
| 40772 | 28 | 471,55 | 1 |
| 40776 | 38 | 644,25 | 1 |
| Mixing bowl / Bol acero / Bol mélangeur | | | |
| 40765 | 19 | 426,15 | 1 |
| 40769 | 28 | 1.602,95 | 1 |
| 40773 | 38 | 1.799,70 | 1 |

P15089 / P15090 / P15091 Electric slicing machine Cortadora eléctrica de fiambres Tranchar électrique



Body: painted aluminium.
Cuerpo: aluminio pintado.
Corps: aluminium peint.

| REF | V | Hz | W | Ø Blade Cuchilla /Lame | Slicer thickness Espesor corte /Épaisseur de coupe | W x D x H cm | Kg | € / u | ☐ |
|--------|-----|----|-----|------------------------|--|--------------|------|----------|---|
| P15089 | 230 | 50 | 120 | 22 | 0-9 | 48 x 40 x 37 | 14,8 | 585,40 | 1 |
| P15090 | 230 | 50 | 150 | 25 | 0-9 | 48 x 40 x 37 | 16,0 | 702,85 | 1 |
| P15091 | 230 | 50 | 250 | 30 | 0-11 | 59 x 38 x 43 | 22,6 | 1.126,35 | 1 |



P15089
Ø 22 cm Blade / Cuchilla / Lame



P15090
Ø 25 cm Blade / Cuchilla / Lame



P15091
Ø 30 cm Blade / Cuchilla / Lame

See products on / Ver productos en / Voir produits en page

P. 141

Sanitary gel lubricant
Gel lubricante sanitario
Gel lubrifiant sanitaire



Which warming equipment do you need?

¿Qué mantenedor de temperatura necesitas?
 Quel appareil maintenance de température vous faut-il ?



Rethermalizers *Application: Retherm Chilled Food. Hold Heated Food.*
Rethermalizadores *Aplicación: Retermaliza alimentos fríos. Mantiene calientes los alimentos.*
Ap. de remise en température *Aplicación: Retermaliza alimentos fríos. Mantiene calientes los alimentos.*

Warmers *Application: Hold Heated Food.*
Calentadores *Aplicación: Mantiene calientes los alimentos.*
Chaud *Application: Tenir les aliments chauffés.*

| | INDUCTION 3D | RETRO | CAYENNE | CAYENNE |
|--|--|---|--|----------------|
|  |  |  |  | |
| Warmer and rethermalizer <i>Calentadores y rethermalizadores</i> Ap. de remise à température et ap. de maintien à température | ✓ | ✓ | ✓ | ✓ |
| Warmer only <i>Solo calentador</i> Chauffant seulement | | | | |
| Power (W) <i>Potencia (W)</i> Puissance (W) | 800 | 1.400 | 800 | 1.000 |
| Direct contact heating system <i>Calentamiento a través de contacto directo</i> Système de chauffage par contact direct | | | ✓ | ✓ |
| Water <i>Agua</i> Eau | | ✓ | ✓ | ✓ |
| Low water light <i>Luz indicadora nivel de agua bajo</i> Contrôle du niveau d'eau par voyant lumineux | | | ✓ | ✓ |
| Induction <i>Inducción</i> Induction | ✓ | | | |
| Capacity (L) <i>Capacidad (L)</i> Capacité (L) | 6,6 - 10,4 | 6,6 - 10,4 | 6,6 - 10,4 | 20 |
| Temperature control <i>Control de temperatura</i> Contrôle de température | ✓ | ✓ | ✓ | ✓ |

| | SOUP KETTLE <i>OLLA ELÉCTRICA / MARMITE CHAUD</i> | BAIN MARIE <i>BAÑO MARÍA / BAIN MARIE</i> | CHAFING DISH |
|--|--|--|---------------------|
|  |  |  | |
| | ✓ | ✓ | ✓ |
| | 400 | 1200 | 0 |
| | ✓ | ✓ | ✓ |
| | 10 | 20 | 9 |
| | ✓ | ✓ | |

EQUIPMENT
MAQUINARIA
EQUIPEMENT

EQUIPMENT
MAQUINARIA
EQUIPEMENT

12.4 Rethermalizers

Retermalizadores
Appareil de remise en température

INDUCTION 3D

RETHERMALIZER

MIRAGE®



Low power, 3D induction, without the need to use water.
Rapid heating time (50-60 min).
Food does not need to be pre-heated.
Directly from the freezer to the Rethermalizer.
Pre-selection menu and precise temperature regulator.

Inducción 3D de bajo consumo, sin necesidad de utilizar agua.
Tiempo de rethermalización rápido (50-60 min).
Los alimentos no necesitan ser precalentados.
Directamente del congelador al Retermalizador.
Menú de preselección y regulador de temperatura preciso.

Induction 3D basse consommation, sans nécessité d'utiliser de l'eau.
Temps de rethermalisation rapide (50-60 min).
Les aliments n'ont pas besoin d'être préchauffés.
Directement du congélateur au rethermalisateur.
Menu de présélection et régulateur de température précis.

Rethermalizers 12.4

Retermalizadores
Appareil de remise en température

747-7411 Mirage® Induction Rethermalizers
Retermalizador de inducción Mirage®
Appareil de remise en température à induction Mirage®

CE



800 W
3,5 A
50/60Hz



| REF | L | Ø cm | H cm | Prof. cm | Volt. CA / AC | Plug Ench. | € / u | ☐ |
|----------|------|------|------|----------|---------------|------------|----------|---|
| 7470210 | 6,6 | 30,3 | 34,2 | 17,6 | 230 | EU | 1.033,60 | 1 |
| 7470240 | 6,6 | 30,3 | 34,2 | 17,6 | 230 | EU | 1.033,60 | 1 |
| 7470310 | 6,6 | 30,3 | 34,2 | 17,6 | 230 | UK | 1.033,60 | 1 |
| 7470340 | 6,6 | 30,3 | 34,2 | 17,6 | 230 | UK | 1.033,60 | 1 |
| 74110210 | 10,4 | 35,3 | 34,2 | 17,6 | 230 | EU | 1.060,20 | 1 |
| 74110240 | 10,4 | 35,3 | 34,2 | 17,6 | 230 | EU | 1.060,20 | 1 |
| 74110310 | 10,4 | 35,3 | 34,2 | 17,6 | 230 | UK | 1.060,20 | 1 |
| 74110340 | 10,4 | 35,3 | 34,2 | 17,6 | 230 | UK | 1.060,20 | 1 |

Natural / Naturel
 Red / Rojo / Rouge



88184 Induction ready inserts for Mirage® 3D Induction Rethermalizers
Cubetas aptas para Retermalizadores Mirage® 3D
Conteneur pour Appareil de remise de température Mirage® 3D



| REF | L | Fits opening Para abertura cm | Prof. cm | € / u | ☐ |
|-------|------|-------------------------------|----------|-------|---|
| 88184 | 6,6 | 21,6 | 20,8 | 80,50 | 6 |
| 88204 | 10,4 | 26,7 | 20,8 | 89,65 | 6 |

747D-7411D Mirage® Drop-In Induction Rethermalizer
Retermalizador de inducción Mirage® encastrable
Appareil de remise en température à induction encastrable Mirage®

1,8 m

CE

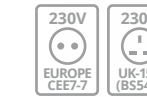

800 W
3,5 A
50/60Hz



| REF | L | Ø cm | H cm | Prof. cm | Volt. CA / AC | Plug Ench. | € / u | ☐ |
|---------|------|------|------|----------|---------------|------------|----------|---|
| 74702D | 6,6 | 30,3 | 31,3 | 17,6 | 230 | EU | 1.088,95 | 1 |
| 74703D | 6,6 | 30,3 | 31,3 | 17,6 | 230 | UK | 1.088,95 | 1 |
| 741102D | 10,4 | 35,3 | 31,3 | 17,6 | 230 | EU | 1.125,05 | 1 |
| 741103D | 10,4 | 35,3 | 31,3 | 17,6 | 230 | UK | 1.125,05 | 1 |

Drop-In / Encast.



47488 Lid with hinge
Tapa con visagra y orificio
Couvercle

CE



| REF | For / Para | Ø cm | € / u | ☐ |
|-------|---------------|------|-------|---|
| 47488 | 78184 / 88184 | 24,0 | 54,50 | 6 |
| 47490 | 78204 / 88204 | 28,7 | 64,25 | 6 |

12.4 Rethermalizers

Retermalizadores
Appareil de remise en température

Retro



Retro Rethermalizer unit heats products with water, like any bain marie. Heats food from a chilled state to a temperature in less than 90 minutes.

Ceramic base element ensures a fast start-up and consistent performance. Heavy duty exterior body ensures the unit remains cool to the touch while operating. Ladles sold separately.

El Retermalizador Retro calienta los productos con agua, como cualquier baño maría. Calienta la comida fría hasta una temperatura deseada en menos de 90 minutos.

El elemento de base cerámica garantiza un arranque rápido y un rendimiento uniforme. El cuerpo exterior no se calienta durante el uso del Retermalizador. Los cacillos se venden por separado.

L'unité de remise à la température Retro chauffe les produits avec de l'eau, comme tout bain marie. Chauffe les aliments d'un état réfrigéré à une température en moins de 90 minutes.

L'élément de base en céramique garantit un démarrage rapide et une performance homogène. L'extérieur ultra-robuste garantit que l'appareil reste frais au toucher tout en fonctionnant.

Rethermalizers 12.4

Retermalizadores
Appareil de remise en température

7217 Retro Stock Pot Kettle Rethermalizers
Retermalizadores Estilo Retro
Marmite de remise en température Rétro

CE
Retro

Natural
Naturel

Red
Rojo
Rouge

Blanc cassé
Blanco perla
Pearl white

Black
Negro
Noir



| REF | L | CA/AC Volt. | W | A | Plug Ench. | Hz | € / u | ☐ |
|---------|------|-------------|------|-----|------------|-------|--------|---|
| 7217810 | 6,6 | 230 | 1400 | 6,1 | EU | 50/60 | 923,75 | 1 |
| 7217910 | 6,6 | 230 | 1400 | 6,1 | UK | 50/60 | 923,75 | 1 |
| 7217850 | 6,6 | 230 | 1400 | 6,1 | EU | 50/60 | 923,75 | 1 |
| 7217950 | 6,6 | 230 | 1400 | 6,1 | UK | 50/60 | 923,75 | 1 |
| 7217855 | 6,6 | 230 | 1400 | 6,1 | EU | 50/60 | 923,75 | 1 |
| 7217955 | 6,6 | 230 | 1400 | 6,1 | UK | 50/60 | 923,75 | 1 |
| 7217860 | 6,6 | 230 | 1400 | 6,1 | EU | 50/60 | 923,75 | 1 |
| 7217960 | 6,6 | 230 | 1400 | 6,1 | UK | 50/60 | 923,75 | 1 |
| 7217310 | 10,4 | 230 | 1400 | 6,1 | EU | 50/60 | 940,95 | 1 |
| 7217410 | 10,4 | 230 | 1400 | 6,1 | UK | 50/60 | 940,95 | 1 |
| 7217350 | 10,4 | 230 | 1400 | 6,1 | EU | 50/60 | 940,95 | 1 |
| 7217450 | 10,4 | 230 | 1400 | 6,1 | UK | 50/60 | 940,95 | 1 |
| 7217355 | 10,4 | 230 | 1400 | 6,1 | EU | 50/60 | 940,95 | 1 |
| 7217455 | 10,4 | 230 | 1400 | 6,1 | UK | 50/60 | 940,95 | 1 |
| 7217360 | 10,4 | 230 | 1400 | 6,1 | EU | 50/60 | 940,95 | 1 |
| 7217460 | 10,4 | 230 | 1400 | 6,1 | UK | 50/60 | 940,95 | 1 |

4980 One-Piece Ergo Grip™ Ladles with Kool-Touch® Handles
Cacillos ErgoGrip™ de una sola pieza Kool-Touch®
Louches Ergo Grip™ monobloc avec manche Kool-Touch®



| REF | ml | Bowl / Bol / Ø cm | Total cm | *cm | € / u | ☐ |
|---------|-------|-------------------|----------|------|-------|---|
| 4980422 | 118,3 | 7,9 | 33,3 | 27,6 | 31,30 | 6 |
| 4980622 | 177,4 | 8,6 | 33,6 | 27,6 | 32,50 | 6 |

*Length from bowl bottom to bend in handle
*Largo desde el fondo del porcionador hasta el gancho del asa
*Longueur du fond du bol à la courbure dans le manche

One-piece construction. Stainless steel. Plastic-coated handles are heat resistant to 82° C.

Construcción de una sola pieza en acero inoxidable. Asas revestidas de plástico que resisten el calor hasta 82 °C.

Construction monobloc Inox. Manches plastifiés résistant à 82 °C.

46527 Lid with hinge
Tapa con visagra y orificio
Couvercle

CE

Retro



| REF | Ø cm | € / u | ☐ |
|-------|------|-------|---|
| 46527 | 24 | 73,25 | 6 |

Bain Maries
Baño maría
Bain-marie

Thermoset Fiber-Reinforced Resin Well
Selfinsulating. Maximum energy efficiency. Easy to clean.

Cuerpo de resina reforzada con fibra termofijada auto aislante. Máxima eficiencia energética. Fácil de limpiar.
Compartiment en résine thermodurcie renforcée Isotherme. Rendement énergétique maximal. Nettoyage facile.

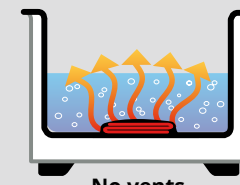

No vents
Sin ventilaciones
Sans ventilation

High efficiency
Alta eficiencia
Très écoénergétique

DIRECT CONTACT HEATING SYSTEM - The ultimate in performance and efficiency
The heating element is in direct contact with the water for the most efficient heat transfer possible. This is coupled with Vollrath's exclusive Thermoset fiber-reinforced resin well, which provides superior insulation for maximum energy efficiency. So much heat is saved that there is no need for vents.

SISTEMA DE CALENTAMIENTO DE CONTACTO DIRECTO - Lo último en rendimiento y eficiencia
La resistencia está en contacto directo con el agua, transfiriendo el calor de una forma más eficiente. Esto se combina con el exclusivo cuerpo de resina reforzada, permitiendo un máximo aislamiento y máxima eficiencia energética. No necesita ventilación.

SYSTÈME DE CHAUFFAGE PAR CONTACT DIRECT - Performance et efficacité maximales
L'élément chauffant est en contact direct avec l'eau afin de permettre un transfert de la chaleur le plus efficace possible. De plus, le compartiment exclusif de Vollrath en résine thermodurcie renforcée offre une insolation supérieure rendant possible un rendement écoénergétique maximum. La conservation de chaleur est telle qu'il est inutile d'utiliser des évents.

Upper rim designed to prevent drips and to drain off the moisture.
Borde superior diseñado para evitar goteos y drenar la humedad.
Bordure supérieure conçue pour éviter l'égouttement et drainer l'humidité.

Dome Heater. Uses up to 25% less energy. Non-stick surface prevents scale build-up for easy cleaning and longer operating life. Cast-in heating element for longer service life and greater energy transfer. Concentrates energy into the well – producing steam quickly.

Calentador con cúpula usa hasta un 25% menos de energía. La superficie antiadherente evita la acumulación de comida, facilitando la limpieza y prolongando la vida útil. Resistencia incrustada que alarga la vida útil y ayuda a difundir mejor el calor. Concentra la energía dentro del recipiente; produce vapor rápidamente.

Élément chauffant avec dôme qui utilise jusqu'à 25 % d'énergie en moins. La surface anti-adhésive empêche l'accumulation de dépôts calcaires pour faciliter le nettoyage et prolonger la durée de vie. Élément chauffant moulé pour prolonger la durée de service et augmenter le transfert d'énergie. Concentre l'énergie dans le compartiment; produit rapidement de la vapeur.

Capillary tube thermostat, provides energy only when it is required to reach the desired temperature.

Termostato de tubo capilar, suministra energía solamente cuando es necesario, para alcanzar la temperatura deseada.

Thermostat à tube capillaire, il fournit de l'énergie que lorsque c'est nécessaire pour atteindre la température souhaitée.

Non-skid Feet
Pies antideslizantes
Pieds antidérapants

Increased Water Capacity. Reduce labor costs. Improve food quality by maintaining maximum moist heat.

Mayor capacidad de agua reducen los costes de mano de obra. Mejoran la calidad de la comida manteniendo el máximo calor húmedo.

Capacité d'eau supérieure ayant pour conséquence une diminution des frais de main-d'oeuvre. Amélioration de la qualité des aliments grâce au maintien d'un maximal de chaleur humide.

Cooler Exterior Concentrates heat inside the well, not to the outside surface and rim.

Exterior más fresco concentra el calor dentro del receptáculo, no en la superficie exterior ni en el reborde.

Extérieur plus frais qui concentre la chaleur à l'intérieur du compartiment et non sur la surface extérieure ou sur le rebord.

Low positioning of electrical cord outlet adapts to the location of the power socket for safe installation. Allows the location to be controlled 360°. Standard cable length of 183 cm.

Cable eléctrico con salida inferior se adapta a la ubicación de la toma de corriente para una instalación segura. Permite controlar la ubicación en 360°. Largo estándar del cable de 183 cm.

Câble d'alimentation muni d'une sortie située à la base. S'adapte à la prise de courant pour une installation sûre. Permet le positionnement des commandes à 360 degrés. Câble d'une longueur standard de 183 cm.



EQUIPMENT
MAQUINARIA
EQUIPEMENT

EQUIPMENT
MAQUINARIA
EQUIPEMENT

12.4 Bain marie

Baños maría
Bain-marie



CAYENNE®

72522 Cayenne® Heat'N'Serve Rethermalizer
Olla Retermalizadora Cayenne® Heat'N'Serve
Ap. de remise en temp. Heat 'N Serve ronds Cayenne®

800 W
3,5 A
230 V



HS-11

| REF | cm (Ø x H) | L | V | W | Plug Ench. | € / u | 📦 |
|-------|-------------|------|-----|-----|------------|--------|---|
| 72522 | 32,0 x 24,5 | 10,4 | 230 | 800 | EU | 492,60 | 1 |

With inset, hinged cover
Con recipiente interior y tapa con visagra
Avec conteneur et couvercle

47488 / 47490 Lid with hinge
Tapa con visagra y orificio
Couvercle

CE



78204 Insert container
Recipiente interior
Conteneur pour appareil de remise en température Heat 'N Serve ronds Cayenne®

CE



| REF | For / Para | Ø cm | AL cm | L | € / u | 📦 |
|-------|------------|------|-------|------|-------|---|
| 78204 | 72522 | 28,7 | 20,8 | 10,4 | 76,50 | 6 |

*Not induction-ready insert
**Cubeta no apta para Inducción*
*Conteneur non Induction

| REF | For / Para | Ø cm | € / u | 📦 |
|-------|---------------|------|-------|---|
| 47488 | 78184 / 88184 | 24,0 | 54,50 | 6 |
| 47490 | 78204 / 88204 | 28,7 | 64,25 | 6 |

Bain marie 12.4

Baños maría
Bain-marie

72630 Rethermalizer Cayenne® Heat'N'Serve
72550 full size
Retermalizador Cayenne® Heat'N'Serve
1/1 Gastronorm
Appareils de remise en temp. Cayenne®
Heat'N Serve 1/1 Gastronorme

1.000 W
4,3 A
230 V
50/60 Hz



| REF | Well depth Profundidad cm | Plug Ench. | € / u | 📦 |
|-------|---------------------------|------------|--------|---|
| 72630 | 16,8 | EU | 433,25 | 1 |
| 72550 | 16,8 | UK | 433,25 | 1 |

Thermoset fiber reinforced well — self-insulating with maximum energy efficiency. Capillary Tube Thermostat Control

Recipiente de resina reforzada con fibra termofijada aislante. Máxima eficiencia energética. Control de termostato

Compartment en résine thermodurcie renforcée - isotherme pour un rendement énergétique maximal. Thermostat à tube capillaire



+30 °C
+90 °C



| REF | TIPO TYPE | V | W | Hz | € / u | 📦 |
|--------|-----------|-----|-------|-------|--------|---|
| P15020 | A | 230 | 1.200 | 50/60 | 345,05 | 1 |

Without bags
Sin cubetas
Sans bacs

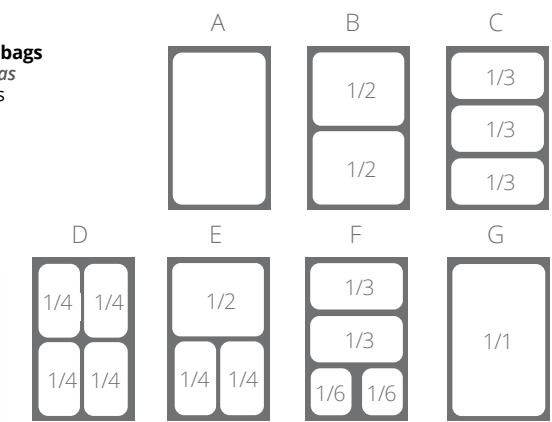

Max H 100 mm

12.4 Bain marie

Baños maría
Bain-marie

P688130 Vacuum sealer
Envasadora al vacío
Machine sous vide



| REF | V | W | Hz | Kg | € / u | ☐ |
|----------------|-----|-----|----|-----|--------|---|
| P688130 | 230 | 200 | 50 | 7,5 | 836,70 | 1 |

Compact vacuum sealer.

Food sealed under vacu-um can be preserved for much longer periods.

With the absence of oxygen, micro-organisms do not develop.

You can save time by cooking more than you need and keeping the excess in perfect condition for later use.

- 400mm sealing width
- Vacuum function for table pans
- Marinated / Liquids function
- Partial vacuum function
- 20 L/min vacuum pump
- Possibility of using as bag sealer only

Envasadora al vacío compacta.

Los tiempos de conservación de los alimentos al vacío son mucho mayores.

Los microorganismos no se desarrollan ante la ausencia de oxígeno.

Puede ahorrar tiempo al cocinar en exceso y poder conservarlo en perfectas condiciones para un posterior uso.

- 400mm de banda de soldadura
- Función de vacío para cubetas
- Función marinado / Líquidos
- Función vacío parcial
- 20 L/min bomba vacío
- Posibilidad de usar solo como selladora de bolsas

Machine sous vide compacte.

Les durées de conservation des aliments sous vide sont largement supérieures.

Les microorganismes ne se développent pas en raison de l'absence d'oxygène.

Vous pouvez gagner du temps en cuisinant en grande quantité que vous pouvez conserver dans de parfaites conditions pour une consommation ultérieure.

- Bande de soudure de 400 mm
- Fonction sous vide pour bacs
- Fonction marinade / Liquides
- Fonction sous vide partiel
- 20 L/min pompe à vide
- Peut s'utiliser comme scelleuse de sachets

P688133 Vacuum bags
P688134 Bolsas vacío
Sachets sous vide

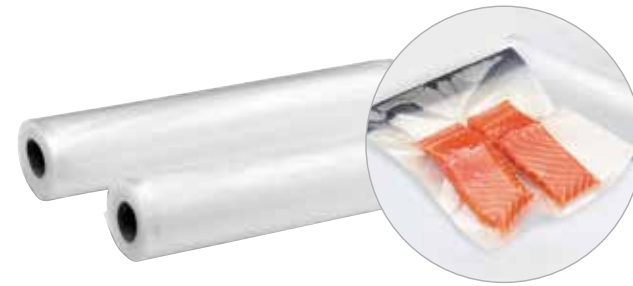

| REF | L m | W cm | € / u | ☐ |
|----------------|-----|------|-------|---|
| P688133 | 6 | 30 | 28,25 | 1 |
| P688134 | 6 | 40 | 37,25 | 1 |

P910008 Soup kettle
Olla eléctrica para buffet
Marmite buffet chaud



External aluminium body with epoxy coating.

Cuerpo de aluminio con baño epoxy.

Corps en aluminium laque epoxy.



| REF | cm | L | € / u | ☐ |
|----------------|-----------|------|--------|---|
| P910008 | 34,5 x 36 | 10,0 | 169,65 | 1 |

Thermostat to regulate the temperature. Resistance 400 W, 1,9 amperes, 230 V single phase, 50/60 Hz. St/Steel lid. Inside pool St/Steel, 10 lts. capacity.

Termostato regulador de temperatura. Resistencia 400 W, 1,9 amperios, 230 V monofase, 50/60 Hz. Tapa de acero inox. Cuba interior de acero inox. con capacidad para 10 litros.

Thermostat pour le réglage de la température. Résistance 400 W, 1,9 ampères, 230 V monophasée, 50/60 Hz. Couverture en acier inox. Cuve intérieure en acier inox. capacité 10 lts.

Heating lamps 12.4

Lámparas mantenedoras
Lampe chauffante

P15029 Heat shade with lamp
P15030 Lámpara mantenedora de comida caliente
Abat - jour pour lampe chauffante infra-rouge



| REF | Ø cm | V | W | Hz | € / u | ☐ |
|---------------|------|-----|-----|-------|--------|---|
| P15029 | 23 | 230 | 250 | 50/60 | 338,60 | 1 |
| P15030 | 23 | 230 | 250 | 50/60 | 371,05 | 1 |

Rise&fall cable
Cable extensible
Cable extensible

Delivered with red bulb
Se entrega con bombilla roja
Livraison avec ampoule rouge

Aluminium or copper. With on/off switch. It gives instant direct heat. Provides a penetrating heat without congealing surfaces, gravies, etc. Simple to install. Delivered with bulb (250 W max). Cable with rise and fall mechanism (max. 140 cm).

Aluminio o cobre. Con interruptor. Se pone en funcionamiento rápidamente y proporciona un calor penetrante sin solidificar la superficie de las salsas. Fácil de instalar. Se entrega con lámpara (250 W max). Versión con cable de mecanismo extensible (máx. 140 cm).

Aluminium ou cuivre. Avec interrupteur. Mise en service rapide. Chaleur pénétrante sans coaguler la surface des sauces, etc. Facile à installer. Livraison avec ampoule (250 W max). Avec cable extensible (max. 140 cm).

P688265 Heat shade
Lámpara mantenedora de comida caliente
Abat - jour pour lampe chauffante

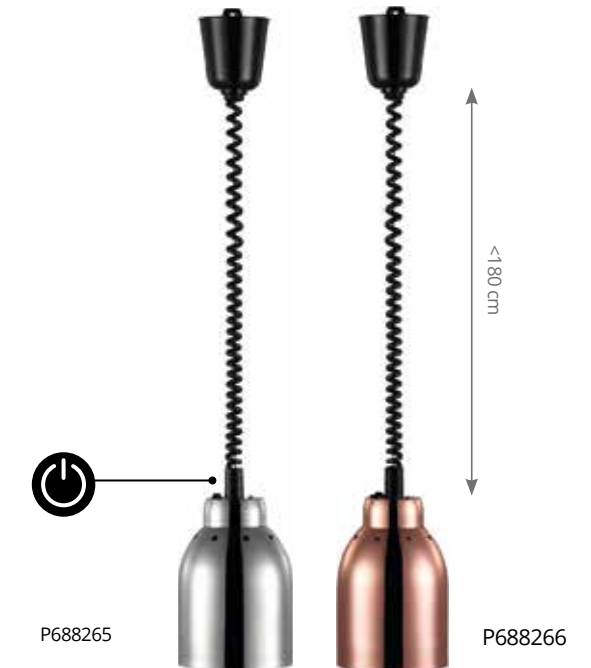

| REF | Ø cm | V | W | Hz | € / u | ☐ |
|--|------|-----|-----|-------|--------|---|
| P688265 St/Steel / Inox | 16 | 230 | 250 | 50/60 | 309,50 | 1 |
| P688266 Copper / Cobre / Cuivre | 16 | 230 | 250 | 50/60 | 309,50 | 1 |

Bulb not included.
Bombilla no incluida.
Ampoule non comprise.

Cable with rise and fall mechanism upto 180 cm.
Cable extensible hasta 180 cm.
Avec cable extensible jusqu'à 180 cm.

P688045 Heat shade
Lámpara mantenedora de comida caliente
Abat - jour pour lampe chauffante



Iron chrome plated with on/off switch. Delivered without bulb.
Cable with rise and fall mechanism upto 180 cm.

Acero acabado brillante con interruptor. Se entrega sin bombilla.
Cable extensible hasta 180 cm.

Acier fini brillant avec interrupteur.
Livraison sans ampoule. Avec cable extensible jusqu'à 180 cm.

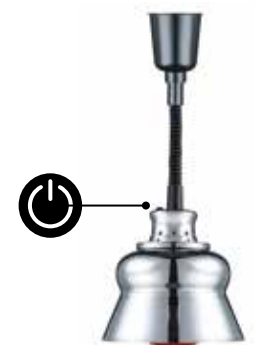

| REF | Ø cm | V | W | Hz | € / u | ☐ |
|----------------|------|-----|-----|-------|--------|---|
| P688045 | 23 | 230 | 250 | 50/60 | 217,80 | 4 |

12.4 Heating lamps

Lámparas mantenedoras
Lampe chauffante

P688250 Heat shade
Lámpara mantenedora de comida caliente
Abat - jour pour lampe chauffante



Bulb not included.
Bombilla no incluida.
Ampoule non comprise.

| REF | | Ø cm | V | W | Hz | €/u | |
|---------|-------------------------|------|-----|-----|-------|--------|---|
| P688250 | St/Steel / Inox | 24 | 230 | 250 | 50/60 | 555,10 | 1 |
| P688251 | Copper / Cobre / Cuivre | 24 | 230 | 250 | 50/60 | 555,10 | 1 |

P508015 Heat shade with table support
Lámpara mantenimiento comida caliente
con soporte mesa
Lampe chauffante avec support



| REF | W x D x H cm | V | W | Hz | €/u | |
|---------|--------------|-----|-----|-------|--------|---|
| P508015 | 22 x 22 x 65 | 230 | 250 | 50/60 | 811,50 | 1 |

Appliance adapted to heat and keep warm snacks and ready meals.
Structure is composed by an infrared lamp with a stainless steel base. Delivered with red bulb (250 W).

Lámpara adaptada para mantener caliente todos platos. Estructura compuesta de lámpara infrarrojos con base en acero inoxidable. Bombilla roja (250 W) incluida en el precio.

Lampe adaptée pour maintenir au chaud tous vos plats. Structure composée par lampe infrarouge avec base en inoxydable. Livrée avec ampoule rouge (250 W).

P688260 Heat shade with marble
Lámpara mantenedora de comida caliente con mármol
Abat - jour pour lampe chauffante avec marbre



Bulb not included.
Bombilla no incluida.
Ampoule non comprise.

| REF | | cm | V | W | Hz | €/u | |
|---------|-------------------------|---------|----|-----|-----|--------|-------|
| P688260 | St/Steel / Inox | 50 x 45 | 70 | 230 | 250 | 955,70 | 50/60 |
| P688261 | Copper / Cobre / Cuivre | 50 x 45 | 70 | 230 | 250 | 955,70 | 50/60 |

P15033 Bulb only
P15034 Bombilla
Ampoule seule



| REF | Color / Colour / Couleur | W | €/u | |
|---------|--------------------------|-----|-------|---|
| P15033 | Red / Rojo / Rouge | 175 | 36,10 | 1 |
| P710205 | Red / Rojo / Rouge | 250 | 52,15 | 1 |
| P15034 | White / Blanco / Blanc | 175 | 36,10 | 1 |
| P710206 | White / Blanco / Blanc | 250 | 52,15 | 1 |

Heating lamps 12.4

Lámparas mantenedoras
Lampe chauffante

Contoured carving station
Estación buffet trinchante
Station de découpage concave

Attractive Carving Station with lamps for additional heat while serving.
On/off lighted switch on base.

Atractiva estación trinchante (para carnes) con lámparas calentadoras. Interruptor iluminado de encendido/apagado en la base.

Station de découpage attrayante disposant de lampes pour plus de chaleur durant le service. Interrupteur lumineux de marche/arrêt sur la base.

2 x 175 W (Ref. P15033 / P15034)

Dual heat lamps.
Lámparas calentadoras dobles.
Deux lampes chauffantes

Spun aluminum shades for heat dissipation
Pantallas de aluminio para disipar el calor
Abat-jour en aluminium repoussé pour dissiper la chaleur

Clear tempered glass customer breath guard
Protección contra aliento con vidrio templado transparente
Pare-haleine en verre trempé transparent

Heavy-duty steel frame, chrome-plated
Marco de acero cromado altamente resistente
Cadre en acier chromé extra-robuste

Rubber feet provide stability and protect tabletop
Pies antideslizantes que ofrecen una mayor estabilidad
Les pieds en caoutchouc stabilisent et protègent la table

4667 Contoured Carving Station
Estación buffet trinchante
Station de découpage concave



Cord
Cable
Cordon
L: 1,8 m.



Stylish solid surface base & top
Base y parte superior elegantes con superficie lisa
Surface pleine esthétique (base et dessus)

Knife-friendly, dishwasher safe NSF Certified cutting board included
Incluye tabla de corte, apta para Certificación NSF
Planche à découper certifiée NSF incluse; apte pour le lave-vaisselle

Recessed base channels liquids into removable drip pan
La base empotrada canaliza los líquidos hacia una cubeta para goteo retirable
La base renforcée conduit les liquides dans un plateau ramasse-gouttes

| REF | W x D x H cm | CAVAC Volt. | Plug Ench. | Hz | €/u | |
|-------|------------------|-------------|------------|-------|----------|---|
| 46671 | 61 x 55,9 x 68,6 | 230 | EU | 50/60 | 2.601,40 | 1 |
| 46672 | 61 x 55,9 x 68,6 | 230 | UK | 50/60 | 2.601,40 | 1 |

Infrared bulb
Bombilla de infrarrojos
Ampoule infrarouge

2 Infrared bulb included
Incluye 2 bombillas de infrarrojos
Inclus 2 ampoules infrarouges

P15033

12.4 Warming equipment

Mantenedores de temperatura
Maintenance de température

P15073 Heating plate
P15074 Placa caliente
Plaque chauffante



18/10 St/Steel. Adjustable thermostat up to 75 °C. With on / off switch and indicator light.

Fabricada en acero inoxidable 18/10. Termostato regulable hasta 75 °C. Con interruptor central y piloto de control.

Habillage en inox 18/10. Thermostat réglable jusqu'à 75 °C. Interrupteur central et voyant de contrôle.

| REF | cm | V | W | Hz | € / u | ☐ |
|---------------|-----------|-----|-----|-------|--------|---|
| P15073 | 60 x 40,0 | 230 | 600 | 50/60 | 328,55 | 1 |
| P15074 | 53 x 32,5 | 230 | 600 | 50/60 | 301,70 | 1 |

P15096 Chocolate fountain
P15097 Fuente Fondue chocolate
Fontaine à chocolat



St/Steel body and parts. Temperature and control. Easy to clean. Adjustable foot for a stable standing.

Cuerpo y partes de acero inoxidable. Incorpora un regulador de temperatura. Muy fácil de desmontar y limpiar. Pie regulador para apoyo estable.

Corps et composants en acier inoxydable. Régulateur température. Très facile à nettoyer. Pied de régulation pour un appui stable.

| REF | ml | Levels / Niveles / Niveaux | V | Hz | Ø cm | H cm | W | € / u | ☐ |
|---------------|------|----------------------------|-----|----|------|------|-----|--------|---|
| P15096 | 700 | 3 | 230 | 50 | 21 | 38,0 | 250 | 107,45 | 1 |
| P15097 | 1200 | 4 | 230 | 50 | 23 | 45,0 | 250 | 135,15 | 1 |

46110 Universal electric chafer heater
Elemento eléctrico universal para chafing dish
Résistance électrique pour chafers



Sized to fit standard fuel opening. Dimensiones compatibles con el orificio para combustible estándar. Dimensions compatibles avec l'orifice pour combustible standard.

| REF | For Para | V | W | A | Hz | Plug Ench. | € / u | ☐ |
|--------------|----------|-----|---------|-----|-------|------------|--------|---|
| 46110 | EU | 230 | 120/230 | 1.0 | 50/60 | EU | 378,20 | 1 |
| 46115 | UK | 230 | 120/230 | 1.0 | 50/60 | UK | 378,20 | 1 |

P950000 Electric heating unit for chafing dish
Elemento eléctrico para chafing dish
Corps de chauffe pour chafing dish



| REF | W | Hz | € / u | ☐ |
|----------------|-----|-------|--------|---|
| P950000 | 240 | 50/60 | 214,60 | 1 |

P15010 Chocolate warmer
Baño maría chocolate
Chauffe-chocolat



IDEA! Special chocolate
Especial chocolate
Spécial chocolat

| REF | Units / Unidades / Unités | Lts | V | W | Hz | € / u | ☐ |
|---------------|---------------------------|------|-----|-----|-------|--------|---|
| P15010 | 1 | 3,50 | 230 | 250 | 50/60 | 597,90 | 1 |

Hot banquet trolleys 12.4

Armarios calientes
Armoires chaudes

New range of heated trolleys for banquets and other catering events, a range that enables you to take the kitchen to customer, guaranteeing maximum quality and the delivery of dishes at temperatures above 65 °C.

Nueva gama de carros calientes para banquetes y catering, que le permitirán acercarse a la cocina allí donde esté el cliente, asegurando la máxima calidad y la entrega de los platos por encima de los 65 °C.

Nouvelle gamme de chariots chauds pour banquets et service traiteur (catering), pour vous permettre de rapprocher la cuisine du lieu où se trouve le client, en garantissant la qualité maximale et la livraison des plats au-dessus de 65 °C.

EVEN CIRCULATION OF HOT AIR
UNIFORMIDAD DE CIRCULACIÓN DEL AIRE CALIENTE
UNIFORMITÉ CIRCULATION AIR CHAUD

The circulation of air is even and constant thanks to a unique system that makes it impossible for the containers to touch the cabinet base or sides.

Circulación uniforme y constante del aire gracias a un sistema único que imposibilita el contacto de las cubetas con el fondo o las paredes.

La circulation d'air chaud est uniforme et constant grâce à un système unique qui empêche que les bacs touchent le fond ou les parois.



Rockwool insulation
Aislamiento en lana de roca
Isolation en laine de roche

+LONG LASTING
Thermal insulation provided by rockwool preventing deformation through heat and lengthening the useful life of the cabinet.

+ENERGY SAVING
Thanks to the extraordinary thermal insulation system, the desired temperature is achieved more quickly and the heat is conserved for longer periods.

+HYGIENE
With the exclusive system of monoblock guides (without welds) cleanliness inside is grater, easier and faster.

+ DURADERO
Aislamiento térmico en lana de roca evitando la deformación con el calor y ampliando la vida útil del armario.

+ AHORRO ENERGÉTICO
Gracias al extraordinario sistema de aislamiento, se consigue el grado de temperatura deseado, con mayor rapidez y permite conservar el calor durante un periodo de tiempo más prolongado.

+ HIGIÉNICO
Con el sistema de guías monobloc (sin soldaduras) la limpieza interior es mayor, más fácil y rápida.

+DURABLE
Isolation thermique en laine de roca pour éviter la déformation par la chaleur et augmenter la vie utile de l'armoire.

+HYGIÉNIQUE
Grâce au système exclusif de glissières monobloc (sans soudures) le nettoyage intérieur est plus parfait, plus aisé et plus rapide.

+ÉCONOMIE D'ÉNERGIE
Grâce à l'extraordinaire système d'isolation thermique, la température souhaitée s'obtient plus rapidement et cela permet de conserver la chaleur pendant une plus longue période de temps.

12.4 Hot banquet trolleys

Armarios calientes
Armoires chaudes

2

CAPACITY / CAPACIDAD / CAPACITÉ

Monoblock guides (without welds) for St/Steel trays and Gastronorm containers 2/1 and 1/1.

Guías monobloc (sin soldaduras) para rejillas acero inoxidable y cubetas Gastronorm 2/1 y 1/1.

Glissières monobloc (sans soudures) pour grilles acier inoxydable et bacs Gastronorm 2/1 et 1/1.

EASY HANDLING / FÁCIL MANEJO / MANIPULATION AISÉE

Back side handles.
Rotating wheels 360°.
Front wheels with brakes

Asas posteriores.
Ruedas pivotantes & 360°.
Dos con freno

Poignées postérieures.
Roues pivotantes 360°.
Roues avant avec freins

3

HEAT BLOCK / BLOQUE CALÓRICO / BLOC CHAUFFANT

Extractable without the need of tools. Thermostat for regulation of temperature 0 °C to 90 °C. Provided with humidification container.

Extraíble sin necesidad de herramientas.
Termostato regulador temperatura 0 °C a 90 °C. Recipiente humidificador integrado.

Amovible sans besoin d'outils. Thermostat régulateur de température 0 °C - 90 °C. Bac humidification intégré.

P810

Ref. P81000



Ref. P81010



Ref. P81020

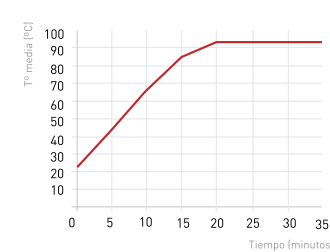
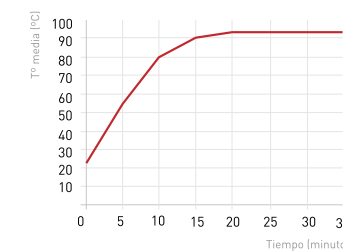
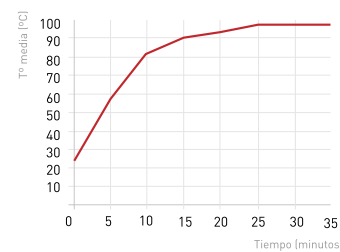

| REF | Rails Medidas Guías Dimensions Glissières | Capacity Capacidad Capacité | W | V | Hz | €/u | |
|--------|---|-----------------------------------|-------|-----|------|-------|------------|
| P81000 | GN 2/1 | 10 GN 2/1 - 20 GN 1/1 | 3.000 | 230 | V II | 50/60 | 4.111,90 1 |
| P81010 | GN 2/1 | 20 GN 2/1 - 40 GN 1/1 | 3.000 | 230 | V II | 50/60 | 5.329,25 1 |
| P81020 | GN 2/1 | 40 GN 2/1 - 80 GN 1/1 | 4.000 | 230 | V II | 50/60 | 7.649,25 1 |



Hot banquet trolleys 12.4

Armarios calientes
Armoires chaudes

P15027 / P15028 Hot cupboards

Calentador de platos
Chauffe - assiettes



+35 °C
+85 °C

Ref. P15027

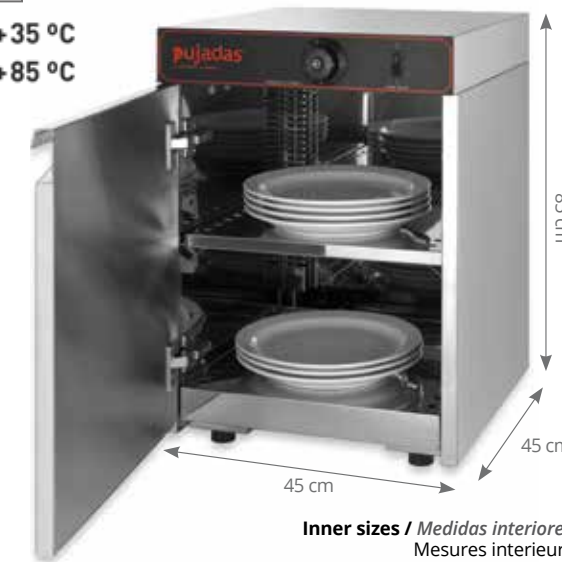

Ref. P15028



| REF | Capacity plates Capacidad platos Capacité assiettes | V | W | Hz | €/u | |
|--------|---|-----|-------|-------|----------|---|
| P15027 | 60 | 230 | 750 | 50/60 | 899,20 | 1 |
| P15028 | 120 | 230 | 1.250 | 50/60 | 1.603,40 | 1 |

Hot cupboards. St/Steel, wholly insulated. With thermostat and switch with indicator light, removable and adjustable shelves. Door with heavy duty hinges. Diameter max. plates 32 cm.

Calentadores de platos. Acero inoxidable, doble pared, completamente aislado térmicamente. Con termostato e interruptor con piloto de control. Estantes interiores regulables y extraíbles. Puertas con bisagras muy reforzadas. Diámetro máximo de los platos de 32 cm.

Chauffe-assiettes. Inox, double paroi, entièrement calorifugée, avec thermostat et interrupteur avec voyant de contrôle, étagères ajustables et amovibles. Porte avec charnières très résistantes. Diamètre max. assiettes 32 cm.

40862 Cubed-glass refrigerated display case

Vitrina de vidrio sobre encimera
Vitrine en verre sur plan de travail.



NEW!



| REF | W x D x H cm | V | A | Hz | Plug Ench. | |
|-------|-------------------|-----|------|----|------------|---|
| 40862 | 89,9 x 54 x 93,98 | 120 | 3,9 | 60 | USA | 1 |
| 40863 | 120 x 54 x 94 | 120 | 24,1 | 60 | USA | 1 |

- Digitally controlled thermostat on heated units for precise and consistent settings.
- Dual fans circulate air through unit to ensure even temperature control.
- Double-glaze front for added strength and insulation.

- Termostato con control digital par ajustes precisos y consistentes.
- Los ventiladores dobles permiten la circulación del aire por toda la unidad para garantizar un control uniforme de la temperatura.
- Frente de doble acristalamiento para mayor resistencia y aislamiento.

- Thermostat avec commande numérique pour des réglages précis et cohérents.
- Les doubles ventilateurs permettent la circulation de l'air dans toute l'unité pour assurer un contrôle uniforme de la température.
- Double vitrage pour plus de résistance et d'isolation.

Ice-cream and beverage solutions
Soluciones para la heladería
Solutions pour glaciers

Soft ice-cream & frozen yogurt

Helado soft y yogur helado
Glace à l'italienne



Stoelting offers commercial-grade gravity and pressure-fed Soft Serve Ice Cream, and Frozen Yogurt Machines in floor and countertop models. Whether you're looking for single flavor, twin twist, or double cylinder designs, we have the ideal equipment for your industry.

Stoelting ofrece la posibilidad de comercializar helados suaves a través de una alimentación por gravedad y presión. Ofrece máquinas de yogur helado de sobremesa y para ubicar en suelo. Dispone de diseños de un solo sabor, doble tirador o doble cilindro; en definitiva, equipos ideales para la industria y servicio de helados y postres fríos.

Stoelting offre la possibilità di commercializzare le gelaterie dolci attraverso un'alimentazione a gravità e pressione. Il propone delle macchine a yogurt glacé de table et à placer sur le sol. Il dispose de conceptions à une seule saveur, d'une poignée ou d'un double cylindre; en bref, un équipement idéal pour l'industrie et un service de crème glacée et de desserts froids.

| Series Serie Série | 111 | 131 | 231 | 411 | 431 | 144 | 421 |
|--|--|--|--------------------------------|--------------------------|--------------------------|--|--------------------------|
| Power supply Alimentación Alimentation | Gravity Gravedad Gravité | Gravity Gravedad Gravité | Gravity Gravedad Gravité | Pump Bomba Pompe | Pump Bomba Pompe | Gravity Gravedad Gravité | Pump Bomba Pompe |
| Flavours Sabores Parfums | 1 | 2+1 | 2+1 | 1 | 2+1 | Soft + Milshake | 2 |
| Type Tipo Type | Countertop Sobremesa De comptoir | Countertop Sobremesa De comptoir | Floor Suelo Au sol | Floor Suelo Au sol | Floor Suelo Au sol | Countertop Sobremesa De comptoir | Floor Suelo Au sol |
| CONES CAPACITY CAPACIDAD CONOS CAPACITÉ CONES | | | | | | | |
| Model Modelo Model | E | | | | | | |
| | 150-180 | 290-310 | - | - | - | - | - |
| Model Modelo Model | F / SF | | | | | | |
| | 275-300 | 400-420 | 400-420 | - | - | 220-240 | - |
| Model Modelo Model | O | | | | | | |
| | 380-420 | - | 780-820 | - | 675-700 | - | 675-700 |
| Model Modelo Model | U | | | | | | |
| | - | - | - | 640-660 | 1.350-1.400 | - | 1.350-1.400 |

*The production capacity may vary depending on the ambient temperature
 *La capacidad de producción puede variar en función de la temperatura ambiente utilizada
 *La capacité de production peut varier en fonction de la température ambiante au moment de l'utilisation

Shake & Smoothie freezers

Batidos & smoothies helados
Frappés & smoothies glacés



Stoelting's Shake & Smoothie Freezers feature a compact design with high-capacity output. Our equipment will handle high-demand rush hour requirements quietly and efficiently, while giving your profits a boost. Ideally suited for high volume commercial operations, such as fast food locations, drivings, theme parks, institutions, and recreations facilities. Perfect for thin or thick milshakes, frozen beverages, smoothies and frozen cocktails.

Los congeladores Shake & Smoothie de Stoelting presentan un diseño compacto con salida de alta capacidad. Nuestros equipos controlan de manera silenciosa y eficiente los picos de alta demanda, lo que permite ahorrar a la hora que identificar los momentos de más demanda. Ideal para operaciones comerciales de gran volumen en servicios, tales como cadenas de comida rápida, autocines, parques temáticos, instituciones e instalaciones recreativas. Perfecto para batidos finos o espesos, bebidas congeladas, batidos y cócteles congelados.

Les congélateurs Shake & Smoothie de Stoelting présentent un design compact avec une sortie de haute qualité. Nos équipes contrôlent silencieusement et efficacement les pics de demande, ce qui permet d'économiser en identifiant les moments les plus demandés. Idéal pour les opérations commerciales de grands volumes dans les services tels que les chaînes de restauration rapide, les cinémas automatiques, les parcs à thème, les institutions et les installations de loisirs. Parfait pour les smoothies fins ou épais, les boissons surgelées et les cocktails surgelés.

Frozen custard

Heladora custard
Glaces custard



Stoelting Frozen Custard Continuous Flow Freezer Machines have become the standard in the industry for quality and durability. With our Quick-Freeze Technology TM, the barrel freezes custard mix faster than any other machine. This minimizes the size of the ice crystals and ensures the smoothest, creamiest product.

Las máquinas congeladoras de flujo continuo se han convertido en el estándar en la industria de calidad y durabilidad. Con nuestra tecnología TM de congelación rápida, el barril congela la mezcla de crema pastelera de forma más rápida que cualquier otra máquina del mercado. Esto minimiza el tamaño de los cristales de hielo y asegura la consecución de un producto más suave y cremoso.

Les congélateurs à flux continu sont devenus la norme dans l'industrie en matière de qualité et de durabilité. Avec notre technologie de congélation rapide TM, le baril gèle le mélange de crème pâtissière plus rapidement que n'importe quelle autre machine sur le marché. Cela minimise la taille des cristaux de glace

| Series Serie Série | 112 | 122 | O212 | SU412 |
|---|--|--|--------------------------------|--------------------------------|
| | | | | |
| Power supply Alimentación Alimentation | Gravity Gravedad Gravité | Gravity Gravedad Gravité | Gravity Gravedad Gravité | Gravity Gravedad Gravité |
| Flavours Sabores Parfums | 1 | 2 | 1 | 1 |
| Type Tipo Type | Countertop Sobremesa De comptoir | Countertop Sobremesa De comptoir | Floor Suelo Au sol | Floor Suelo Au sol |
| LITRES/HOUR LITROS/HORA LITRES/HOUR | | | | |
| Model Modelo Model | E 45-68 | 90-136 | - | - |
| Model Modelo Model | F 68-91 | 136-182 | - | - |
| Model Modelo Model | SO - | - | 98 | - |
| Model Modelo Model | SU - | - | - | 114 |

| Series Serie Série | 101 | 202 | 303 |
|---|--|--------------------------------|--------------------------------|
| | | | |
| Power supply Alimentación Alimentation | Gravity Gravedad Gravité | Gravity Gravedad Gravité | Gravity Gravedad Gravité |
| Flavours Sabores Parfums | 1 | 2 | 3 |
| Type Tipo Type | Countertop Sobremesa De comptoir | Floor Suelo Au sol | Floor Suelo Au sol |
| LITRES/HOUR LITROS/HORA LITRES/HOUR | | | |
| Model Modelo Model | CF 19-23 | - | - |
| Model Modelo Model | M - | 26-38 | - |
| Model Modelo Model | CC - | 42-53 | 42-53 |

EQUIPMENT
MAQUINARIA
EQUIPEMENT

EQUIPMENT
MAQUINARIA
EQUIPEMENT

Batch equipment

Mantecadoras
Turbines à glace



Rugged, reliable batch freezers for Premium Ice Cream, Gelato, Sherbet, Sorbet, and Water Ices. Our Batch Ice Cream Machines are simple to operate, easy to maintain, and built to assure perfect frozen desserts every time.

Congeladores por lotes resistentes y confiables para helados, gelato, sorbete y helados de agua premium. Nuestras máquinas de helados por lotes son fáciles de operar, fáciles de mantener y construidas para asegurar postres congelados perfectos en todo momento.

Congélateurs laitiers robustes et fiables pour la crème glacée, le sorbet et la crème glacée premium. Les machines à crème glacée par lots sont faciles à utiliser, faciles à entretenir et construites pour assurer des desserts congelés parfaits à tout moment.

| Series Serie Série | VB1 | VB9 | VB25 |
|--|---|---|---------------------------------------|
| Power supply Alimentación Alimentation | Gravity Gravedad Gravité | Gravity Gravedad Gravité | Gravity Gravedad Gravité |
| Type Tipo Type | Countertop Sobremesa De comptoir | Countertop Sobremesa De comptoir | Floor Suelo Au sol |
| CAPACITY L/H | 9-10 | 9-10 | 20 |
| Work Cycle (min) Ciclo trabajo (min) Cycle de travail (min) | 14-18 | 14-18 | 12-15 |

Accesorios

Accesorios
Accessoires



Stoelting also offers accessories for our freezers, such as remote mix pumps to keep mix handling to a minimum, floor stands for converting counter top units to floor models, and mix-in blenders for marvelous mix-ins.

Stoelting también ofrece accesorios para nuestros congeladores, tales como bombas de mezcla remotas para mantener el manejo de mezclas al mínimo, soportes de suelo para convertir unidades de sobremesa en modelos de suelo y licuadoras mezclables para conseguir las mejores mezclas.

Stoelting offre également des accessoires pour nos congélateurs, tels que des pompes de mélange à distance pour maintenir la manipulation des mélanges au même niveau, des supports de sol pour convertir les unités de bureau en modèles de sol et des mixeurs pour obtenir de meilleurs résultats.

| Series Serie Série | Mixing blender | CW5 | CW2 |
|--|------------------------------|------------|------------|
| Power supply Control Alimentation | | | |
| Model 521030 | Foot Switch | - | - |
| Model 521035 | Mounted Speed Control | - | - |
| Revolution per minut RPM Type | 0-3000 | - | - |
| Capacity Capacidad (L) Capacité | - | 5 | 2 |

EQUIPMENT
MAQUINARIA
EQUIPEMENT

EQUIPMENT
MAQUINARIA
EQUIPEMENT

Cold & frozen Beverage dispensers





Bebidas frías y granizadoras
Boissons froides et granités

Stoelting manufactures a wide variety of commercial grade frozen beverage dispensing equipment. These compact and ultra high capacity units are perfect for a variety of high margin specialty drinks, smoothies, juices and frozen slush drinks including granitas, cappuccinos and frozen cocktails.

Stoelting fabrica una amplia variedad de equipos dispensadores de bebidas congeladas de grado comercial. Estas unidades compactas y de ultra alta capacidad son perfectas para una variedad de bebidas especiales de alto margen, batidos, zumos y bebidas congeladas, incluyendo granizados, capuchinos y cócteles congelados.

Stoelting fabrique une grande variété d'équipements de distribution de boissons congelées de qualité commerciale. Ces unités compactes et ultra-haute capacité sont parfaites pour une variété de boissons spéciales à marge élevée, de smoothies, de jus et de boissons surgelées, y compris les granités, les cappuccinos et les cocktails surgelés.

VCBF

| Series Serie Série | 118-37 | D118-37 | 128 | 168 |
|--|--|---|--|--|
|  |  |  |  | |
| Power supply Alimentación Alimentation | Gravity Gravedad Gravité | Gravity Gravedad Gravité | Gravity Gravedad Gravité | Gravity Gravedad Gravité |
| Flavours Sabores Parfums | 1 | 1 | 2 | 3 |
| Type Tipo Type | Countertop Sobremesa De comptoir | Countertop Sobremesa De comptoir | Countertop Sobremesa De comptoir | Countertop Sobremesa De comptoir |
| Capacity per bowl Capacidad por bol (L) Capacité par bol | 10 | 18,93 | 10 | 10 |
| BTU/Hr | 1100 | 8000 | 2550 | 3630 |

VCBA

| Series | 118-37 | A118 | 128 | 168 | 257 |
|--|--|--|--|--|--------------------------------|
|  |  |  |  |  | |
| Power supply Alimentación Alimentation | Gravity Gravedad Gravité | Gravity Gravedad Gravité | Gravity Gravedad Gravité | Gravity Gravedad Gravité | Gravity Gravedad Gravité |
| Flavours Sabores Parfums | 1 | 1 | 2 | 3 | 1 |
| Type Tipo Type | Countertop Sobremesa De comptoir | Countertop Sobremesa De comptoir | Countertop Sobremesa De comptoir | Countertop Sobremesa De comptoir | Floor Suelo Au sol |
| Capacity per bowl Capacidad por bol (L) Capacité par bol | 6 | 7,57 | 6 | 6 | 37,85 |
| BTU/Hr | 830 | 4500 | 1900 | 2550 | 2600 |

*Check with your salesteam for larger capacity machines.

*Consulta con tu comercial para máquinas de mayor capacidad

*Consultez votre commercial pour les machines de plus grande capacité

13 Melamine

Melamina y presentación
Melamine et présentation



-  **VOLCANO** 334
-  **STONEHENGE** 335
-  **SIENA** 336
-  **BIANCA** 337
-  **SAHARA** 338
-  **MOON** 339
-  **BUFFET DISPLAY** 340
-  **HIDRAULICA** 341
-  **WOOD** 342



NATURAL
343



ELEGANCE
355



COMPLETO TABLE
368



GREY SOUL
344



MEDITERRANEAN
356



VENUS
370



STYLISH
346



COLORS
357



WOOD BOARD
371



CLASSIC
346



COOL-LINE
358



STONE BOARD
372



WATER
347



ZEN
360



GN CLASSIC COLORS
374



DEEP BLUE
347



SHELL
361



GN CLASSIC BLACK
375



OCEAN
348



BLANCHE
362



GN SLIM
376



GOLDEN
349



FONTANA
362



GN CLASSIC WHITE
378



VERSATIL
350



OLA
363



STANDS
379



PASTRY
351



SHARING
364



MINI WHITE
380



TERRACOTA
352



CANON
366



MINI BLACK
381



STONE
354



LIFE
367



ASHTRAYS
383

It is highly recommended for table & buffet service for its properties.

Es un material muy utilizado en el servicio de mesa y presentación por sus propiedades.

Très utilisée dans le service de table et buffet par ses propriétés.



Melamine is a synthetic resin which becomes harden and Formed after heating

La melamina es una resina sintética que se endurece y toma forma después de un proceso de calentamiento

La mélamine est une résine Synthétique qui se durcit et prend-forme après un processus spécial de Chauffage

MAIN FEATURES
CARACTERÍSTICAS
PRINCIPALES CARACTÉRISTIQUES

SGS Food contact approved: certified by SGS
Contacto con alimentos: certificado por SGS
Contact avec aliments: certifié par SGS

+70°C
Withstands temperatures: -20°C & +70°C
Condiciones de trabajo: entre -20°C y +70°C
Températures entre: -20°C et +70°C

USES
USOS
USAGES

Not recommended: Microwave
No recomendada: Microondas
Non recommandée: Micro-ondes

Not recommended: Oven
No recomendada: Horno
Non recommandée: Four

Not recommended: Direct flame
No recomendada: Directo al fuego
Non recommandée: Direct au feu

Not recommended: Oil and chemical products
No recomendada: Aceite y productos químicos
Non recommandée: Huile ou produits chimiques

PROPERTIES
PROPIEDADES
PROPRIÉTÉS

Heat resistant
Resistente al calor
Résistante à la chaleur

Corrosion resistant
Resistente a la corrosión
Résistante à la corrosion

Non-toxic
No tóxico
Non-toxique

Non-odorous
Inodoro
Inodore

Light weight
Ligero
Légère

Free form deformation
Indeformable
Indéformable

Low heat conductivity
Poco conductor del calor
Baisse conductivité de la chaleur

MELAMINE
MELAMINA
MELAMINE

MELAMINE
MELAMINA
MELAMINE

13 Volcano



Me
Melamine

NEW!

P22377 Plate
Plato
Assiette



| REF | | Ø cm | H cm | €/ u | 📦 |
|--------|-------------|------|------|-------|----|
| P22377 | Light Blue | 23 | 2,0 | 10,75 | 12 |
| P22378 | Medium Blue | 26 | 2,2 | 14,05 | 12 |
| P22386 | Dark Blue | 23 | 2,0 | 10,75 | 12 |
| P22387 | Dark Blue | 26 | 2,2 | 14,05 | 12 |

P22379 Bowl
Bol
Bol



| REF | | Ø cm | H cm | €/ u | 📦 |
|--------|-------------|------|------|------|----|
| P22379 | Light Blue | 14 | 3,5 | 4,80 | 12 |
| P22380 | Medium Blue | 18 | 4,5 | 8,60 | 12 |
| P22388 | Dark Blue | 14 | 3,5 | 4,80 | 12 |
| P22389 | Dark Blue | 18 | 4,5 | 8,60 | 12 |

P22381 Deep plate
Plato hondo
Assiette creuse



| REF | | Ø cm | H cm | €/ u | 📦 |
|--------|------------|------|------|-------|---|
| P22381 | Light Blue | 25 | 5,7 | 16,90 | 6 |
| P22390 | Dark Blue | 25 | 5,7 | 16,90 | 6 |

P22382 Plate
Plato
Assiette



| REF | | Ø cm | H cm | €/ u | 📦 |
|--------|-------------|------|------|-------|---|
| P22382 | Light Blue | 15,2 | 2,7 | 5,30 | 6 |
| P22384 | Medium Blue | 21,5 | 3,1 | 10,45 | 6 |
| P22385 | Dark Blue | 24,0 | 3,4 | 13,05 | 4 |
| P22391 | Light Blue | 15,2 | 2,7 | 5,30 | 6 |
| P22393 | Medium Blue | 21,5 | 3,1 | 10,45 | 6 |
| P22394 | Dark Blue | 24,0 | 3,4 | 13,05 | 4 |

Stonehenge 13



Me
Melamine

NEW!

P22409 Rectangular tray
Bandeja rectangular
Plateau rectangulaire



| REF | W x D x H cm | €/ u | 📦 |
|--------|-------------------|-------|---|
| P22409 | 39,1 x 16,5 x 3,2 | 13,05 | 1 |

P22410 Oval plate
Plato ovalado
Assiette ovale



| REF | W x D x H cm | €/ u | 📦 |
|--------|-------------------|------|---|
| P22410 | 24,1 x 17,2 x 3,5 | 6,30 | 1 |

P22411 Display tray
Bandeja presentación
Plateau de présentation



| REF | W x D x H cm | €/ u | 📦 |
|--------|--------------|-------|---|
| P22411 | 54 x 27 x 2 | 33,70 | 1 |

P22412 Rectangular tray
Bandeja rectangular
Plateau rectangulaire



| REF | W x D x H cm | €/ u | 📦 |
|--------|----------------|-------|---|
| P22412 | 40 x 30 x 2,15 | 34,55 | 1 |

MELAMINE
MELAMINA
MELAMINE

MELAMINE
MELAMINA
MELAMINE



NEW!

P22413 Gray plate
Plato gris
Assiette grise



| REF | Ø cm | H cm | €/ u | |
|--------|------|------|------|---|
| P22413 | 22 | 1,5 | 6,20 | 1 |
| P22414 | 27 | 1,6 | 9,90 | 1 |

P22415 Blue plate
Plato azul
Assiette bleue



| REF | Ø cm | H cm | €/ u | |
|--------|------|------|------|---|
| P22415 | 22 | 1,5 | 6,20 | 1 |
| P22416 | 27 | 1,6 | 9,90 | 1 |

P22417 White plate
Plato blanco
Assiette blanche



| REF | Ø cm | H cm | €/ u | |
|--------|------|------|------|---|
| P22417 | 22 | 1,5 | 6,20 | 1 |
| P22418 | 27 | 1,6 | 9,90 | 1 |

See products on **P. 357**
Ver productos en / Voir produits en page



NEW!

P22368 Ripple ramekin
Ramekin ondulado
Ramequin ondulé



| REF | cm | H cm | ml | €/ u | |
|--------|-------|------|----|------|----|
| P22368 | Ø 6,2 | 3,5 | 60 | 1,25 | 48 |

P22369 Ripple ramekin
Ramekin ondulado
Ramequin ondulé



| REF | cm | H cm | ml | €/ u | |
|--------|-------|------|-----|------|----|
| P22369 | Ø 7,8 | 4,3 | 120 | 1,85 | 48 |

P22370 Ripple serving bowl
Bol ondulado
Bol ondulé



| REF | cm | H cm | €/ u | |
|--------|------|------|------|----|
| P22370 | Ø 14 | 9 | 5,15 | 12 |

P22371 Ripple serving bowl
Bol ondulado
Bol ondulé



| REF | cm | H cm | €/ u | |
|--------|------|------|------|----|
| P22371 | Ø 20 | 7 | 8,25 | 12 |

P22372 Ripple serving bowl
Bol ondulado
Bol ondulé



| REF | cm | H cm | €/ u | |
|--------|------|------|-------|---|
| P22372 | Ø 25 | 15 | 18,65 | 6 |

13 Sahara



Me
Melamine

NEW!

P22404 Oval plate
Plato ovalado
Assiette ovale



| REF | W x D x H cm | € / u | |
|--------|-----------------|-------|----|
| P22404 | 21,5 x 11 x 4,5 | 4,40 | 12 |

P22405 Oval bowl
Bol ovalado
Bol ovale



| REF | W x D x H cm | € / u | |
|--------|-----------------|-------|----|
| P22405 | 16,5 x 10 x 5,7 | 3,75 | 12 |
| P22406 | 20 x 15,5 x 10 | 12,70 | 12 |
| P22407 | 26 x 16 x 13,3 | 22,95 | 6 |

P22408 Oval bowl
Bol ovalado
Bol ovale



| REF | W x D x H cm | € / u | |
|--------|------------------|-------|---|
| P22408 | 32,5 x 26,5 x 18 | 47,35 | 3 |



Moon 13



Me
Melamine

NEW!

P22399 Round bowl
Bol redondo
Bol rond



| REF | Ø cm | H cm | € / u | |
|--------|------|------|-------|---|
| P22399 | 22,5 | 7 | 10,95 | 3 |
| P22400 | 29,0 | 10 | 17,70 | 3 |

P22401 Round bowl
Bol redondo
Bol rond



| REF | Ø cm | H cm | € / u | |
|--------|------|------|-------|---|
| P22401 | 34,5 | 7 | 20,10 | 3 |

P22402 Buffet display
Expositor buffet
Présentoir buffet



Compatible with
Compatible con P22399, P22400 y P22401
Compatible avec

| REF | Ø cm | H cm | € / u | |
|--------|------|------|-------|---|
| P22402 | 16,5 | 10 | 9,90 | 6 |
| P22403 | 16,5 | 18 | 14,80 | 6 |



Fitting system with the base
that provides stability

Sistema de encaje con la base
que aporta estabilidad

Système d'assemblage avec la
base qui assure la stabilité

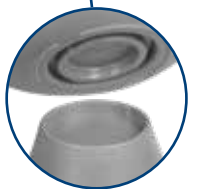

13 Buffet display

Expositor buffet
Présentoir buffet



NEW!

P22338 Buffet display
Expositor buffet
Présentoir buffet



Compatible with
Compatible con **P22361 P22362 y P22363**
Compatible avec

| REF | Ø cm | H cm | €/u | 📦 |
|--------|------|------|-------|---|
| P22366 | 16,5 | 10 | 10,30 | 6 |
| P22367 | 16,5 | 18 | 15,35 | 6 |

P22338 Display tray
Bandeja presentación
Plateau présentation



| REF | Ø cm | H cm | €/u | 📦 |
|--------|------|------|-------|---|
| P22361 | 22,7 | 1,5 | 8,00 | 1 |
| P22362 | 27,8 | 1,5 | 10,15 | 1 |
| P22363 | 32,7 | 1,5 | 14,30 | 1 |

The three pieces are sold separately
Las tres piezas se venden por separado
Les trois pièces sont vendues séparément

See products on **P. 395**
Ver productos en / Voir produits en page

Dome cover
Tapa campana
Couvercle cloche



Fitting system with the base that provides stability
Sistema de encaje con la base que aporta estabilidad
Système d'assemblage avec la base qui assure la stabilité

Hidraulica 13



NEW!

P22373 Display tray 1/1
Bandeja presentación 1/1
Plateau présentation 1/1



| REF | GN | W x D x H cm | €/u | 📦 |
|--------|-----|-----------------|-------|---|
| P22373 | 1/1 | 53 x 32,5 x 1,8 | 29,90 | 1 |

P22375 Display tray 1/3
Bandeja presentación 1/3
Plateau présentation 1/3



| REF | GN | W x D x H cm | €/u | 📦 |
|--------|-----|-------------------|-------|---|
| P22375 | 1/3 | 32,5 x 17,6 x 1,8 | 11,45 | 1 |

P22374 Display tray 1/2
Bandeja presentación 1/2
Plateau présentation 1/2



| REF | GN | W x D x H cm | €/u | 📦 |
|--------|-----|-------------------|-------|---|
| P22374 | 1/2 | 32,5 x 26,5 x 1,8 | 14,85 | 1 |

P22376 Display tray 2/4
Bandeja presentación 2/4
Plateau présentation 2/4



| REF | GN | W x D x H cm | €/u | 📦 |
|--------|-----|-----------------|-------|---|
| P22376 | 2/4 | 53 x 16,2 x 1,8 | 18,15 | 1 |

See products on **P. 397**
Ver productos en / Voir produits en page

Clear GN lids for presentation
Tapas GN transparentes presentación
Couvercles GN transparents de présentation



13 Wood



Me
Melamine

NEW!

P22424 Serving board
Tabla presentación
Table de présentation



| REF | W x D x H cm | €/u | |
|--------|-----------------|-------|---|
| P22424 | 37,5 x 14 x 1,5 | 12,80 | 1 |

P22426 Serving board
Tabla presentación
Table de présentation



| REF | W x D x H cm | €/u | |
|--------|-----------------|-------|---|
| P22426 | 28 x 15,5 x 1,5 | 12,70 | 1 |

P22127 Display plate
Soporte presentación
Présentoir



| REF | Ø cm | H cm | €/u | |
|--------|------|------|-------|---|
| P22127 | 23,0 | 1,5 | 11,90 | 1 |
| P22128 | 28,0 | 1,5 | 16,45 | 1 |
| P22129 | 32,5 | 1,5 | 21,40 | 1 |

P22425 Serving board
Tabla presentación
Table de présentation



| REF | W x D x H cm | €/u | |
|--------|---------------|-------|---|
| P22425 | 42 x 18 x 1,6 | 17,50 | 1 |

P22427 Serving board
Tabla presentación
Table de présentation



| REF | W x D x H cm | €/u | |
|--------|--------------------|-------|---|
| P22427 | 40,5 x 25,5 x 1,55 | 20,00 | 1 |

P2265 Oven oak peel
Pala horno roble
Pelle four chêne



| REF | cm | €/u | |
|--------|---------|-------|---|
| P22650 | Ø 30 | 34,30 | 6 |
| P22651 | 53 x 20 | 38,75 | 6 |
| P22652 | 61 x 20 | 46,00 | 6 |

Natural 13



Me
Melamine

P22324 Rectangular tray
Bandeja rectangular
Plateau rectangulaire



| REF | W x D x H cm | GN | €/u | |
|--------|-----------------|-----|-------|---|
| P22324 | 32,5 x 26,5 x 4 | 1/2 | 20,40 | 1 |
| P22328 | 32,5 x 26,5 x 4 | 1/2 | 20,40 | 1 |

P22322 Rectangular tray
Bandeja rectangular
Plateau rectangulaire



| REF | W x D x H cm | GN | €/u | |
|--------|---------------|-----|-------|---|
| P22322 | 53 x 16,5 x 4 | 2/4 | 21,80 | 1 |
| P22326 | 53 x 16,5 x 4 | 2/4 | 21,80 | 1 |

P22323 Rectangular tray
Bandeja rectangular
Plateau rectangulaire



| REF | W x D x H cm | GN | €/u | |
|--------|-----------------|-----|-------|---|
| P22323 | 32,5 x 17,6 x 4 | 1/3 | 15,85 | 1 |
| P22327 | 32,5 x 17,6 x 4 | 1/3 | 15,85 | 1 |

P22325 Leaf plate
Bandeja forma hoja
Plateau forme feuille



| REF | W x D x H cm | €/u | |
|--------|---------------|-------|---|
| P22325 | 37,5 x 15 x 2 | 13,45 | 1 |

MELAMINE
MELAMINA
MELAMINE

MELAMINE
MELAMINA
MELAMINE

13 Grey Soul



P22888 Square plate
Plato cuadrado
Assiette carrée



| REF | W x D x H cm | €/u | |
|--------|----------------|------|---|
| P22888 | 15 x 15 x 2,00 | 3,60 | 1 |
| P22889 | 18 x 18 x 2,00 | 5,00 | 1 |
| P22891 | 21 x 21 x 2,05 | 6,40 | 1 |

P22893 Rectangular tray
Bandeja rectangular
Plateau rectangulaire



| REF | W x D x H cm | €/u | |
|--------|-----------------|------|---|
| P22893 | 21,6 x 11 x 2,5 | 4,40 | 1 |
| P22894 | 29 x 11 x 2,5 | 6,05 | 1 |

P22896 Snacks or sauce tray
Bandeja snacks o salsas
Plateaux sauces



| REF | W x D x H cm | €/u | |
|--------|------------------|------|---|
| P22896 | 6,5 x 6,5 x 2,8 | 1,25 | 1 |
| P22897 | 11,5 x 6,5 x 2,8 | 2,20 | 1 |

P22892 Triangular plate
Plato triangular
Assiette triangulaire



| REF | W x D x H cm | €/u | |
|--------|---------------|------|---|
| P22892 | 20 x 20 x 6,8 | 6,20 | 1 |

P22898 Slanted round bowl
Bol redondo inclinado
Bol rond incliné



| REF | Ø cm | H cm | €/u | |
|--------|------|------|------|---|
| P22898 | 14,5 | 10,5 | 6,20 | 1 |
| P22899 | 17,5 | 12,2 | 8,80 | 1 |

P22308 Tapas dish
Plato tapas
Plat à tapas



| REF | Ø cm | H cm | €/u | |
|--------|------|------|------|---|
| P22308 | 14,0 | 2,5 | 2,80 | 1 |
| P22309 | 16,5 | 2,8 | 4,25 | 1 |

Grey Soul 13



P22306 Plate
Plato
Assiete



| REF | Ø cm | H cm | €/u | |
|--------|------|------|------|---|
| P22306 | 19,0 | 2,0 | 4,55 | 1 |
| P22307 | 21,5 | 2,5 | 7,05 | 1 |

P22303 Round bowl
Bol redondo
Bol rond



| REF | Ø cm | H cm | €/u | |
|--------|------|------|------|---|
| P22303 | 14,5 | 5,5 | 6,50 | 1 |
| P22304 | 24,0 | 6,0 | 9,70 | 1 |

P22895 Round bowl
Bol redondo
Bol rond



| REF | Ø cm | H cm | €/u | |
|--------|------|------|------|---|
| P22895 | 11 | 4,5 | 2,15 | 1 |

P22422 Rectangular plate
Plato rectangular
Assiette rectangulaire



| REF | W x D x H cm | €/u | |
|--------|----------------|------|---|
| P22422 | 32,7 x 9 x 5,8 | 3,60 | 1 |

P22305 Conical bowl
Bol cónico
Bol conique



| REF | Ø cm | H cm | €/u | |
|--------|------|------|------|---|
| P22305 | 12 | 6,5 | 3,85 | 1 |

P22301 Oval serving dish
Fuente oval
Plat ovale



| REF | W x D x H cm | €/u | |
|--------|-----------------|------|---|
| P22301 | 29,5 x 18 x 3,5 | 6,40 | 1 |
| P22302 | 34,5 x 22 x 4 | 9,80 | 1 |

P22423 Oval plate
Plato ovalado
Assiette ovale



| REF | W x D x H cm | €/u | |
|--------|--------------------|------|---|
| P22423 | 34,5 x 10,3 x 6 cm | 5,60 | 1 |

MELAMINE
MELAMINA
MELAMINE

MELAMINE
MELAMINA
MELAMINE

13 Stylish



P22333 Plate
Plato
Assiette



| REF | Ø cm | H cm | €/u | 📦 |
|--------|------|------|-------|---|
| P22333 | 20 | 2,0 | 8,05 | 1 |
| P22334 | 27 | 2,5 | 15,45 | 1 |
| P22335 | 31 | 3,0 | 19,40 | 1 |

Water 13



P22318 Plate
Plato
Assiette



| REF | Ø cm | H cm | €/u | 📦 |
|--------|------|------|-------|---|
| P22318 | 25,0 | 1,5 | 10,70 | 1 |
| P22319 | 27,5 | 1,5 | 12,05 | 1 |
| P22320 | 30,0 | 1,5 | 15,95 | 1 |

P22321 Deep dish
Plato hondo
Assiette creuse



| REF | W x D x H cm | €/u | 📦 |
|--------|-----------------|-------|---|
| P22321 | 23 x 17,5 x 6,5 | 13,90 | 1 |

Classic

P22329 Conical bowl
Bol cónico
Bol conique



| REF | Ø cm | H cm | €/u | 📦 |
|--------|------|------|-------|---|
| P22329 | 17 | 6 | 8,00 | 1 |
| P22330 | 22 | 8 | 15,35 | 1 |
| P22331 | 25 | 9 | 19,45 | 1 |

Deep Blue

P22332 Serving plate
Plato presentación
Assiette présentation



| REF | W x D x H cm | €/u | 📦 |
|--------|-----------------|-------|---|
| P22332 | 30 x 28,5 x 4,5 | 25,85 | 1 |

13 Ocean



P22316 Round bowl
Bol redondo
Bol rond



| REF | Ø cm | H cm | €/u | |
|--------|------|------|------|---|
| P22316 | 17 | 5 | 7,25 | 1 |

P22317 Deep dish
Plato hondo
Assiette creuse



| REF | Ø cm | H cm | €/u | |
|--------|------|------|-------|---|
| P22317 | 22,5 | 5 | 11,25 | 1 |

P22314 Plate
Plato
Assiette



| REF | Ø cm | H cm | €/u | |
|--------|------|------|-------|---|
| P22314 | 22 | 2 | 8,00 | 1 |
| P22315 | 27 | 2 | 12,25 | 1 |

P22313 Rectangular tray
Bandeja rectangular
Plateau rectangulaire



| REF | cm | H cm | GN | €/u | |
|--------|-------------|------|-----|-------|---|
| P22313 | 53,0 x 32,5 | 2 | 1/1 | 35,80 | 1 |
| P22312 | 32,5 x 26,5 | 2 | 1/2 | 18,40 | 1 |
| P22310 | 32,5 x 17,6 | 2 | 1/3 | 12,10 | 1 |
| P22311 | 53,0 x 16,5 | 2 | 2/4 | 17,20 | 1 |

Golden 13



P22344 Plate
Plato
Assiete



| REF | Ø cm | H cm | €/u | |
|--------|------|------|-------|---|
| P22344 | 23,0 | 3,0 | 11,10 | 1 |
| P22345 | 27,5 | 3,5 | 17,25 | 1 |
| P22346 | 32,0 | 4,0 | 21,45 | 1 |

P22347 Serving plate
Plato presentación
Assiette présentation



| REF | W x D x H cm | €/u | |
|--------|-----------------|-------|---|
| P22347 | 29 x 26,5 x 1,5 | 12,65 | 1 |

P22886 Serving plate
Plato presentación
Assiette présentation



| REF | W x D x H cm | €/u | |
|--------|-----------------|-------|---|
| P22886 | 25,9 x 16,7 x 2 | 11,00 | 1 |

P22348 Oval serving dish
Fuente oval
Plat ovale



| REF | W x D x H cm | €/u | |
|--------|-----------------|-------|---|
| P22348 | 30,5 x 11 x 3 | 7,70 | 1 |
| P22884 | 35,5 x 12,8 x 3 | 9,35 | 1 |
| P22885 | 40,6 x 14,7 x 3 | 11,80 | 1 |

P22887 Plate 2 compartments
Plato 2 compartimentos
Assiette 2 compartiments



| REF | W x D x H cm | €/u | |
|--------|-----------------|-------|---|
| P22887 | 28,4 x 11 x 2,5 | 10,20 | 1 |

13 Versatil



P22339 Tapas dish
Plato tapas
Plat à tapas



| REF | W x D x H cm | €/u | |
|--------|---------------|------|---|
| P22339 | 13 x 15,5 x 4 | 4,65 | 1 |
| P22341 | 15 x 15 x 2,5 | 4,50 | 1 |

P22336 Deep dish
Plato hondo
Assiette creuse



| REF | Ø cm | H cm | €/u | |
|--------|------|------|-------|---|
| P22336 | 25,5 | 5,5 | 16,45 | 1 |

P22342 Rectangular tray
Bandeja rectangular
Plateau rectangulaire



P22340 Plate
Plato
Assiete



| REF | Ø cm | H cm | €/u | |
|--------|------|------|------|---|
| P22340 | 19,5 | 3 | 9,10 | 1 |

P22337 Oval serving dish
Fuente oval
Plat ovale



| REF | W x D x H cm | €/u | |
|--------|---------------|-------|---|
| P22337 | 23 x 16,5 x 3 | 9,30 | 1 |
| P22338 | 28 x 20 x 3 | 13,45 | 1 |

| REF | W x D x H cm | €/u | |
|--------|---------------|-------|---|
| P22342 | 31,5 x 23 x 3 | 20,40 | 1 |
| P22343 | 33,5 x 13 x 3 | 19,10 | 1 |

Me
Melamine

Pastry 13



P23990 Display tray
Bandeja presentación
Plateau présentation



P22775 Confectionery tray
Bandeja repostería
Plateau à pâtisserie



| REF | H cm | cm | H cm | €/u | |
|--------|------|------|------|-------|---|
| P22775 | 36,5 | 29,5 | 2 | 19,15 | 1 |
| P22778 | 36,5 | 29,5 | 2 | 19,15 | 1 |
| P22779 | 36,5 | 29,5 | 2 | 19,15 | 1 |

See products on **P. 397**
Ver productos en / Voir produits en page

Clear GN lids for presentation
Tapas GN transparentes presentación
Couvercles GN transparentes de présentation



13 Terracota



Terracota 13

P22740 Tapas dish
Plato tapas
Plat à tapas



| REF | Ø cm | H cm | €/u | |
|--------|------|------|-------|---|
| P22740 | 19,0 | 4,0 | 7,75 | 1 |
| P22741 | 24,0 | 5,1 | 11,95 | 1 |
| P22742 | 28,5 | 6,5 | 17,25 | 1 |
| P22743 | 35,5 | 6,5 | 23,15 | 1 |

P22744 Tapas dish
Plato tapas
Plat à tapas



| REF | Ø cm | H cm | €/u | |
|--------|------|------|------|---|
| P22744 | 10,5 | 3,5 | 3,70 | 1 |
| P22745 | 13,0 | 4,0 | 5,45 | 1 |
| P22746 | 15,5 | 4,5 | 7,75 | 1 |

P22700 Conical bowl
Bol cónico
Bol conique



| REF | Ø cm | H cm | €/u | |
|--------|------|------|-------|---|
| P22700 | 9,5 | 5,5 | 3,35 | 1 |
| P22701 | 11,5 | 5,5 | 4,20 | 1 |
| P22702 | 15,0 | 6,0 | 5,60 | 1 |
| P22703 | 18,0 | 9,5 | 8,50 | 1 |
| P22704 | 20,5 | 7,5 | 11,95 | 1 |
| P22705 | 23,0 | 8,0 | 14,85 | 1 |

P22710 Tapas dish
Plato tapas
Plat à tapas



| REF | Ø cm | H cm | €/u | |
|--------|------|------|------|---|
| P22710 | 10,5 | 3,5 | 3,70 | 1 |
| P22711 | 15,5 | 4,5 | 7,75 | 1 |
| P22712 | 18,0 | 4,5 | 9,00 | 1 |

P22750 Square tray
Bandeja cuadrada
Plateau carré



| REF | W x D x H cm | €/u | |
|--------|-------------------|-------|---|
| P22750 | 20,5 x 20,5 x 3 | 9,45 | 1 |
| P22751 | 25,5 x 25,5 x 3,5 | 15,30 | 1 |
| P22752 | 29 x 29 x 4 | 20,80 | 1 |

P22755 Rectangular tray
Bandeja rectangular
Plateau rectangulaire



| REF | W x D x H cm | €/u | |
|--------|--------------|-------|---|
| P22755 | 21 x 11 x 2 | 6,80 | 1 |
| P22756 | 26 x 13 x 3 | 10,00 | 1 |

P22760 Snacks or sauce tray
Bandeja snacks o salsas
Plateaux sauces



| REF | W x D x H cm | €/u | |
|--------|----------------|------|---|
| P22760 | 29,5 x 9,5 x 3 | 7,15 | 1 |

P22770 Serving plate
Plato presentación
Assiette présentation



| REF | W x D x H cm | €/u | |
|--------|-----------------|-------|---|
| P22770 | 22 x 18,5 x 1 | 5,15 | 1 |
| P22772 | 44,5 x 35 x 1,5 | 25,65 | 1 |

P22999 Black melamine wok
Wok negro de melamina
Wok noir en mélamine



| REF | W x D x H cm | €/u | |
|--------|--------------|-------|---|
| P22999 | 38 x 30 x 10 | 23,05 | 1 |

P22419 6 compartment tray
Bandeja 6 compartimentos
Plateau 6 compartiments



| REF | W x D x H cm | €/u | |
|--------|--------------|------|---|
| P22419 | 41 x 7 x 3,8 | 5,55 | 1 |

13 Stone



P22824 Round bowl
Bol redondo
Bol rond



| REF | Ø cm | H cm | €/u | |
|--------|------|------|------|---|
| P22824 | 11,5 | 4,0 | 2,60 | 1 |
| P22823 | 14,0 | 5,5 | 3,50 | 1 |
| P22825 | 19,0 | 6,5 | 7,05 | 1 |

P22815 Plate
Plato
Assiette



| REF | Ø cm | H cm | €/u | |
|--------|------|------|-------|---|
| P22815 | 22,5 | 3,0 | 6,60 | 1 |
| P22816 | 25,0 | 3,0 | 8,45 | 1 |
| P22817 | 27,5 | 3,5 | 12,35 | 1 |

P22850 Curved board
Tabla presentación curvada
Planche incurvée présentaion



| REF | W x D x H cm | €/u | |
|--------|-----------------|-------|---|
| P22850 | 20 x 14 x 2 | 4,90 | 1 |
| P22851 | 25 x 17,5 x 2,5 | 10,60 | 1 |
| P22852 | 30 x 20 x 2,5 | 12,70 | 1 |

P22800 Serving board
Tabla presentación
Planche de service



| REF | W x D x H cm | €/u | |
|--------|---------------|-------|---|
| P22800 | 21 x 12 x 2,5 | 7,45 | 1 |
| P22801 | 24 x 14 x 2,5 | 9,30 | 1 |
| P22802 | 27 x 18 x 2,5 | 14,70 | 1 |
| P22803 | 33 x 19 x 2,5 | 18,65 | 1 |

Elegance 13



P22782 Oblong display tray
Bandeja exhibición rectangular
Plateau rectangulaire



| REF | W x D x H cm | €/u | |
|--------|--------------|-------|---|
| P22782 | 35 x 25 x 4 | 27,60 | 1 |

P22780 Oblong plate
Fuente rectangular
Plateau rectangulaire



| REF | W x D x H cm | €/u | |
|--------|--------------|-------|---|
| P22780 | 25 x 16 x 3 | 12,70 | 1 |

P22781 Rectangular tray
Bandeja rectangular
Plateau rectangulaire



| REF | W x D x H cm | €/u | |
|--------|---------------|-------|---|
| P22781 | 32 x 12 x 2,5 | 10,95 | 1 |

P22783 Oval serving dish
Fuente oval
Plat ovale



| REF | W x D x H cm | €/u | |
|--------|---------------|-------|---|
| P22783 | 35 x 15 x 2,5 | 14,50 | 1 |

P22784 Leaf plate
Bandeja forma hoja
Plateau forme feuille



| REF | W x D x H cm | €/u | |
|--------|-----------------|-------|---|
| P22784 | 34,5 x 13,5 x 3 | 11,75 | 1 |

13 Mediterranean

Me
Melamine



P22725 Dish
Plato
Assiette



| REF | Ø cm | H cm | € / u | |
|--------|------|------|-------|---|
| P22720 | 22,0 | 2,0 | 4,95 | 1 |
| P22725 | 27,0 | 2,0 | 8,50 | 1 |

P22726 Deep dish
Plato hondo
Assiette creuse



| REF | Ø cm | H cm | € / u | |
|--------|------|------|-------|---|
| P22726 | 20,0 | 3,5 | 4,75 | 1 |

P22727 Oblong plate
Fuente rectangular
Plateau rectangulaire



| REF | W x D x H cm | H cm | € / u | |
|--------|-----------------|------|-------|---|
| P22727 | 20 x 14,5 x 4,5 | 4,5 | 3,10 | 1 |
| P22728 | 23 x 17,5 x 4,5 | 4,5 | 4,60 | 1 |
| P22729 | 27 x 20 x 4,5 | 4,5 | 7,15 | 1 |

P22758 Round bowl
Bol redondo
Bol rond



| REF | Ø cm | H cm | € / u | |
|--------|------|------|-------|---|
| P22758 | 12,5 | 7,0 | 2,90 | 1 |

P22759 Glass
Vaso
Verre



| REF | Ø cm | H cm | € / u | |
|--------|------|------|-------|---|
| P22759 | 8,0 | 9,5 | 2,65 | 1 |

Colors 13

Me
Melamine



P22830 Serving plate
Plato presentación
Assiette présentation



Yellow / Amarillo / Jaune

| REF | Ø cm | H cm | € / u | |
|--------|------|------|-------|---|
| P22830 | 22 | 2,5 | 4,50 | 1 |
| P22833 | 28 | 2,5 | 6,75 | 1 |

P22834 Serving plate
Plato presentación
Assiette présentation



Grey / Gris / Gris

| REF | Ø cm | H cm | € / u | |
|--------|------|------|-------|---|
| P22834 | 22 | 2,5 | 4,50 | 1 |
| P22835 | 28 | 2,5 | 6,75 | 1 |

P22838 Serving plate
Plato presentación
Assiette présentation



Orange / Naranja

| REF | Ø cm | H cm | € / u | |
|--------|------|------|-------|---|
| P22838 | 22 | 2,5 | 4,50 | 1 |
| P22839 | 28 | 2,5 | 6,75 | 1 |

P22844 Serving plate
Plato presentación
Assiette présentation



Red / Rojo / Rouge

| REF | Ø cm | H cm | € / u | |
|--------|------|------|-------|---|
| P22844 | 22 | 2,5 | 4,50 | 1 |
| P22845 | 28 | 2,5 | 6,75 | 1 |

13 Cool-line



Me
Melamine

P22884 Glass

Vaso
Verre



| REF | Ø cm | H cm | ml | €/ u | 📦 |
|----------|------|------|----|------|---|
| P22884A | 8,5 | 9 | 30 | 2,80 | 1 |
| P22884N | 8,5 | 9 | 30 | 2,80 | 1 |
| P22884G | 8,5 | 9 | 30 | 2,80 | 1 |
| P22884R | 8,5 | 9 | 30 | 2,80 | 1 |
| P22884B | 8,5 | 9 | 30 | 2,60 | 1 |
| P22884NE | 8,5 | 9 | 30 | 2,80 | 1 |

P23800 Mini round casserole with lid

Mini cacerola con tapa
Mini cocotte avec couvercle



| REF | Ø cm | H cm | €/ u | 📦 |
|---------|------|------|-------|---|
| P23800A | 10 | 6,5 | 11,65 | 1 |
| P23800N | 10 | 6,5 | 11,65 | 1 |
| P23800G | 10 | 6,5 | 11,65 | 1 |
| P23800R | 10 | 6,5 | 11,65 | 1 |

P22223 Wood base for 3 mini casseroles

Base de madera para 3 mini cacerolas
Base en bois pour 3 mini cocottes

Wo
Wood



| REF | W x D x H cm | €/ u | 📦 |
|--------|-----------------|-------|---|
| P22223 | 43 x 15,5 x 5,1 | 24,30 | 1 |



IDEA! Suitable for P23800, P23800A, P23800N, P23800G, P23800R.
Compatible con P23800, P23800A, P23800N, P23800G, P23800R.
Adaptable pour P23800, P23800A, P23800N, P23800G, P23800R.

Cool-line 13



Me
Melamine

P22370 Two tones deep squared bowl

Bol cuadrado hondo dos colores
Bol carré deux couleurs



| REF | W x D x H cm | €/ u | 📦 |
|---------|--------------|------|---|
| P22370A | 9 x 9 x 5,5 | 4,65 | 1 |
| P22370N | 9 x 9 x 5,5 | 4,65 | 1 |
| P22370G | 9 x 9 x 5,5 | 4,65 | 1 |
| P22370R | 9 x 9 x 5,5 | 4,65 | 1 |

P22371 Two tones deep squared bowl

Bol cuadrado hondo dos colores
Bol carré deux couleurs



| REF | W x D x H cm | €/ u | 📦 |
|---------|---------------|-------|---|
| P22371A | 18 x 18 x 8,5 | 14,25 | 1 |
| P22371N | 18 x 18 x 8,5 | 14,25 | 1 |
| P22371G | 18 x 18 x 8,5 | 14,25 | 1 |
| P22371R | 18 x 18 x 8,5 | 14,25 | 1 |

P590007 Lid

Tapa
Couvercle

PP
Polypropylene



Price / Precio / Prix : Pack 6 u

Non-hermetic closure
Cierre no hermético
Fermeture non hermétique

Minimum purchase: pack of 6 units
Compra mínima: pack 6u
Achat minimum : pack de 6 unités

| REF | W x D x H cm | €/ u | 📦 |
|---------|---------------|-------|---|
| P590007 | 18 x 18 x 2,5 | 14,45 | 6 |



IDEA! Suitable for 18 x 18 deep squared bowl.
Compatible con bol cuadrado hondo 18x18.
Adaptable pour bol carré 18 x 18.

13 Zen



Me
Melamine

P2290 Dish
Plato
Assiette



| REF | Ø cm | H cm | €/u | 📦 |
|--------|------|------|-------|----|
| P22901 | 19,5 | 2,8 | 8,20 | 12 |
| P22902 | 28,0 | 2,9 | 17,65 | 12 |

P2291 Bowl
Bol
Bol



| REF | Ø cm | H cm | €/u | 📦 |
|--------|------|------|------|----|
| P22911 | 10,1 | 4,0 | 4,25 | 12 |
| P22912 | 11,5 | 5,8 | 5,10 | 12 |

P2294 Rectangular Tray
Bandeja rectangular
Plateau rectangulaire



| REF | W x D x H cm | €/u | 📦 |
|--------|-------------------|-------|----|
| P22940 | 23,4 x 14,7 x 2,5 | 13,70 | 12 |

P2297 Noodles bowl
Bol para noodels
Bol pour nouilles



| REF | Ø cm | H cm | €/u | 📦 |
|--------|------|------|-------|----|
| P22971 | 17,3 | 7,6 | 12,45 | 12 |
| P22972 | 25,0 | 8,7 | 22,00 | 6 |

P2296 Sauce bowl
Bol para salsas
Bol pour sauces



IDEAL! Suitable for P22950.
Compatible con P22950.
Adaptable pour P22950.



| REF | Ø cm | H cm | €/u | 📦 |
|--------|------|------|------|----|
| P22960 | 11,5 | 5,5 | 4,60 | 20 |

P2295 Dish for bowl
Plato para bol
Assiette pour bol



IDEAL! Suitable for P22960.
Compatible con P22960.
Adaptable pour P22960.



| REF | W x D x H cm | €/u | 📦 |
|--------|-------------------|------|----|
| P22950 | 15,9 x 12,7 x 2,3 | 5,25 | 12 |

Shell 13



Me
Melamine

P22354 Plate
Fuente
Plateau



P22354

| REF | W x D x H cm | €/u | 📦 |
|--------|-----------------|-------|---|
| P22354 | 25 x 23,5 x 3 | 6,80 | 1 |
| P22355 | 40 x 38,5 x 6,5 | 18,50 | 1 |

P22356 Plate
Fuente
Plateau



P22355

| REF | W x D x H cm | €/u | 📦 |
|--------|-----------------|-------|---|
| P22356 | 35 x 26,5 x 3,5 | 7,80 | 1 |
| P22357 | 46 x 35 x 5 | 13,90 | 1 |

P22358 Plate
Fuente
Plateau



| REF | W x D x H cm | €/u | 📦 |
|--------|--------------|-------|---|
| P22358 | 28,5 x 27,5 | 13,40 | 1 |

13 Blanche



Ola 13



P22420 Rectangular tray
Bandeja rectangular
Plateau rectangulaire



| REF | W x D x H cm | €/u | |
|--------|-----------------|------|---|
| P22420 | 26,5 x 11 x 2,3 | 5,50 | 1 |
| P22421 | 37 x 11 x 2,5 | 8,45 | 1 |

P22349 Rectangular tray
Bandeja rectangular
Plateau rectangulaire



| REF | W x D x H cm | €/u | |
|--------|---------------|-------|---|
| P22349 | 25 x 18 x 3,5 | 11,45 | 1 |
| P22350 | 30 x 21,5 x 4 | 17,30 | 1 |
| P22351 | 35 x 25 x 4 | 24,60 | 1 |

P2297 Round bowl
Bol redondo
Bol rond



P. 393



| REF | Ø cm | H cm | €/u | |
|--------|------|------|-------|---|
| P22973 | 25 | 11 | 21,45 | 1 |
| P22974 | 28 | 12 | 24,15 | 1 |
| P22975 | 35 | 15 | 41,95 | 1 |

P22170 Leaf plate
Bandeja forma hoja
Plateau forme feuille



| REF | W x D x H cm | €/u | |
|--------|---------------|-------|---|
| P22170 | 50,5 x 24 x 7 | 29,60 | 3 |

P22352 Round bowl
Bol redondo
Bol rond



| REF | Ø cm | H cm | €/u | |
|--------|------|------|-------|---|
| P22352 | 17,5 | 5,5 | 6,60 | 1 |
| P22353 | 24,0 | 8,0 | 12,85 | 1 |

Fontana

P22359 Slanted round bowl
Bol redondo inclinado
Bol rond incliné



| REF | W x D x H cm | €/u | |
|--------|------------------|-------|---|
| P22359 | 35,5 x 32 x 14,5 | 19,70 | 1 |
| P22360 | 46 x 40,5 x 18,5 | 36,95 | 1 |

P22169 Oval bowl
Bol oval
Bol ovale



| REF | W x D x H cm | €/u | |
|--------|----------------|-------|---|
| P22169 | 29 x 16,5 x 15 | 26,90 | 6 |

P2217 Spin round bowl
Bol torneado
Bol tourné



| REF | Ø cm | H cm | €/u | |
|--------|------|------|-------|---|
| P22171 | 20,5 | 9,5 | 12,70 | 3 |
| P22172 | 24,5 | 10,5 | 19,20 | 3 |
| P22173 | 28,0 | 12,0 | 29,60 | 3 |

13 Sharing



Me
Melamine

P22037 High oblong plate
Fuente rectangular alta
Plateau rectangular haut



| REF | W x D x H cm | € / u | |
|--------|--------------|-------|---|
| P22037 | 50 x 20 x 5 | 35,10 | 3 |

P22038 High oblong plate
Fuente rectangular alta
Plateau rectangular haut



| REF | W x D x H cm | € / u | |
|--------|--------------|-------|---|
| P22038 | 35 x 25 x 5 | 31,50 | 3 |

P22164 High oblong serving dish
Fuente rectangular alta
Plateau rectangular haut



| REF | W x D x H cm | € / u | |
|--------|--------------|-------|---|
| P22164 | 25 x 15 x 7 | 12,85 | 3 |
| P22165 | 35 x 25 x 7 | 26,70 | 3 |
| P22166 | 45 x 30 x 7 | 34,40 | 2 |

P22103 5 - Compartment bowl
Bandeja 5 compartimentos
Bol 5 compartiments



IDEA! Central space ideal for sauces and dips.
Espacio central ideal para salsas y dips.
Espace central idéal pour sauces et tartiner.

| REF | Ø cm | H cm | € / u | |
|--------|------|------|-------|---|
| P22103 | 38 | 6,5 | 32,40 | 3 |

Sharing 13

Me
Melamine

P22501 Oval serving dish
Fuente oval
Plat ovale



| REF | W x D x H cm | € / u | |
|--------|-----------------|-------|---|
| P22501 | 32,5 x 20 x 4 | 13,00 | 1 |
| P22502 | 43,5 x 26,5 x 4 | 21,25 | 1 |

P2210 Round bowl
Bol redondo
Bol rond



| REF | Ø cm | H cm | € / u | |
|--------|------|------|-------|---|
| P22100 | 16 | 9 | 6,55 | 6 |
| P22101 | 26 | 10 | 15,30 | 6 |
| P22102 | 36 | 13 | 26,70 | 3 |

P2222 Bamboo displayer with 3 bowls
Expositor bambú con 3 bols
Présentoir bambou avec 3 bols

Wo
Wood

Me
Melamine



| REF | L cm | Ø cm | H cm | Lts | € / u | |
|--------|------|------|------|------|-------|---|
| P22220 | 29,0 | 11 | 3,5 | 0,20 | 39,70 | 6 |
| P22221 | 40,0 | 13 | 6,0 | 0,50 | 49,15 | 6 |
| P22222 | 49,5 | 16 | 8,5 | 1,10 | 80,00 | 6 |

P2216 Conical bowl
Bol cónico
Bol conique



| REF | Ø cm | H cm | € / u | |
|--------|------|------|-------|---|
| P22167 | 13 | 8,5 | 5,55 | 6 |
| P22168 | 16 | 10,8 | 11,15 | 6 |

P22003 Squared display plate
Bandeja exhibición cuadrada
Plateau carré présentation



| REF | W x D x H cm | € / u | |
|---------|--------------|-------|---|
| P220031 | 31 x 31 x 4 | 16,15 | 3 |
| P22003 | 35 x 35 x 4 | 29,10 | 3 |
| P220033 | 42 x 42 x 5 | 38,35 | 3 |

P22177 Round plate
Bandeja redonda
Plateau rond



| REF | Ø cm | H cm | € / u | |
|--------|------|------|-------|---|
| P22177 | 35 | 3,5 | 27,20 | 3 |



Me
Melamine



Me
Melamine

P22002 Squared display plate
Bandeja exhibición cuadrada
Plateau carré présentation

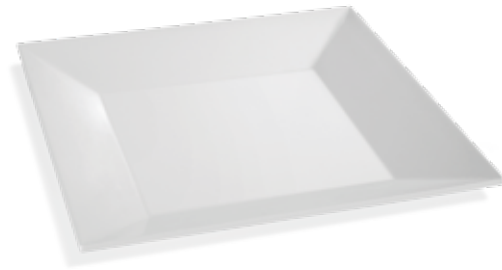

| REF | W x D x H cm | €/ u | |
|---------|-------------------|-------|---|
| P220021 | 30,5 x 30,5 x 3,5 | 23,95 | 3 |
| P22002 | 35,5 x 30,5 x 4 | 27,50 | 3 |
| P220023 | 40,5 x 40,5 x 4,5 | 35,50 | 3 |

P222 Deep squared bowl
Bol cuadrado hondo
Bol carré



| REF | W x D x H cm | €/ u | |
|---------|----------------|-------|----|
| P22211 | 7 x 7 x 4,2 | 3,00 | 24 |
| P22200 | 9 x 9 x 5,5 | 3,95 | 12 |
| P22201 | 13 x 13 x 7 | 7,20 | 6 |
| P22202* | 18 x 18 x 8,5 | 11,95 | 6 |
| P22203 | 24 x 24 x 10 | 18,20 | 3 |
| P22204 | 30 x 30 x 11,5 | 25,65 | 3 |

P2200 Squared tray
Fuente cuadrada
Plateau carré



| REF | W x D x H cm | €/ u | |
|--------|-------------------|-------|---|
| P22001 | 33,5 x 33,5 x 5,5 | 28,20 | 3 |
| P22000 | 37,3 x 37,3 x 2,8 | 32,20 | 3 |

P2201 Oblong plate
Fuente rectangular
Plateau rectangulaire



| REF | W x D x H cm | €/ u | |
|--------|-------------------|-------|---|
| P22012 | 35,8 x 20,5 x 3,8 | 18,90 | 3 |
| P22013 | 44,3 x 22,1 x 4,4 | 23,15 | 3 |
| P22014 | 49,5 x 27,2 x 5,6 | 31,20 | 3 |
| P22015 | 55,7 x 32,2 x 5,2 | 34,70 | 3 |
| P22016 | 71 x 40,5 x 5,3 | 48,60 | 3 |

P2220 Two tones deep squared bowl
Bol cuadrado hondo dos colores
Bol carré deux couleurs



| REF | W x D x H cm | Red Rojo | Blue Azul | Yellow Amarillo | Green Verde | Black Negro | €/ u | |
|--------|----------------|-------------|--------------|--------------------|----------------|----------------|-------|----|
| P22200 | 9 x 9 x 5,5 | R | A | AM | V | N | 4,65 | 12 |
| P22202 | 18 x 18 x 8,5* | R | A | AM | V | N | 14,25 | 6 |
| P22203 | 24 x 24 x 10 | R | A | AM | V | N | 21,65 | 3 |

REF + Color code / REF + Código color / REF + Code couleur

See products on
Ver productos en / Voir produits en page

P. 415

- * Fits in CUBIC display.
- * Encaja en expositores CUBIC.
- * Adaptable aux présentoirs CUBIC.



P2208 Oblong display tray
Bandeja exhibición rectangular
Plateau rectangulaire



| REF | W x D x H cm | €/ u | |
|--------|---------------|------|---|
| P22085 | 39 x 15 x 1,5 | 6,70 | 6 |
| P22086 | 50 x 18 x 1,8 | 9,20 | 6 |

P22099 Bowl - plate
Plato - bol
Plat - bol



| REF | Ø cm | H cm | €/ u | |
|--------|------|------|-------|---|
| P22099 | 38 | 9 | 24,55 | 6 |

P2215 Gastronorm tray
Bandeja gastronorm
Plateau gastronorme



| REF | W x D x H cm | €/ u | |
|--------|-----------------|-------|---|
| P22150 | 53 x 32,5 x 2 | 25,20 | 3 |
| P22151 | 32,5 x 26,5 x 2 | 19,90 | 6 |

P22004 Deep squared bowl
Bol cuadrado
Bol carré



| REF | W x D x H cm | €/ u | |
|--------|-----------------|-------|---|
| P22004 | 25 x 25 x 8,8 | 20,80 | 3 |
| P22005 | 37,5 x 37,5 x 9 | 37,45 | 3 |

13 Complet Table



Me
Melamine

P2211 Round dish
Plato
Assiette plate



| REF | Ø cm | H cm | €/u | 📦 |
|--------|------|------|------|----|
| P22111 | 16,0 | 2,3 | 4,10 | 12 |
| P22112 | 20,0 | 2,3 | 6,25 | 12 |
| P22113 | 23,0 | 2,3 | 7,70 | 6 |
| P22114 | 26,5 | 2,3 | 8,80 | 6 |

P22115 Soup plate
Plato sopa
Assiette à soupe



| REF | Ø cm | H cm | €/u | 📦 |
|--------|------|------|------|---|
| P22115 | 24 | 3,7 | 8,05 | 6 |

P22116 Big salad bowl
Bol grande
Saladier grand



| REF | Ø cm | H cm | €/u | 📦 |
|--------|------|------|------|---|
| P22116 | 19 | 5 | 6,25 | 6 |

P22182 Oval dish
Plato oval
Assiette ovale



| REF | W x D x H cm | €/u | 📦 |
|--------|-------------------|-------|---|
| P22182 | 24,3 x 18,2 x 2,1 | 6,80 | 6 |
| P22183 | 30,5 x 23,2 x 2,5 | 9,80 | 6 |
| P22184 | 34,2 x 26,8 x 2,7 | 11,80 | 6 |

Complet Table 13

Me
Melamine

P2225 Stackable bowl
Bol cereales encastable
Bol empilable



| REF | Ø cm | H cm | €/u | 📦 |
|--------|------|------|------|----|
| P22250 | 12 | 4,5 | 4,65 | 12 |
| P22251 | 14 | 5,5 | 6,90 | 12 |

P22117 Small salad bowl
Bol pequeño
Saladier petit



| REF | Ø cm | H cm | €/u | 📦 |
|--------|------|------|------|----|
| P22117 | 14 | 6 | 4,90 | 12 |

P22178 Cup - Plate
Taza - Plato
Tasse - Assiette



| | REF | Size | Ø cm | H cm | Lts | €/u | 📦 |
|---------------------------|--------|------|------|------|------|------|----|
| Cup / Taza Tasse | P22178 | S | 7,0 | 4,8 | 0,10 | 3,60 | 12 |
| | P22180 | L | 9,8 | 6,5 | 0,25 | 6,80 | 12 |
| Plate / Plato Assiette | P22179 | S | 10,3 | - | - | 1,95 | 12 |
| | P22181 | L | 14,4 | - | - | 3,70 | 12 |

P22118 Stackable mug
Taza apilable
Tasse empilable



| REF | Ø cm | H cm | Lts | €/u | 📦 |
|--------|------|------|------|------|---|
| P22118 | 7,5 | 10 | 0,30 | 5,40 | 6 |

P22033 Slotted spoon
Cuchara perforada
Cuillère ajourée



| REF | L cm | €/u | 📦 |
|--------|------|------|----|
| P22033 | 30 | 2,90 | 24 |

P22034 Soup ladle
Cacillo
Louche



| REF | L cm | Lts | €/u | 📦 |
|--------|------|------|------|----|
| P22034 | 17 | 0,08 | 2,90 | 24 |

13 Venus



P22023 Oval plate
Fuente oval honda
Plateau ovale



| REF | W x D x H cm | € / u | |
|--------|---------------|-------|---|
| P22023 | 50 x 36 x 6,7 | 25,40 | 3 |

P22022 Round bowl
Fuente redonda
Bol rond



| REF | Ø cm | H cm | € / u | |
|--------|------|------|-------|---|
| P22022 | 36 | 7 | 24,75 | 3 |

P22019 Round bowl
Bol redondo
Bol rond



| REF | Ø cm | H cm | € / u | |
|--------|------|------|-------|---|
| P22019 | 20 | 9,0 | 15,65 | 3 |
| P22020 | 28 | 12,5 | 29,25 | 3 |

P22174 Slanted round bowl
Bol redondo inclinado
Bol rond incliné



| REF | W x D x H cm | Lts | € / u | |
|--------|--------------------|------|-------|---|
| P22174 | 21,2 x 20,8 x 10,4 | 0,60 | 16,60 | 6 |
| P22175 | 30 x 29,1 x 13,7 | 1,60 | 28,50 | 3 |
| P22176 | 36 x 34,9 x 16,3 | 2,85 | 40,60 | 3 |

P22090 Round plate presentation
Plato redondo de presentación
Plateau rond présentation



| REF | Ø cm | H cm | € / u | |
|--------|------|------|-------|---|
| P22090 | 31 | 2 | 16,50 | 4 |

P22364 Round bowl
Bol redondo
Bol rond



| REF | Ø cm | H cm | € / u | |
|--------|------|------|-------|---|
| P22364 | 22,5 | 11,5 | 10,35 | 3 |
| P22365 | 26,0 | 14,0 | 17,20 | 3 |

Wood board 13



P2260 Oak display plate
Soporte presentación roble
Présentoir chêne



With non-slip feet
Con pies antideslizantes
Avec pieds antidérapants



| REF | Mod. | cm | € / u | |
|--------|------|-------------|-------|---|
| P22600 | 1/1 | 53,0 x 32,5 | 61,75 | 3 |
| P22601 | 1/2 | 32,5 x 26,5 | 32,70 | 6 |
| P22602 | 1/3 | 32,5 x 17,6 | 23,10 | 6 |
| P22603 | 1/4 | 26,5 x 16,2 | 19,10 | 6 |
| P22604 | 2/4 | 53,0 x 16,5 | 30,55 | 6 |

P2262 Oak serving tray
Bandeja presentación roble
Plateau présentation bois



| REF | W x D x H cm | € / u | |
|--------|---------------|-------|----|
| P22620 | 30 x 15 x 1,8 | 14,00 | 12 |
| P22621 | 30 x 20 x 1,8 | 16,75 | 12 |
| P22622 | 40 x 30 x 1,8 | 24,55 | 6 |

P2261 Display plate
Soporte presentación
Présentoir



With non-slip feet
Con pies antideslizantes
Avec pieds antidérapants

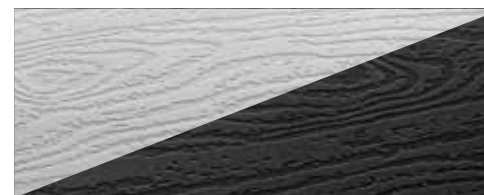

| REF | Mod. | cm | Blanco White Blanc | Negro Black Noir | € / u | |
|--------|------|-------------|--------------------------|------------------------|-------|---|
| P22610 | 1/1 | 53,0 x 32,5 | B | N | 61,75 | 3 |
| P22611 | 1/2 | 32,5 x 26,5 | B | N | 32,70 | 4 |
| P22614 | 2/4 | 53,0 x 16,5 | B | N | 30,55 | 6 |

REF + color code / REF + código color / REF + code couleur

P22664 White wood serving tray
Soporte presentación madera blanca
Plateau présentation bois blanc



| REF | Mod. | W x D x H cm | € / u | |
|--------|------|-----------------|-------|----|
| P22660 | 1/1 | 53 x 32,5 x 1 | 60,20 | 6 |
| P22661 | 1/2 | 32,5 x 26,5 x 1 | 31,80 | 24 |
| P22662 | 1/3 | 32,5 x 17,6 x 1 | 22,50 | 24 |
| P22663 | 1/4 | 26,5 x 16,2 x 1 | 18,65 | 24 |
| P22664 | 2/4 | 53 x 16,3 x 1 | 29,85 | 12 |

P22690 Slate display plate
Soporte presentación pizarra
Présentoir base ardoise



| REF | Mod. | W x D x H cm | € / u | |
|--------|------|-----------------|-------|----|
| P22690 | 1/2 | 32,5 x 26,5 x 1 | 24,55 | 24 |
| P22691 | 1/3 | 32,5 x 17,5 x 1 | 16,60 | 24 |
| P22692 | 1/4 | 26,5 x 16,0 x 0 | 13,55 | 24 |

P2264 Slate display plate
Bandeja base pizarra
Présentoir base ardoise

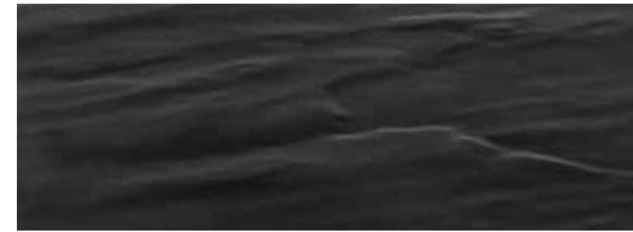

| REF | Mod. | cm | € / u | |
|---------|------|-------------|-------|---|
| P22640N | 1/2 | 32,5 x 26,5 | 33,10 | 6 |
| P22641N | 1/3 | 32,5 x 17,5 | 23,10 | 6 |
| P22642N | 1/4 | 26,5 x 16,0 | 19,10 | 6 |

P22161 Slate - granite Display plate
Soporte presentación Pizarra - granito
Presentoir Ardoise - granite



Reversible: 1 slate side - 1 granite side
Reversible: 1 cara pizarra - 1 cara granito
Réversible: 1 face ardoise - 1 face granite



| REF | Mod. | W x D x H cm | € / u | |
|--------|------|-------------------|-------|---|
| P22161 | 1/1 | 53,0 x 32,5 x 0,7 | 50,60 | 3 |
| P22162 | 1/2 | 32,5 x 26,5 x 0,7 | 26,30 | 3 |

P22124 Display plate
Soporte presentación
Présentoir



| REF | Ø cm | H cm | € / u | |
|--------|------|------|-------|---|
| P22124 | 23,0 | 1,5 | 11,90 | 1 |
| P22125 | 28,0 | 1,5 | 16,45 | 1 |
| P22126 | 32,5 | 1,5 | 21,40 | 1 |

P22144 Double face slate - bamboo display plate
P22145 Soporte presentación doble cara pizarra - bambú
Présentoir double face bambou - ardoise



Reversible: 1 slate side - 1 bamboo side
Reversible: 1 cara pizarra - 1 cara bambú
Réversible: 1 face ardoise - 1 face bambou

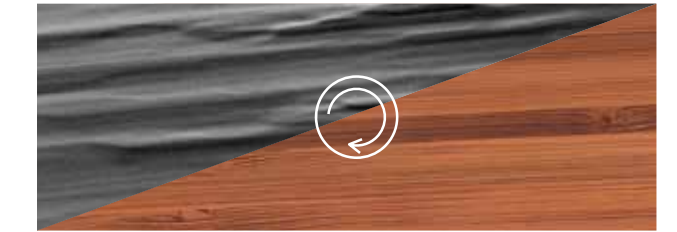

| REF | Ø cm | H cm | € / u | |
|--------|------|------|-------|---|
| P22144 | 33 | 1 | 44,70 | 3 |
| P22145 | 43 | 1 | 65,55 | 3 |

P22695 Marble display plate
Soporte presentación mármol
Présentoir base marbre



| REF | Mod. | W x D x H cm | € / u | |
|---------|------|-----------------|-------|----|
| P22695 | 1/1 | 53,0 x 32,5 x 2 | 49,25 | 9 |
| P22696 | 1/2 | 32,5 x 26,5 x 2 | 23,30 | 12 |
| P22697 | 1/3 | 32,5 x 17,6 x 2 | 16,60 | 24 |
| P22698* | | 15 x 15 x 9,5 | 8,05 | 48 |

13 GN Classic Colors



GN 1/1 530 x 325 mm

Yellow
Amarillo
Jaune



| REF | H mm | € / u | |
|--------|------|-------|---|
| P22866 | 20 | 21,80 | 6 |
| P22867 | 40 | 33,15 | 3 |
| P22868 | 65 | 49,25 | 2 |

Orange
Naranja
Orange



| REF | H mm | € / u | |
|--------|------|-------|---|
| P22863 | 20 | 21,80 | 6 |
| P22864 | 40 | 33,15 | 3 |
| P22865 | 65 | 49,25 | 2 |

Red
Rojo
Rouge



| REF | H mm | € / u | |
|--------|------|-------|---|
| P22869 | 20 | 21,80 | 6 |
| P22870 | 40 | 33,15 | 3 |
| P22871 | 65 | 49,25 | 2 |

Grey
Gris
Gris



| REF | H mm | € / u | |
|--------|------|-------|---|
| P22860 | 20 | 21,80 | 6 |
| P22861 | 40 | 33,15 | 3 |
| P22862 | 65 | 49,25 | 2 |

GN 1/2 325 x 265 mm

Yellow
Amarillo
Jaune



| REF | H mm | € / u | |
|--------|------|-------|---|
| P22878 | 20 | 11,65 | 6 |
| P22879 | 40 | 21,20 | 3 |
| P22880 | 65 | 26,00 | 2 |

Orange
Naranja
Orange



| REF | H mm | € / u | |
|--------|------|-------|---|
| P22875 | 20 | 11,65 | 6 |
| P22876 | 40 | 21,20 | 3 |
| P22877 | 65 | 26,00 | 2 |

Red
Rojo
Rouge



| REF | H mm | € / u | |
|--------|------|-------|---|
| P22881 | 20 | 11,65 | 6 |
| P22882 | 40 | 21,20 | 3 |
| P22883 | 65 | 26,00 | 2 |

Grey
Gris
Gris



| REF | H mm | € / u | |
|--------|------|-------|---|
| P22872 | 20 | 11,65 | 6 |
| P22873 | 40 | 21,20 | 3 |
| P22874 | 65 | 26,00 | 2 |

GN Classic Black 13



GN 1/1 530 x 325 mm



| REF | H mm | € / u | |
|--------|------|-------|---|
| P22051 | 20 | 20,45 | 6 |
| P22053 | 40 | 29,05 | 3 |
| P22009 | 65 | 44,75 | 2 |

GN 2/3 353 x 325 mm



| REF | H mm | € / u | |
|--------|------|-------|---|
| P22047 | 65 | 48,10 | 3 |

GN 2/4 530 x 162 mm



| REF | H mm | € / u | |
|--------|------|-------|---|
| P22049 | 65 | 26,70 | 3 |

GN 1/3 325 x 175 mm



| REF | H mm | € / u | |
|--------|------|-------|---|
| P22011 | 65 | 17,45 | 3 |
| P22080 | 100 | 23,20 | 3 |

GN 1/2 325 x 265 mm



| REF | H mm | € / u | |
|--------|------|-------|---|
| P22039 | 20 | 11,00 | 6 |
| P22041 | 40 | 19,95 | 3 |
| P22010 | 65 | 23,50 | 3 |
| P22084 | 100 | 29,90 | 3 |

GN 1/4 265 x 162 mm



| REF | H mm | € / u | |
|--------|------|-------|---|
| P22043 | 65 | 16,75 | 3 |

GN 1/6 176 x 162 mm



| REF | H mm | € / u | |
|--------|------|-------|---|
| P22045 | 65 | 12,00 | 6 |
| P22082 | 100 | 16,40 | 6 |



GN Slim 13

GN 1/1 530 x 325 mm



| REF | H mm | €/u | |
|--------|------|-------|----|
| P23030 | 20 | 19,10 | 12 |
| P23031 | 65 | 41,65 | 6 |
| P23032 | 100 | 51,75 | 6 |

GN 1/2 325 x 265 mm



| REF | H mm | €/u | |
|--------|------|-------|----|
| P23033 | 20 | 10,20 | 24 |
| P23034 | 65 | 21,90 | 12 |

GN 2/4 530 x 162 mm



| REF | H mm | €/u | |
|--------|------|-------|----|
| P23044 | 20 | 20,35 | 12 |
| P23045 | 65 | 24,80 | 12 |
| P23046 | 100 | 29,25 | 12 |

GN 1/3 325 x 176 mm



| REF | H mm | €/u | |
|--------|------|-------|----|
| P23036 | 20 | 9,65 | 24 |
| P23037 | 65 | 16,25 | 24 |
| P23038 | 100 | 21,60 | 12 |

GN SLIM SLIM PAN CUBETA LIGERA BAC LÉGER

ECONOMIC LINE
GAMA ECONÓMICA
GAMME ECONOMIQUE

IDEA! Ideal for cold buffets.
Ideal buffets fríos.
Idéal pour buffets froids

Stackable
Apilable
Empilable

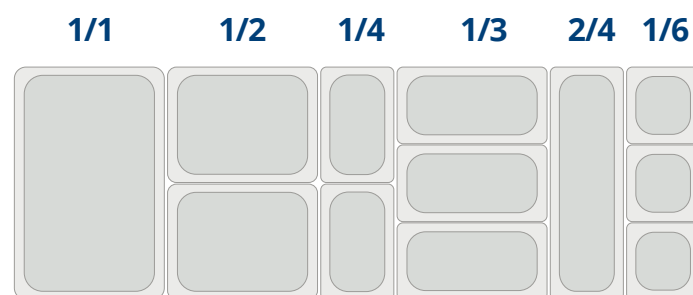

GN 1/4 265 x 162 mm



| REF | H mm | €/u | |
|--------|------|-------|----|
| P23039 | 20 | 11,95 | 48 |
| P23040 | 65 | 18,10 | 24 |

GN 1/6 176 x 162 mm



| REF | H mm | €/u | |
|--------|------|-------|----|
| P23042 | 65 | 11,15 | 24 |
| P23043 | 100 | 15,35 | 24 |



GN 1/1 530 x 325 mm



| REF | H mm | €/u | |
|--------|------|-------|---|
| P22052 | 20 | 20,45 | 6 |
| P22054 | 40 | 29,05 | 3 |
| P22006 | 65 | 44,75 | 2 |

GN 1/2 325 x 265 mm



| REF | H mm | €/u | |
|--------|------|-------|---|
| P22040 | 20 | 11,00 | 6 |
| P22042 | 40 | 19,95 | 3 |
| P22007 | 65 | 23,50 | 3 |
| P22083 | 100 | 29,90 | 3 |

GN 2/3 353 x 325 mm



| REF | H mm | €/u | |
|--------|------|-------|---|
| P22048 | 65 | 35,75 | 3 |

GN 1/3 325 x 175 mm



| REF | H mm | €/u | |
|--------|------|-------|---|
| P22094 | 20 | 12,30 | 6 |
| P22008 | 65 | 17,45 | 3 |
| P22079 | 100 | 23,20 | 3 |

GN 2/4 530 x 162 mm



| REF | H mm | €/u | |
|--------|------|-------|---|
| P22087 | 20 | 21,95 | 6 |
| P22050 | 65 | 26,70 | 3 |

GN 1/4 265 x 162 mm



| REF | H mm | €/u | |
|--------|------|-------|---|
| P22044 | 65 | 16,75 | 3 |

GN 1/6 176 x 162 mm



| REF | H mm | €/u | |
|--------|------|-------|---|
| P22046 | 65 | 12,00 | 6 |
| P22081 | 100 | 16,40 | 6 |

P22154 1/1 Gastronorm buffet displayer Expositor buffet para cubetas GN 1/1 Présentoir buffet pour bacs GN 1/1



| REF | tipo/type | W x D x H cm | €/u | |
|--------|-----------|--------------------|-------|---|
| P22154 | 1/1 | 56,5 x 52,5 x 32,5 | 39,90 | 6 |

P22156 1/3 Gastronorm buffet displayer Expositor buffet para cubetas GN 1/3 Présentoir buffet pour bacs GN 1/3



Containers not included
Cubetas no incluidas
Bacs non inclus

| REF | tipo/type | W x D x H cm | €/u | |
|--------|-----------|------------------|-------|---|
| P22156 | 1/3 | 36 x 52,5 x 32,5 | 46,50 | 6 |

P22158 4 Cocks system stand Expositor 4 vasijas Présentoir 4 cruches



P22160
Cocks not included
Vasijas no incluidas
Cruches pas incluses

| REF | W x D x H cm | €/u | |
|--------|------------------|-------|---|
| P22158 | 19 x 52,5 x 32,5 | 42,15 | 6 |

P22160 1l crock Vasija 1l Cruche 1l



| REF | Ø cm | H cm | €/u | |
|--------|------|------|------|---|
| P22160 | 13 | 10,5 | 8,15 | 6 |

13 Mini White



P22108 Squared bowl
Platillo cuadrado
Bol carré



| REF | W x D x H cm | Lts | €/u | |
|--------|-------------------|------|------|----|
| P22108 | 10 x 10 x 3,3 | 0,10 | 1,95 | 24 |
| P22109 | 12,5 x 12,5 x 3,5 | 0,18 | 2,35 | 24 |

P22088 Egg cup
Platillo para huevo
Coquetier



| REF | W x D x H cm | €/u | |
|--------|-----------------|------|----|
| P22088 | 11,5 x 11,5 x 2 | 2,65 | 24 |

P22119 Snack or sauce melamine tray
Bandeja melamina snacks o salsas
Plateaux mélamine snacks ou sauces



NEW!

2 compartments
2 compartimentos
2 compartiments

| REF | W x D x H cm | €/u | |
|--------|------------------|------|---|
| P22119 | 17,5 x 8,5 x 3,5 | 3,90 | 1 |

P867 Ramekin
Recipiente para salsas
Récipient pour sauces



P22104 Mini square plate
Mini bandeja presentación
Plateau miniature



| REF | W x D x H cm | €/u | |
|--------|-----------------|------|----|
| P22104 | 12,5 x 10,5 x 2 | 2,40 | 24 |
| P22105 | 14 x 13 x 2 | 3,20 | 24 |
| P22106 | 17 x 14 x 2,5 | 4,90 | 24 |

P22890 Small tray
Fuente rectangular
Ravier rectangulaire



Stackable
Apilable
Empilable

| REF | W x D x H cm | €/u | |
|--------|--------------|------|----|
| P22890 | 13 x 9 x 2 | 4,75 | 24 |

P22110 Party spoon
Cuchara degustación
Cuillère amuse bouche



| REF | W x D x H cm | €/u | |
|--------|----------------|------|----|
| P22110 | 14,5 x 4,5 x 5 | 0,95 | 60 |

| REF | Ø cm | H cm | €/u | |
|---------|------|------|------|----|
| P867030 | 5,8 | 2,7 | 2,25 | 12 |
| P867060 | 7,0 | 3,7 | 2,70 | 12 |
| P867090 | 7,8 | 4,0 | 3,40 | 12 |
| P867120 | 8,5 | 4,5 | 4,15 | 12 |



Mini Black 13

P23840 Mini oval casserole
Mini cacerola oval
Mini casserole ovale



| REF | W x D x H cm | L cm | €/u | |
|--------|---------------|------|------|----|
| P23840 | 12 x 8 x 3,5 | 15,5 | 2,80 | 96 |
| P23841 | 21 x 14 x 3,5 | 26,5 | 7,55 | 96 |

P23830 Mini hot plate with handles
Mini parrilla con asas
Mini grill avec poignées



| REF | W x D x H cm | L cm | €/u | |
|--------|--------------|------|-------|----|
| P23830 | 26 x 16 x 2 | 32 | 13,60 | 96 |

P23825 Mini round fry pan
Mini sartén redonda
Mini poêle ronde



| REF | Ø cm | L cm | H cm | €/u | |
|--------|------|------|------|------|----|
| P23825 | 11 | 16 | 3,0 | 3,70 | 96 |

P23836 Mini round casserole
Mini cacerola redonda
Mini cocotte ronde



| REF | Ø cm | L cm | H cm | €/u | |
|--------|------|------|------|------|----|
| P23835 | 11,5 | 15 | 3,5 | 3,70 | 96 |
| P23836 | 14,5 | 19 | 3,5 | 5,60 | 96 |

P23824 Mini squared fry pan
Mini sartén cuadrada
Mini poêle carrée



| REF | W x D x H cm | L cm | €/u | |
|--------|-----------------|------|------|----|
| P23824 | 12,5 x 10,5 x 2 | 16 | 4,60 | 96 |

P23800 Mini round casserole with lid
Mini cacerola con tapa
Mini cocotte avec couvercle



| REF | Ø cm | H cm | L cm | €/u | |
|--------|------|------|------|-------|---|
| P23800 | 10 | 6,5 | 0,25 | 11,65 | 1 |
| P23810 | 14 | 8,0 | 0,75 | 16,20 | 1 |

See colors on
Ver colores en
Voir couleurs
en page

P. 358

13 Mini Black



P23842 Mini casserole
Mini cacerola
Mini cocotte



| REF | Ø cm | H cm | €/u | |
|--------|------|------|------|---|
| P23842 | 9 | 4,5 | 2,65 | 1 |

P23843 Mini oval casserole
Mini cacerola oval
Mini cocotte ovale



| REF | W x D x H cm | €/u | |
|--------|--------------|------|---|
| P23843 | 18 x 13 x 4 | 4,45 | 1 |

P23844 Mini rectangular casserole
Mini cacerola rectangular
Mini casserole rectangulaire



| REF | W x D x H cm | €/u | |
|--------|---------------|------|---|
| P23844 | 19,5 x 10 x 5 | 4,55 | 1 |

P23845 Mini round fry pan
Mini sartén redonda
Mini poêle ronde



| REF | Ø cm | L cm | H cm | €/u | |
|--------|------|------|------|-------|---|
| P23845 | 21,5 | 30,5 | 3,0 | 11,00 | 1 |

P22120 Snacks or sauce tray
Bandeja snacks o salsas
Plateaux sauces



| REF | W x D x H cm | €/u | |
|--------|------------------|------|---|
| P22120 | 17,5 x 8,5 x 3,5 | 3,90 | 1 |

P2293 Snacks or sauce tray
Bandeja snacks o salsas
Plateaux sauces



| REF | W x D x H cm | €/u | |
|--------|-----------------|------|----|
| P22920 | 19 x 8 x 3 | 7,35 | 12 |
| P22930 | 9,2 x 6,9 x 3,1 | 3,80 | 24 |

Ashtrays 13

Ceniceros
Cendriers



P22035 Squared ashtray. Black
Cenicero cuadrado. Negro
Cendrier carré. Noir



| REF | W x D x H cm | €/u | |
|--------|--------------|------|---|
| P22035 | 9 x 9 x 3 | 1,50 | 1 |

P22036 Round ashtray. Black
Cenicero redondo. Negro
Cendrier rond. Noir



| REF | Ø cm | H cm | €/u | |
|--------|------|------|------|---|
| P22036 | 10 | 4,5 | 1,70 | 1 |

P22030 Windproof ashtray round with lid. Black
Cenicero redondo con tapa. Negro
Cendrier pour l'exterieur avec couvercle. Noir



| REF | Ø cm | H cm | €/u | |
|--------|------|------|------|---|
| P22030 | 14,5 | 6,0 | 8,00 | 6 |

P22031 Round dinner ashtray. Black
Cenicero redondo. Negro
Cendrier rond. Noir



| REF | Ø cm | H cm | €/u | |
|--------|------|------|------|----|
| P22031 | 10 | 5,0 | 1,30 | 12 |

P22185 Conical melamine ashtray. Black
Cenicero cónico melamina. Negro
Cendrier conique. Noir



| REF | Ø cm | H cm | €/u | |
|--------|------|------|------|----|
| P22185 | 10 | 2,7 | 1,85 | 24 |

MELAMINE
MELAMINA
MELAMINE

MELAMINE
MELAMINA
MELAMINE

14 Buffet & accessories

Buffet y accesorios

Buffet et accessoires



| | |
|--|-----|
| 14.1 DISPLAY STANDS & BASKETS | 386 |
| <i>PRESENTACIÓN Y EXPOSITORES</i> <i>PRÉSENTOIRS ET PRÉSENTOIRS CORBEILLES</i> | |
| 14.2 PROTECTION AND COVERS | 394 |
| <i>PROTECCIÓN Y TAPAS / PROTECTION ET COUVERCLES</i> | |
| 14.3 BRONZE COOKWARE | 398 |
| <i>BATERÍA DE COCINA BRONCE / BATTERIE DE CUISINE BRONZE</i> | |
| 14.4 COOL-LINE COLLECTION | 400 |
| 14.5 SUPER SHAPES | 402 |
| <i>BUFFET PRESENTATION STEAM TABLE PANS</i> <i>CUBETAS PRESENTACIÓN BUFFET / BACS PRÉSENTATION BUFFET</i> | |
| 14.6 MIRAMAR® COOKWARE | 406 |
| <i>BATERÍA DE COCINA PARA PRESENTACIÓN</i> <i>BATTERIE DE CUISINE-PRÉSENTATION</i> | |
| 14.7 CUBIC | 412 |
| 14.8 CHAFERS & DISPENSERS | 428 |
| <i>CHAFINGS Y DISPENSADORES / CHAFERS ET DISTRIBUTEURS</i> | |
| 14.9 BOWLS & SERVING TRAYS | 436 |
| <i>BOLS & BANDEJAS DE SERVICIO / BOLS & PLATEAUX</i> | |
| 14.10 SERVING TOOLS | 440 |
| <i>UTENSILIOS DE SERVICIO / USTENSILES DE SERVICE BUFFET</i> | |
| 14.11 SIGNS | 450 |
| <i>SEÑALIZACIÓN / SIGNALIZATION</i> | |

14.1 Display stands & baskets

Presentación y expositores
Présentoirs et présentoirs corbeilles



NEW!

P598001 One tier flat display stand

Expositor metálico recto de un nivel
Présentoir métallique droit à un niveau



Baskets not included
Cestas no incluidas
Panniers non inclus



| REF | W x D x H cm | €/u | |
|---------|----------------|-------|---|
| P598001 | 45 x 30 x 20,5 | 33,00 | 1 |

P598002 One tier angled display stand

Expositor metálico inclinado de un nivel
Présentoir métallique incliné à un niveau



Baskets not included
Cestas no incluidas
Panniers non inclus



| REF | W x D x H cm | €/u | |
|---------|----------------|-------|---|
| P598002 | 45 x 30 x 14,5 | 37,15 | 1 |

P598003 Three tier flat display stand

Expositor metálico recto de 3 niveles
Présentoir métallique droit 3 niveaux



Baskets not included
Cestas no incluidas
Panniers non inclus



| REF | W x D x H cm | €/u | |
|---------|----------------|-------|---|
| P598003 | 30 x 24 x 51,5 | 58,05 | 1 |

Display stands & baskets 14.1

Presentación y expositores
Présentoirs et présentoirs corbeilles

NEW!

P591006 Rectangular metal wire basket

Cesta metálica rectangular
Panier métallique rectangulaire



Suitable for
Combinable con
Adaptable pour
P598001 / P598002



| REF | W x D x H cm | €/u | |
|---------|--------------|-------|---|
| P591006 | 45 x 30 x 5 | 18,95 | 1 |

P591007 Rectangular metal wire basket

Cesta metálica rectangular
Panier métallique rectangulaire



Suitable for
Combinable con
Adaptable pour
P598003



| REF | W x D x H cm | €/u | |
|---------|---------------|-------|---|
| P591007 | 30 x 22,5 x 5 | 15,65 | 1 |

P595001 Wooden box

Caja de madera
Caisse en bois



dishwasher

Suitable for
Combinable con
Adaptable pour
P598001 / P598002

Stackable
Apilables
Empilables



| REF | W x D x H cm | €/u | |
|---------|--------------|-------|---|
| P595001 | 45 x 30 x 5 | 30,05 | 1 |
| P595002 | 45 x 30 x 10 | 38,75 | 1 |

P595003 Wooden box

Caja de madera
Caisse en bois



dishwasher

Suitable for
Combinable con
Adaptable pour
P598003

Stackable
Apilables
Empilables



| REF | W x D x H cm | €/u | |
|---------|--------------|-------|---|
| P595003 | 30 x 22 x 5 | 28,45 | 1 |
| P595004 | 30 x 22 x 10 | 31,70 | 1 |

14.1 Display stands & baskets

Presentación y expositores
Présentoirs et présentoirs corbeilles



NEW!

Available in 3 colours: black, silver and gold in a matt finish.

Stackable.

Suitable for food contact.

Double functionality: tray and riser.

Made from 2 mm thick anodised aluminium providing great strength and toughness.

Disponibles en 3 colores: negro, plata y dorado en acabado mate.

Apilables.

Apta para contacto alimentario.

Doble funcionalidad: bandeja y riser.

Realizado en aluminio adonizado de 2 mm de grosor que ofrece gran robustez y resistencia.

Disponibles en 3 couleurs : noir, argent et doré en finition mate.

Empilables.

Adapté au contact alimentaire.

Double fonctionnalité : plateau et riser.

Fabriqué en aluminium anodisé de 2 mm d'épaisseur, ce qui lui confère une grande robustesse et une grande résistance.

P317500 GN 1/1 buffet tray
Bandeja buffet GN 1/1
Plateau buffet GN 1/1

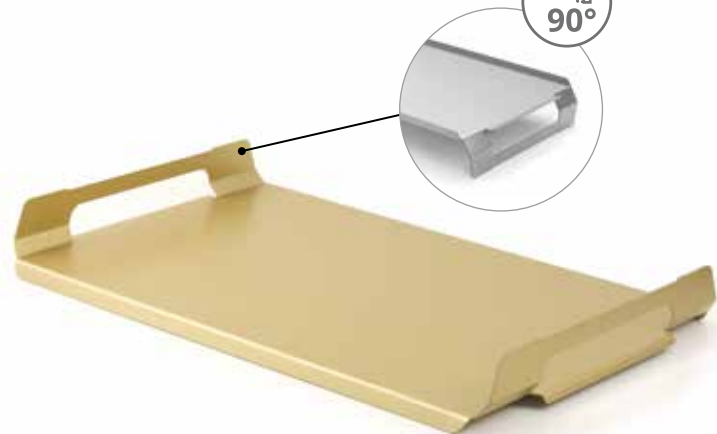

Ref. colour / Ref. color / Ref. couleur couvercle



P317500B / P317500S / P317500G
Adaptable to GN 1/1 trolleys and food transport boxes with guides.

Adaptables a carros GN 1/1 y cajas de transporte de alimentos con guías.

Adaptables aux chariots GN 1/1 et aux caisses de transport de nourriture avec guides.



Click on the top of the handle to stack the trays stable and secure.

Encaje en la parte superior del asa para apilar las bandejas de forma estable y segura.

Enclenchez le dessus de la poignée pour empiler les plateaux de manière stable et sécurisée.

| REF | Ext. measures Medidas ext. Dimensions ext. W x D x H cm | Usable surface Superficie útil Surface utile cm | €/u | 📦 |
|----------|--|--|-------|---|
| P317500B | 53 x 32,5 x 6,5 | 49,2 x 31 | 47,95 | 1 |
| P317500S | 53 x 32,5 x 6,5 | 49,2 x 31 | 47,95 | 1 |
| P317500G | 53 x 32,5 x 6,5 | 49,2 x 31 | 47,95 | 1 |

Display stands & baskets 14.1

Presentación y expositores
Présentoirs et présentoirs corbeilles



NEW!

P317100 Service and buffet trays
Bandejas de servicio y buffet
Plateaux de service et de buffet

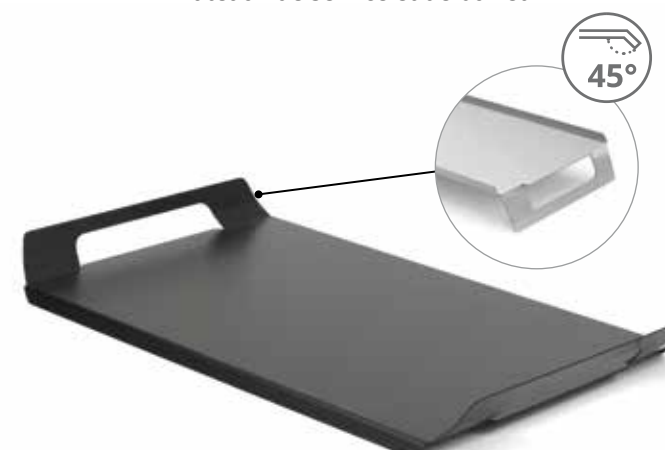

| REF | Ext. measures Medidas ext. Dimensions ext. W x D x H cm | Usable surface Superficie útil Surface utile cm | €/u | 📦 |
|----------|--|--|-------|---|
| P317100B | 53 x 32,5 x 4,6 | 45,5 x 31 | 47,95 | 1 |
| P317100S | 53 x 32,5 x 4,6 | 45,5 x 31 | 47,95 | 1 |
| P317100G | 53 x 32,5 x 4,6 | 45,5 x 31 | 47,95 | 1 |

P317200 Service and buffet trays
Bandejas de servicio y buffet
Plateaux de service et de buffet

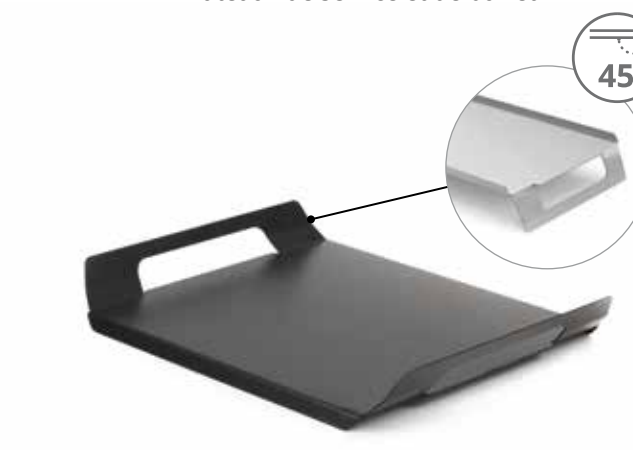

| REF | Ext. measures Medidas ext. Dimensions ext. W x D x H cm | Usable surface Superficie útil Surface utile cm | €/u | 📦 |
|----------|--|--|-------|---|
| P317200B | 43,4 x 32,5 x 4,6 | 36 x 31 | 38,50 | 1 |
| P317200S | 43,4 x 32,5 x 4,6 | 36 x 31 | 38,50 | 1 |
| P317200G | 43,4 x 32,5 x 4,6 | 36 x 31 | 38,50 | 1 |

P317300 Service and buffet trays
Bandejas de servicio y buffet
Plateaux de service et de buffet

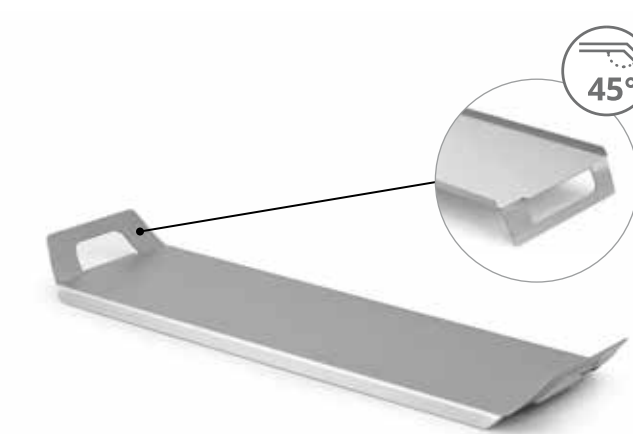

| REF | Ext. measures Medidas ext. Dimensions ext. W x D x H cm | Usable surface Superficie útil Surface utile cm | €/u | 📦 |
|----------|--|--|-------|---|
| P317300B | 51,5 x 18,5 x 4 | 45,5 x 17 | 34,95 | 1 |
| P317300S | 51,5 x 18,5 x 4 | 45,5 x 17 | 34,95 | 1 |
| P317300G | 51,5 x 18,5 x 4 | 45,5 x 17 | 34,95 | 1 |

P317400 Service and buffet trays
Bandejas de servicio y buffet
Plateaux de service et de buffet

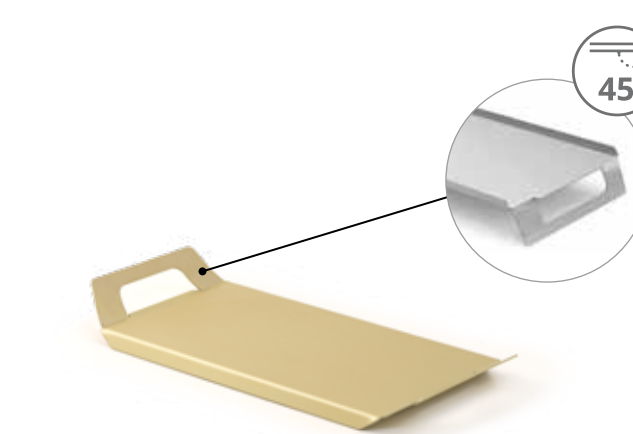

| REF | Ext. measures Medidas ext. Dimensions ext. W x D x H cm | Usable surface Superficie útil Surface utile cm | €/u | 📦 |
|----------|--|--|-------|---|
| P317400B | 39 x 19,5 x 4 | 33 x 18 | 30,95 | 1 |
| P317400S | 39 x 19,5 x 4 | 33 x 18 | 30,95 | 1 |
| P317400G | 39 x 19,5 x 4 | 33 x 18 | 30,95 | 1 |

14.1 Display stands & baskets

Presentación y expositores
Présentoirs et présentoirs corbeilles

Mt
Metal

BUF
FET

BEST
SELLER



P596110 Black GN wire basket
Cesta rejilla GN negra
Pannier metalique GN noir



1/1

| REF | Mod | W x D x H cm | € / u | ☐ |
|---------|-----|----------------|-------|---|
| P596110 | 1/1 | 52 x 31,5 x 12 | 39,10 | 6 |
| P596111 | 1/1 | 52 x 31,5 x 16 | 48,60 | 6 |

P596120 Black GN wire basket
Cesta rejilla GN negra
Pannier metalique GN noir



1/2

| REF | Mod | W x D x H cm | € / u | ☐ |
|---------|-----|------------------|-------|---|
| P596120 | 1/2 | 31,5 x 25,5 x 12 | 27,50 | 6 |
| P596121 | 1/2 | 31,5 x 25,5 x 16 | 36,70 | 6 |

P596130 Black GN wire basket
Cesta rejilla GN negra
Pannier metalique GN noir



1/3

| REF | Mod | W x D x H cm | € / u | ☐ |
|---------|-----|----------------|-------|---|
| P596130 | 1/3 | 31,5 x 17 x 12 | 24,55 | 6 |
| P596131 | 1/3 | 31,5 x 17 x 16 | 30,10 | 6 |

Suitable for
Compatible con / Adaptable pour



P. 372



P. 373



P. 371



P. 391

Display stands & baskets 14.1

Presentación y expositores
Présentoirs et présentoirs corbeilles

Ba
Bamboo

BUF
FET

NATURAL
FIBERS



Dos posiciones: derecho y revés.
Two positions: right and reverse.
Deux positions: droit et envers
Zwei Positionen: rechts und rückwärts.



P59511 GN buffet bamboo box
Caja GN bambú buffet
Présentoir GN buffet bambou



1/1

| REF | Mod | H cm | € / u | ☐ |
|---------|-----|------|--------|---|
| P595110 | 1/1 | 10 | 86,65 | 1 |
| P595111 | 1/1 | 20 | 110,45 | 1 |

P59512 GN buffet bamboo box
Caja GN bambú buffet
Présentoir GN buffet bambou



1/2

| REF | Mod | H cm | € / u | ☐ |
|---------|-----|------|-------|---|
| P595120 | 1/2 | 10 | 60,40 | 1 |
| P595121 | 1/2 | 20 | 76,15 | 1 |

P59513 GN buffet bamboo box
Caja GN bambú buffet
Présentoir GN buffet bambou

1/3



| REF | Mod | H cm | € / u | ☐ |
|---------|-----|------|-------|---|
| P595130 | 1/3 | 10 | 52,10 | 1 |
| P595131 | 1/3 | 20 | 65,95 | 1 |

P59510 Tray - Lid for GN buffet bamboo box
Bandeja - Tapa para caja GN bambú buffet
Plateau - Couverture pour présentoir GN buffet bambou



| REF | Mod | H cm | € / u | ☐ |
|---------|-----|------|-------|---|
| P595100 | 1/1 | 2 | 50,10 | 1 |
| P595200 | 1/2 | 2 | 33,80 | 1 |
| P595300 | 1/3 | 2 | 31,95 | 1 |

Suitable for
Compatible con / Adaptable pour



P. 371



P. 372



P. 378



P. 397

14.1 Display stands & baskets

Presentación y expositores
Présentoirs et présentoirs corbeilles



P59711 Buffet displayer
Expositor buffet
Présentoir buffet

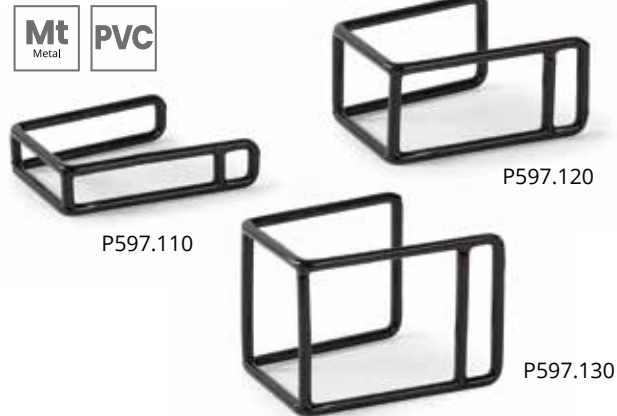

| REF | W x D x H cm | €/u | |
|---------|-----------------|------|---|
| P597110 | 12,5 x 10,5 x 3 | 6,45 | 1 |
| P597120 | 12,5 x 10,5 x 6 | 7,75 | 1 |
| P597130 | 12,5 x 10,5 x 9 | 9,10 | 1 |

19196 Angled Adaptor Plate
Placa adaptadora angular
Plaque intermédiaire inclinée



Elevates pans to enhance food presentation
Eleva las cubetas para mejorar la presentación de los alimentos
Élévage des bacs pour améliorer la présentation des aliments

| REF | W x D x H cm | Type / Tipo | €/u | |
|-------|-----------------|---------------|--------|---|
| 19196 | 53 x 32,5 x 7,0 | 1 GN 1/1 (6°) | 119,30 | 2 |

P597170 Retractable display stand
Expositor buffet extensible
Présentoir buffet rétractable



| REF | Max cm | Min cm | H cm Min / Max | €/u | |
|---------|-----------|-------------|-------------------|-------|---|
| P597170 | 53 x 32,5 | 32,5 x 17,6 | 6,5 / 10 | 58,80 | 1 |

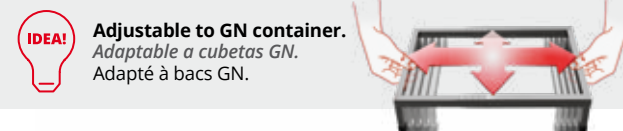

Display stands & baskets 14.1

Presentación y expositores
Présentoirs et présentoirs corbeilles

P59714 Buffet displayer
Expositor buffet
Présentoir buffet

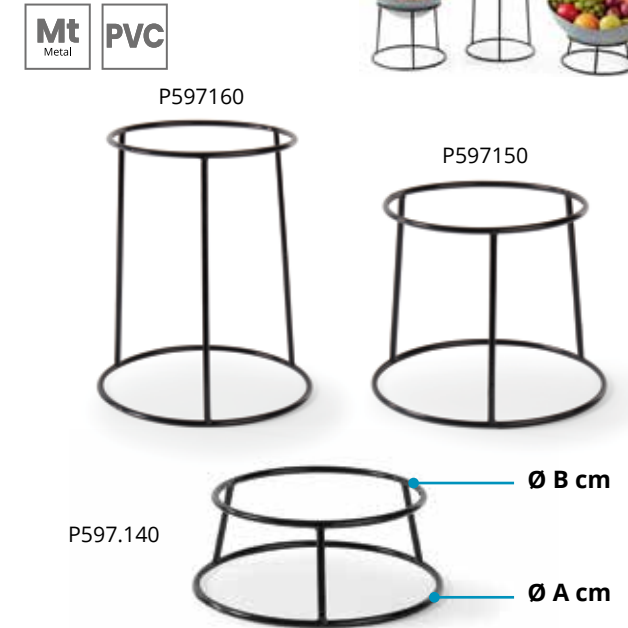

| REF | Ø A cm | Ø B cm | H cm | €/u | |
|---------|--------|--------|------|-------|---|
| P597140 | 25 | 21 | 10 | 13,80 | 1 |
| P597150 | 25 | 21 | 20 | 16,45 | 1 |
| P597160 | 25 | 21 | 30 | 19,10 | 1 |

46009 Set of 3 Square Bent Risers
Juego 3 expositores ángulos redondos
Jeu de 3 socles carrés aux angles arrondis

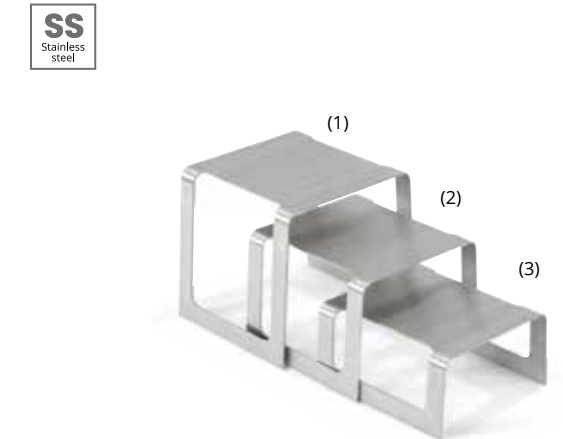

Brushed Stainless Steel
Acero inoxidable pulido
Inox brossé

| REF | W x D x H cm | €/u | |
|-------|--|--------|---|
| 46009 | (1) 20,3 x 20,3 x 20,3 (2) 20,3 x 19,1 x 15,2 (3) 20,3 x 17,8 x 10,2 | 217,80 | 1 |

4600960 Set of 3 Square Bent Risers
Juego 3 expositores ángulos redondos
Jeu de 3 socles carrés aux angles arrondis

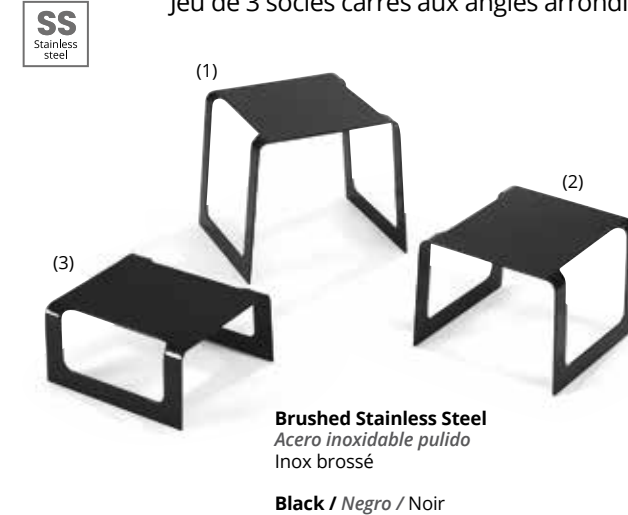

Brushed Stainless Steel
Acero inoxidable pulido
Inox brossé

Black / Negro / Noir

| REF | W x D x H cm | €/u | |
|---------|--|--------|---|
| 4600960 | (1) 20,3 x 20,3 x 20,3 (2) 20,3 x 19,1 x 15,2 (3) 20,3 x 17,8 x 10,2 | 265,60 | 1 |

See products on
Ver productos en / Voir produits en page

Round bowl
Bol redondo
Bol rond

P. 363



Display plate
Soporte presentación
Présentoir



P. 373



14.2 Protection and covers

Protección y tapas
Protection et couvercles

P19060 Mobile and ajustable breath guards Protección Anti-aliento regulable Pare-haleine ajustable



| REF | W x D x H cm | € / u | |
|--------|---------------|--------|---|
| P19060 | 60 x 45 x 38 | 386,70 | 1 |
| P19090 | 90 x 45 x 38 | 476,95 | 1 |
| P19120 | 120 x 45 x 38 | 567,15 | 1 |

Adjustable in tilt and height to adapt to different spaces. Protect exposed foods without losing visibility.

Ajustable en inclinación y altura para adaptarse a diferentes espacios. Protege los alimentos expuestos sin perder visibilidad.

Hauteur et inclinaison réglables pour s'adapter à tous les espaces des buffets. Protège et laisse visible les aliments exposés.

MBA92821 Mobile Acrylic Breath Guards Protección acrílica Anti-aliento Pare-haleine mobiles en acrylique



Bolsa de nylon incluida.
Nylon bag included.
Sac en nylon compris.
Nylontasche nicht enthalten.



| REF | W x D x H cm | € / u | |
|----------|---------------------|--------|---|
| MBA92821 | 121,9 x 49,5 x 40,6 | 925,50 | 1 |

Convenient, durable and portable solution to cover food serving areas. Folds down flat and secures with magnetic latches - for ease in transporting. 1 cm thick acrylic panels can be securely fastened in place with easy thumb turns.

Solución para cubrir superficies de alimentos. Paneles acrílicos de 1 cm de grosor. Duradero. De fácil montaje y transporte.

Solution pratique, durable et portable pour couvrir les zones de service des aliments.

Protection and covers 14.2

Protección y tapas
Protection et couvercles

P590008 Dome cover Tapa campana Couvercle cloche



| REF | Ø cm | H cm | € / u | |
|---------|------|------|-------|---|
| P590008 | 21 | 17,5 | 31,10 | 1 |
| P590009 | 26 | 20,0 | 36,30 | 1 |
| P590010 | 31 | 23,5 | 41,45 | 1 |



Fitting system with the base that provides stability

Sistema de encaje con la base que aporta estabilidad

Système d'assemblage avec la base qui assure la stabilité



P22361 Display tray Bandeja presentación Plateau présentation



| REF | Ø cm | H cm | € / u | |
|--------|------|------|-------|---|
| P22361 | 22,7 | 1,5 | 8,00 | 1 |
| P22362 | 27,8 | 1,5 | 10,15 | 1 |
| P22363 | 32,7 | 1,5 | 14,30 | 1 |

P590011 Hinged cover Tapa con visagra Couvercle articulé



| REF | Ø cm | € / u | |
|---------|------|-------|---|
| P590011 | 23,0 | 15,50 | 1 |
| P590012 | 26,5 | 18,65 | 1 |



IDEA! P590008 + P22361
P590009 + P22362
P590010 + P22363

P2236 Stand Stan Base



Suitable for
Combinable con
Adaptable pour
P22361 / P22362 / P22363

| REF | Ø cm | H cm | € / u | |
|--------|------|------|-------|---|
| P22366 | 16,5 | 10 | 10,30 | 1 |
| P22367 | 16,5 | 18 | 15,35 | 1 |

P22364 Bowl Bol Bol



| REF | Ø cm | € / u | |
|--------|------|-------|---|
| P22364 | 22,5 | 10,35 | 1 |
| P22365 | 26,0 | 17,20 | 1 |



IDEA! P590011 + P22364
P590012 + P22365

14.2 Protection and covers

Protección y tapas
Protection et couvercles



P598700 Clear round lid for presentation
Tapa redonda transparente presentación
Couvercle rond transparent pour présentation



| REF | Ø cm | H cm | €/u | 📦 |
|---------|------|------|-------|---|
| P598700 | 22 | 13,5 | 16,70 | 1 |
| P598800 | 27 | 16,5 | 20,95 | 1 |

P590005 Round display cabinet
Vitrina redonda
Vitrine ronde



| REF | Ø cm | H cm | Base útil Functional basic Base utile Ø cm | €/u | 📦 |
|---------|------|------|---|-------|---|
| P590005 | 38 | 22 | 31,5 | 38,10 | 1 |
| P590006 | 46 | 26 | 37,5 | 53,75 | 1 |

P590001 Rectangular display cabinet
Vitrina rectangular
Vitrine rectangulaire



| REF | W x D x H cm | Base útil Functional basic Base utile Ø cm | €/u | 📦 |
|---------|------------------|---|-------|---|
| P590001 | 40 x 24,5 x 15,5 | 34 x 19 | 49,30 | 1 |
| P590002 | 50,5 x 30,5 x 18 | 44 x 24,5 | 56,15 | 1 |

P590003 Double display cabinet
Vitrina doble
Vitrine double



| REF | W x D x H cm | Base útil Functional basic Base utile Ø cm | €/u | 📦 |
|---------|------------------|---|--------|---|
| P590003 | 40 x 24,5 x 32 | 2 x (34 x 19) | 88,65 | 1 |
| P590004 | 50,5 x 30,5 x 40 | 2 x (44 x 24,5) | 112,20 | 1 |

Protection and covers 14.2

Protección y tapas
Protection et couvercles



P904300 Roll-top lid
Tapa roll-top
Couvercle roll-top

1/1



| REF | Mod | W x D x H cm | €/u | 📦 |
|---------|-----|------------------|-------|---|
| P904300 | 1/1 | 57 x 32,5 x 17,5 | 74,85 | 1 |

P590110 Clear GN lids for presentation
Tapas GN transparentes presentación
Couvercles GN transparentes de présentation



P834 GN prectangular lid
Tapa rectangular GN
Couvercle rectangulaire GN

1/1



| REF | Mod | W x D x H cm | €/u | 📦 |
|---------|-----|----------------|-------|---|
| P834000 | 1/1 | 53 x 32,5 x 10 | 86,65 | 6 |

P835 GN dome lid
Campana GN
Dôme de protection GN

1/1



| REF | Mod | W x D x H cm | €/u | 📦 |
|---------|-----|----------------|-------|---|
| P835000 | 1/1 | 53 x 32,5 x 19 | 82,20 | 6 |

Suitable for
Compatible con / Adaptable pour

P. 391



P. 351



P. 351



P. 378



14.3 Bronze cookware

Batería cocina bronce
Batterie de cuisine bronze

NEW!

Transparent glass lid with stainless steel rim and black handle.

Tapa de cristal transparente con borde de acero inoxidable y mango en color negro.

Couvercle en verre transparent avec rebord en acier inoxydable et manche noir.

Escape valve for steam

Válvula de salida de vapor
Clapet de sortie de la vapeur

Exterior painted in an elegant bronze colour.

Exterior pintado en elegante color bronce.

Extérieur avec revêtement bronze élégant.

Made of cast aluminium with high resistance to deformation and excellent thermal performance.

Fabricada en aluminio de fundición de gran resistencia a la deformación y con excelentes prestaciones térmicas.

Fabriqué en fonte d'aluminium très résistante à la déformation et doté d'excellentes performances techniques.

Ground base

Fondo torneado
Fond dressé

Elegant, robust, versatile

Elegante, robusta, versátil / Élégante, solide, polyvalente



CA
Cast
Aluminium

NEW!



Bronze cookware 14.3

Batería cocina bronce
Batterie de cuisine bronze

P1520 Rotisserie
Rustidera
Plat à rôtir



| REF | W x D x H cm | €/u | ☐ |
|----------|---|-------|---|
| P152035B | 35 x 25 x 7,5 | 79,20 | 1 |
| P152935 | Transparent lid Tapa transparente Couvercle transparent | 20,70 | 1 |

P1410 Shallow casserole without lid
Cazuela baja sin tapa
Cocotte sans couvercle



| REF | Ø cm | H cm | €/u | ☐ |
|----------|------|------|-------|---|
| P141024B | 24 | 5,8 | 43,95 | 1 |
| P141028B | 28 | 7,5 | 56,85 | 1 |
| P141032B | 32 | 8,0 | 67,95 | 1 |

P1510 Deep casserole without lid
Cazuela alta sin tapa
Braising sans couvercle



| REF | Ø cm | H cm | €/u | ☐ |
|----------|------|------|-------|---|
| P151020B | 20 | 9 | 47,60 | 1 |
| P151024B | 24 | 10 | 57,65 | 1 |
| P151028B | 28 | 12 | 67,55 | 1 |

P1540 Glass lid with stainless steel rim
Tapa de cristal con borde de acero inoxidable
Couvercle en verre avec rebord en acier inoxydable

Cr
Crystal



| REF | Ø cm | €/u | ☐ |
|---------|------|-------|---|
| P154020 | 20 | 9,85 | 1 |
| P154024 | 24 | 11,10 | 1 |
| P154028 | 28 | 12,30 | 1 |
| P154032 | 32 | 13,55 | 1 |

14.4 Cool-line

IDEA! Ideal for heated buffets
Ideal para buffet caliente
Idéal pour buffets chauffées

P1311 Enamelled steel GN container
Cubeta GN de acero esmaltado
Bac GN en acier émaillé



Suitable for all types of temperature-maintaining plates.
Apto para todo tipo de placa mantenedora de temperatura.
Convient à tous types de plaques de maintien en température.



NEW!

| REF | Type Tipo | H cm | €/u | ☐ |
|---------|-----------|------|-------|---|
| P131120 | 1/1 | 2,0 | 47,95 | 1 |
| P131165 | 1/1 | 6,5 | 59,95 | 1 |
| P131220 | 1/2 | 2,0 | 37,55 | 1 |
| P131265 | 1/2 | 6,5 | 49,90 | 1 |

P4909 Paella pan with lid
Paellera con tapa
Plat à paella avec couvercle

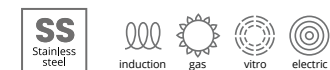

EXCLUSIVE



Ref. colour / Ref. color / Ref. couleur couvercle



| REF | Ø cm | H cm | Lts | €/u | ☐ |
|-----------------|------|------|-----|--------|---|
| P490928 + COLOR | 28 | 6 | 3,7 | 138,60 | 1 |
| P490932 + COLOR | 32 | 6 | 4,7 | 156,85 | 1 |

See products on P. 54
Ver productos en / Voir produits en page

Cookware
Batería de cocina
Batterie de cuisine



See products on P. 71
Ver productos en / Voir produits en page

Fry pans
Sartenes
Poêles



Cool-line 14.4



P1106F3 Non-stick sandwich bottom GN container
Cubeta GN antiadherente con fondo difusor
Bac GN anti-adhésive avec fond thermo-diffuseur

PATENTED EXCLUSIVE



IDEA! Ideal for buffet presentations.
Ideal para presentación buffet.
Idéal pour présentation buffet.

| Ref | Type Tipo | H mm | Lts | €/u | ☐ |
|----------|-----------|------|------|--------|---|
| P1106F3A | 1/1 | 6,5 | 8,30 | 201,75 | 1 |
| P1106F3N | 1/1 | 6,5 | 8,30 | 201,75 | 1 |
| P1106F3R | 1/1 | 6,5 | 8,30 | 201,75 | 1 |
| P1106F3G | 1/1 | 6,5 | 8,30 | 201,75 | 1 |
| P1106F3 | 1/1 | 6,5 | 8,30 | 201,75 | 1 |
| P1206F3A | 1/2 | 6,5 | 4,10 | 132,35 | 1 |
| P1206F3N | 1/2 | 6,5 | 4,10 | 132,35 | 1 |
| P1206F3R | 1/2 | 6,5 | 4,10 | 132,35 | 1 |
| P1206F3G | 1/2 | 6,5 | 4,10 | 132,35 | 1 |
| P1206F3 | 1/2 | 6,5 | 4,10 | 132,35 | 1 |

P1106F3A



P1106F3R



P1106F3



Ref. colour / Ref. color / Ref. couleur couvercle



P1106F3N



P1106F3G



14.5 Super shapes

Buffet presentation steam table pans

Cubetas presentación buffet / Bacs présentation buffet



PATENTED **EXCLUSIVE**

Presentation of food in chafers, heated or refrigerated buffet lines, display cases, and more.

Presentación de las comidas en chafers, líneas buffet calientes o fríos, vitrinas de presentación y más.

Présentation des plats dans les chafers, les lignes de buffet chauffées ou réfrigérées, les présentoirs et bien plus encore.

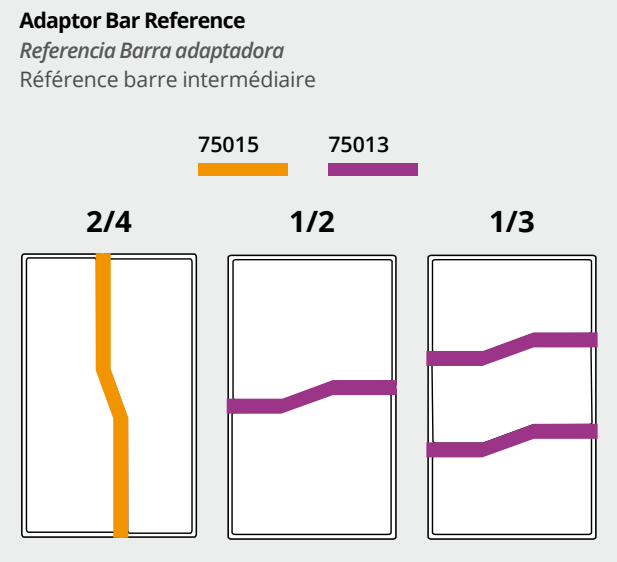

Stackable
Apilable
Empilable



Super shapes 14.5

Buffet presentation steam table pans

Cubetas presentación buffet / Bacs présentation buffet



3101015 Full Oval
Ovalada
Ovale



1/1



| REF | W x D x H cm | L | €/u | u |
|---------|-----------------|-----|-------|---|
| 3101015 | 53 x 32,5 x 5,1 | 3,7 | 70,50 | 6 |
| 3101020 | 53 x 32,5 x 6,5 | 4,6 | 78,10 | 6 |
| 3101040 | 53 x 32,5 x 10 | 7,8 | 93,65 | 6 |

3102015 Half Oval
Óvalo
Ovale



1/2



| REF | cm | L | €/u | u |
|---------|-------------------|-----|-------|---|
| 3102015 | 26,5 x 32,5 x 5,1 | 1,6 | 45,65 | 6 |
| 3102020 | 26,5 x 32,5 x 6,5 | 2,1 | 50,50 | 6 |
| 3102040 | 26,5 x 32,5 x 10 | 3,5 | 61,75 | 6 |

3101220 Full Hexagon
Hexágono
Hexagonal



1/1



| REF | W x D x H cm | L | €/u | u |
|---------|-----------------|-----|-------|---|
| 3101220 | 53 x 32,5 x 6,5 | 5,0 | 69,65 | 6 |
| 3101240 | 53 x 32,5 x 10 | 8,8 | 90,00 | 6 |

3102220 Full Hexagon
Hexágono
Hexagonal



1/2



| REF | W x D x H cm | L | €/u | u |
|---------|-------------------|-----|-------|---|
| 3102220 | 26,5 x 32,5 x 6,5 | 2,1 | 45,30 | 6 |

3101120 Full Kidney
Reniforme
Rein



1/1



| REF | W x D x H cm | L | €/u | u |
|---------|-----------------|-----|-------|---|
| 3101120 | 53 x 32,5 x 6,5 | 4,8 | 70,50 | 6 |

14.5 Super shapes

Buffet presentation steam table pans

Cubetas presentación buffet / Bacs présentation buffet



3102120 Half Kidney
Reniforme
Rein



1/2



| REF | W x D x H cm | L | €/u | 📦 |
|---------|-------------------|-----|-------|---|
| 3102120 | 26,5 x 32,5 x 6,5 | 2,1 | 45,65 | 6 |

3100020 Long Wild Pan
Wild Pan larga
Wild Pan long



2/4



75015

| REF | W x D x H cm | L | €/u | 📦 |
|---------|-----------------|-----|-------|---|
| 3100020 | 53 x 16,5 x 6,5 | 3,5 | 62,95 | 6 |
| 3100040 | 53 x 16,5 x 8,9 | 4,8 | 84,80 | 6 |

3100220 Short Wild Pan
Wild Pan corta
Wild Pan court



1/2



75013

| REF | W x D x H cm | L | €/u | 📦 |
|---------|-------------------|-----|-------|---|
| 3100220 | 26,5 x 32,5 x 6,5 | 3,9 | 62,20 | 6 |
| 3100240 | 26,5 x 32,5 x 10 | 6,1 | 81,60 | 6 |

3100320 Third Outer Wild Pan
Wild Pan externa
Troisième Wild Pan extérieur



1/3



75013

| REF | W x D x H cm | L | €/u | 📦 |
|---------|-------------------|-----|-------|---|
| 3100320 | 17,6 x 32,5 x 6,5 | 2,5 | 44,00 | 6 |
| 3100340 | 17,6 x 32,5 x 10 | 3,6 | 60,05 | 6 |

3100321 Inner Wild Pan
Wild Pan interna
Troisième Wild Pan intérieur



1/3



75013

| REF | W x D x H cm | L | €/u | 📦 |
|---------|-------------------|-----|-------|---|
| 3100321 | 17,6 x 32,5 x 6,5 | 2,5 | 44,00 | 6 |
| 3100341 | 17,6 x 32,5 x 10 | 3,6 | 60,05 | 6 |

75015 Adaptor Bar
Barra adaptadora
Barre intermédiaire



| REF | For / Para / Pour | €/u | 📦 |
|-------|---|-------|----|
| 75015 | 3100020 / 3100040 | 23,30 | 12 |
| 75013 | 3100220 / 3100240 / 3100320 / 3100321 / 3100340 / 3100341 | 22,10 | 12 |

See products on / Ver productos en / Voir produits en page

P. 194

GN St/steel



See products on / Ver productos en / Voir produits en page

P. 203

POLINORM®



BUFFET & ACCESSOIRES
BUFFET / ACCESORIOS
BUFFET / ACCESSOIRES

14.6 Miramar® cookware

Batería de cocina para presentación
Batterie de cuisine-Présentation



Cookware goes straight from the kitchen to your buffet in the same vessel.

Variety of cookware items or any menu.

La batería pasa directamente de la cocina a su buffet en el mismo recipiente.

Variación de utensilios de cocina para todo tipo de comidas.

Passez directement de la cuisine au buffet sans changer de plat.
Variété d'articles pour tout type de menu.



Miramar® cookware 14.6

Batería de cocina para presentación
Batterie de cuisine-Présentation



Satin-finished interior and exterior
Asas y mangos brillantes
Des poignées ultra-brillantes

Handle design serves as a convenient cover rest

Mangos diseñados para la sujeción de las tapas
La conception des manches et poignées sert de reposecouvert

Mirror-finished handles
Interior y exterior satinados
Finition satinée à l'intérieur et l'extérieur

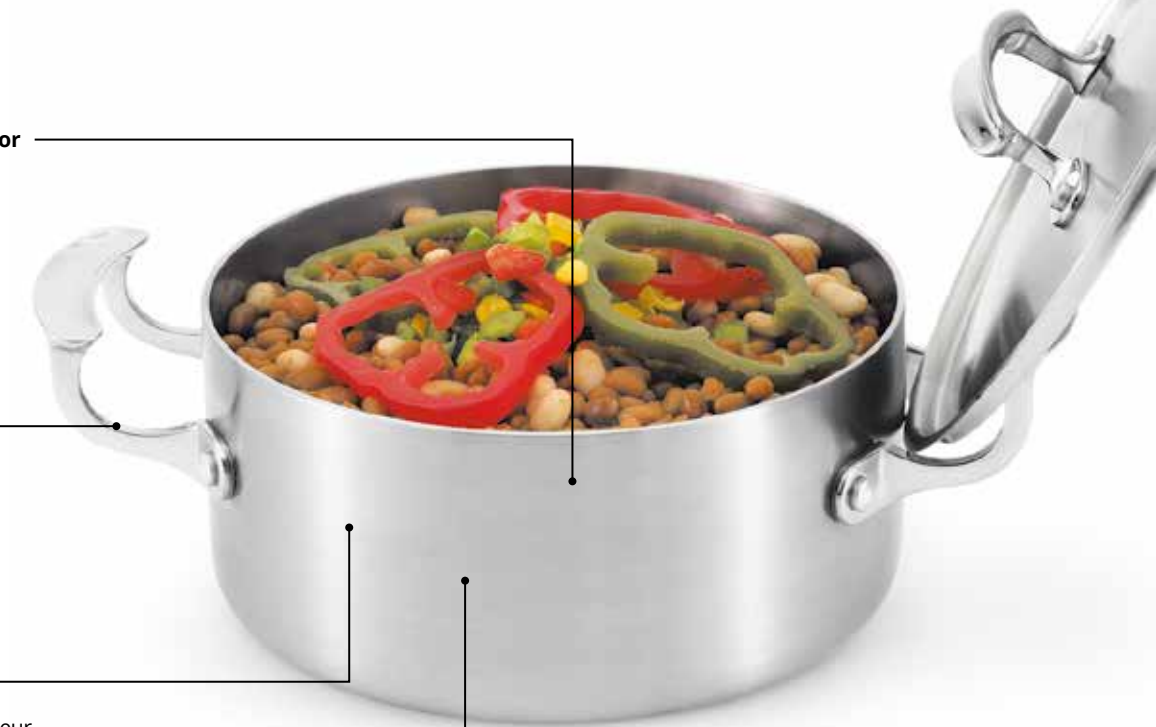

Multi-ply
Multimetal
Multi-metal

St/Steel - Inox

Tri-aluminium

St/Steel - Inox

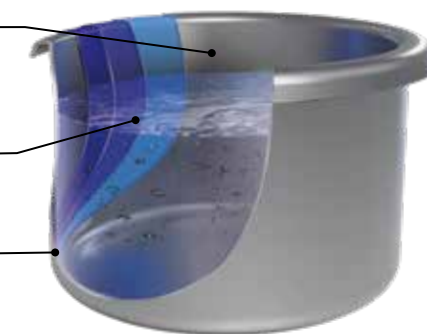

14.6 Miramar® cookware

Batería de cocina para presentación
Batterie de cuisine-Présentation



49410 Casseroles

Cacerola baja con tapa
Faitouts avec couvercle dôme bas



| REF | Ø cm | H cm | L | €/u | 📦 |
|-------|------|------|-----|--------|--------------|
| 49410 | 20,0 | 9,5 | 2,9 | 122,30 | 1 |
| 49411 | 24,1 | 11,3 | 4,8 | 153,70 | 1 |
| 49441 | 25,8 | 18,9 | 6,6 | 211,75 | 1 NEW |

49425 Bazier pan

Cacerola baja
Plat à braiser



| REF | Ø cm | H cm | L | €/u | 📦 |
|-------|------|------|---|--------|---|
| 49425 | 30 | 8,9 | 6 | 136,40 | 1 |

49413 Sauté Pan

Sartén
Sauteuse



| REF | Ø cm | H cm | L | €/u | 📦 |
|-------|------|------|-----|--------|--------------|
| 49416 | 20,3 | 5,1 | 1,2 | 74,65 | 1 NEW |
| 49413 | 26,0 | 4,8 | 2,1 | 107,40 | 1 |

49417 French Omelet Pans

Paellera
Poêle à omelette



| REF | cm | H cm | L | €/u | 📦 |
|-------|-------------|------|-----|--------|---|
| 49417 | 20,3 x 20,3 | 6 | 1,7 | 105,60 | 1 |
| 49424 | 26 x 26 | 6 | 2,9 | 110,60 | 1 |

49418 Stir Fry Pan

Sautex bombeado
Wok/plat de service



| REF | Ø cm | H cm | L | €/u | 📦 |
|-------|------|------|-----|--------|---|
| 49418 | 30,2 | 9,4 | 4,9 | 149,60 | 1 |
| 49428 | 32,1 | 9,2 | 6,0 | 141,05 | 1 |

49430 Sauce Pans

Cazo
Casserole



| REF | Ø cm | H cm | L | €/u | 📦 |
|-------|------|------|-----|-------|--------------|
| 49414 | 15,9 | 9,5 | 1,9 | 96,45 | 1 |
| 49430 | 14,0 | 6,8 | 0,9 | 93,60 | 1 NEW |

Miramar® cookware 14.6

Batería de cocina para presentación
Batterie de cuisine-Présentation



49432 Food Pans

Fuente
Plat



| REF | W x D x H cm | L | €/u | 📦 |
|-------|-------------------|-----|--------|--------------|
| 49432 | 37,3 x 30 x 5,1 | 4,4 | 146,45 | 1 NEW |
| 49435 | 29,1 x 23,6 x 5,1 | 2,6 | 145,25 | 1 |
| 49433 | 37,3 x 30 x 5,1 | 4,4 | 168,50 | 1 |

49431 French Oven with cover

Fuente Horno con tapa
Cocotte avec couvercle



| REF | W x D x H cm | L | €/u | 📦 |
|-------|-----------------|-----|--------|---|
| 49431 | 363 x 282 x 9,7 | 6,6 | 252,55 | 1 |

8230210 Oval presentation dish

Fuente presentación ovalada
Fontaine de présentation ovale



| REF | W x D x H cm | L | €/u | 📦 |
|---------|-------------------|-----|--------|---|
| 8230210 | 33,3 x 22,5 x 6,4 | 1,9 | 121,25 | 1 |
| 8231420 | 48,4 x 30,2 x 5,1 | 2,8 | 160,40 | 1 |

49420 Oval Au Gratin

Fuente para gratinar
Plat à gratin ovale



* Mirror-finished interior
Acabado brillante
Ultra-brillante

| REF | W x D x H cm | L | €/u | 📦 |
|--------|--------------------|-----|--------|--------------|
| 49420 | 25,4 x 19,1 x 5,2 | 1,7 | 112,15 | 1 |
| 49412* | 30,5 x 21,6 x 5,1 | 2,5 | 116,15 | 1 |
| 49442 | 40,6 x 22,9 x 5,1 | 3,5 | 208,00 | 1 NEW |
| 49445 | 52,3 x 22,9 x 10,2 | 6,6 | 259,00 | 1 NEW |

49429 Covers

Tapa
Couvercles



| REF | For / Para / Pour | Ø cm | H mm | €/u | 📦 |
|-------|-------------------|------|------|-------|--------------|
| 49429 | 49428 | 35,6 | 120 | 63,60 | 1 |
| 49426 | 49418 - 49425 | 32,4 | 102 | 58,55 | 1 |
| 49419 | 49416 - 49417 | 20,3 | 51 | 36,15 | 1 |
| 49423 | 49413 - 49424 | 27,3 | 51 | 39,70 | 1 |
| 49427 | 49430 | 14,9 | 51 | 25,65 | 1 NEW |

8231810 Rectangular presentation dish

Fuente presentación rectangular
Fontaine de présentation rectangulaire



| REF | W x D x H cm | L | €/u | 📦 |
|---------|-----------------|-----|--------|---|
| 8231810 | 33,2 x 27 x 2,5 | 1,5 | 96,85 | 1 |
| 8230720 | 33,2 x 27 x 7 | 3,2 | 129,00 | 1 |

14.6 Miramar® cookware

Batería de cocina para presentación
Batterie de cuisine-Présentation

TEMPLATES PLANTILLAS GABARITS

Stainless Steel Plain / Acero inox. / Inox
Resin / Resina / Résine
Night Sky / Negro / Bleu nuit

+150°C



8242014 One large and one small round
Plantilla agujeros redondo grande y pequeño
Une grande découpe ronde et une petite découpe ronde



| REF | cm | €/u | 1 |
|---------|-------------|--------|---|
| 8242014 | 53,6 x 32,4 | 235,55 | 1 |
| 8242010 | 53,6 x 32,4 | 189,00 | 1 |

8242314 One large oval
Plantilla agujero oval grande
Une grande découpe ovale



| REF | cm | €/u | 1 |
|---------|-------------|--------|---|
| 8242314 | 53,6 x 32,4 | 235,55 | 1 |
| 8242310 | 53,6 x 32,4 | 189,00 | 1 |

8242414 One large round and one small round
Plantilla agujeros redondo grande y pequeño
Une grande découpe ronde et une petite découpe ronde



| REF | cm | €/u | 1 |
|---------|-------------|--------|---|
| 8242414 | 53,6 x 32,4 | 235,55 | 1 |

8242514 Two large round
Plantilla agujeros redondos grandes
2 grandes découpes rondes



| REF | cm | €/u | 1 |
|---------|-------------|--------|---|
| 8242514 | 53,6 x 32,4 | 235,55 | 1 |

8242614 One large round
Plantilla agujero redondo grande
Une grande découpe ronde

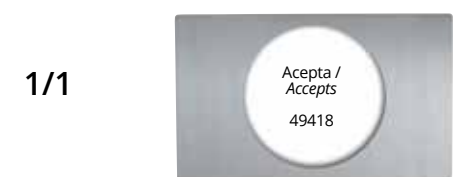

| REF | cm | €/u | 1 |
|---------|-------------|--------|---|
| 8242614 | 53,6 x 32,4 | 235,55 | 1 |
| 8242610 | 53,6 x 32,4 | 189,00 | 1 |

8242714 One large oval
Plantilla agujero oval grande
Un grand ovale



| REF | cm | €/u | 1 |
|---------|-------------|--------|---|
| 8242714 | 53,6 x 32,4 | 235,55 | 1 |
| 8242710 | 53,6 x 32,4 | 189,00 | 1 |

Miramar® cookware 14.6

Batería de cocina para presentación
Batterie de cuisine-Présentation

+150°C

8240016 Solid baseplate
Plantilla sólida
Modèle solide



1/1



| REF | cm | €/u | 1 |
|---------|-------------|--------|---|
| 8240016 | 53,6 x 32,4 | 235,55 | 1 |

8242814 One small food pan
Plantilla para fuente
Un petit bac à aliments



| REF | cm | €/u | 1 |
|---------|-------------|--------|---|
| 8242814 | 53,6 x 32,4 | 235,55 | 1 |
| 8242810 | 53,6 x 32,4 | 189,00 | 1 |

8242914 One large food pan
Plantilla para fuente
Un grand bac à aliments

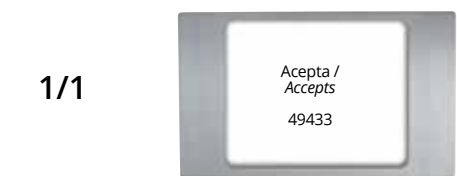

| REF | cm | €/u | 1 |
|---------|-------------|--------|---|
| 8242914 | 53,6 x 32,4 | 235,55 | 1 |

8243014 Two small food pans
Plantilla para fuente
Deux petits bacs à aliments



| REF | cm | €/u | 1 |
|---------|-------------|--------|---|
| 8243014 | 53,6 x 32,4 | 235,55 | 1 |

8243114 One large and one medium oval
Plantilla agujeros ovales grande y pequeño
Une grande découpe ronde et une moyenne découpe ovale



| REF | cm | €/u | 1 |
|---------|-------------|--------|---|
| 8243114 | 53,6 x 32,4 | 235,55 | 1 |

8243214 Two medium oval
Plantilla agujeros redondos medianos
Deux découpes ovales moyennes



| REF | cm | €/u | 1 |
|---------|-------------|--------|---|
| 8243214 | 53,6 x 32,4 | 235,55 | 1 |
| 8243210 | 53,6 x 32,4 | 189,00 | 1 |

8243314 One large and one medium round
Plantilla agujeros redondos grande y mediano
Une grande découpe ronde et une moyenne découpe ronde



| REF | cm | €/u | 1 |
|---------|-------------|--------|---|
| 8243314 | 53,6 x 32,4 | 235,55 | 1 |

14.7 CUBIC®

EXCLUSIVE

PATENT PENDING

Modularity that reflects maximum expression

Modularidad a la máxima expresión

Modularité à son expression maximale



Discover the best buffet display, thanks to its:

- It allows to optimize exhibition space
- It reduces assembly and disassembly time
- Ease of transport and storage
- Elegant and original
- It offers multiple and varied combinations

Descubre la mejor presentación de buffet, porque:

- Permite optimizar espacio de exposición
- Reduce el tiempo de montaje y desmontaje
- Facilidad de transporte y almacenaje
- Elegante y original
- Ofrece múltiples y variadas combinaciones

Découvrez la meilleure présentation buffet, grâce à son :

- Permet d'optimiser l'espace d'exposition
- Réduit le temps de montage et de démontage
- Facilité de transport et de stockage
- Élégant et original
- Offre des combinaisons multiples et variées



CUBES / CUBO / CUBES

Top cover convertible on mini shelf, stackable, multicombinations, saving space when storing parts, special waterproof treatment.

Con tapa superior transformable en mini estante, apilables entre sí, múltiples combinaciones posibles, ahorro de espacio durante el almacenaje de las piezas, tratamiento hidrófugo especial.

Couvercle transformable en mini rayon, empilables, multiples combinaisons possibles, gain d'espace pour le stockage des composants, traitement hydrofuge spécial.

SHELVES / ESTANTES / TABLETTES

Three lengths: 50, 80 and 100 cm, two depths: 18 and 35 cm, undeformable wood. Special waterproof treatment.

Tres longitudes: 50, 80 y 100 cm, dos profundidades: 18 y 35 cm, madera indeformable. Tratamiento hidrófugo especial.

Trois longueurs: 50, 80 et 100 cm, deux profondeurs: 18 et 35 cm. Bois indéformable. Traitement hydrofuge spécial.

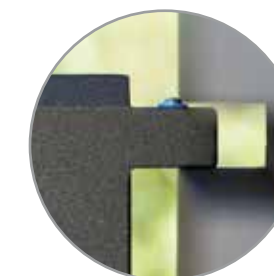
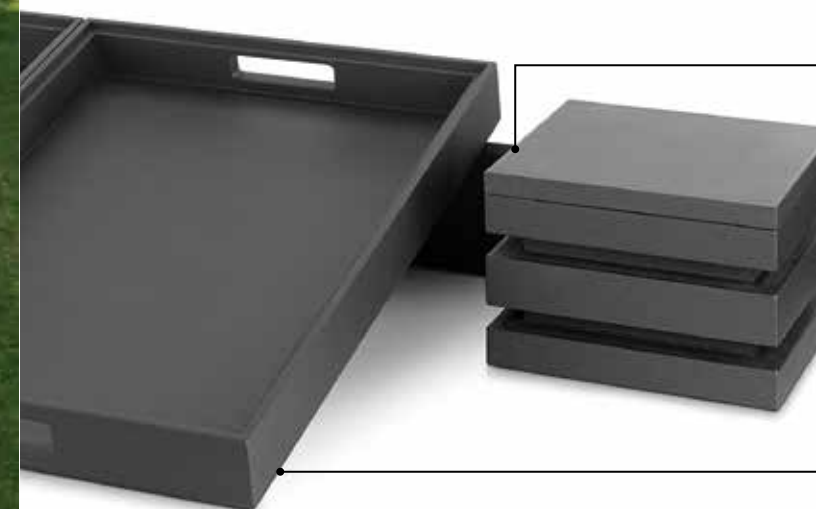

Stackable trays
Bandejas apilables entre sí
Plateaux empilables entre eux

Display buffet cases Muebles presentación buffet Meubles présentation buffet

Suitable for gastronorm sizes
Adaptado a medidas gastronorm
Adaptés aux mesures gastronorme

Made of wood with special waterproof treatment, easy to clean

Fabricados en madera con tratamiento hidrófugo especial, de fácil limpieza

Fabriqué en bois avec un traitement hydrofuge spécial, facile à nettoyer



Wooden buffet serving trolley Carro madera presentación buffet Chariot buffet en bois présentation buffet

Outstanding combination of wood and aluminium
Elegante combinación de madera y aluminio
Combinaison élégante en bois et en aluminium

Suitable for gastronorm sizes
Adaptado a medidas gastronorm
Adaptés aux mesures gastronorme

Possible transformation from an expositor trolley to a presentation table

Posibilidad de convertir el carro expositor en mesa de presentación

Possibilité de transformer le chariot d'exposition en une table de présentation

Wood with special waterproof treatment, easy to clean
Tratamiento hidrófugo especial, de fácil limpieza
Bois avec un traitement hydrofuge spécial, facile à nettoyer



P905504 Presentation kit for 4 square bowls Conjunto soporte 4 bols cuadrados Kit support 4 bols carrés

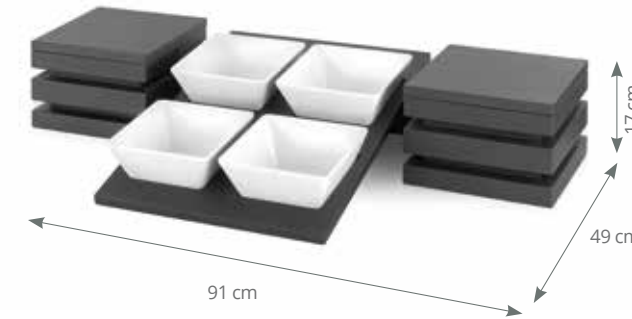

Includes :
2 cubes with lid
1 crossbar 50 cm length
1 displayer for 4 bowls
4 melamine bowls.

Incluye:
2 cubos con tapa
1 travesaño de 50 cm
1 presentador de 4 bols
4 bols de melamina.

Inclus :
2 cubes avec couvercle
1 longeron 50 cm
1 présentoir pour 4 bols
4 bols mélamine.

| REF | €/u | |
|---------|--------|---|
| P905504 | 398,65 | 1 |

P905506 Presentation kit for 6 square bowls Conjunto soporte 6 bols cuadrados Kit support 6 bols carrés

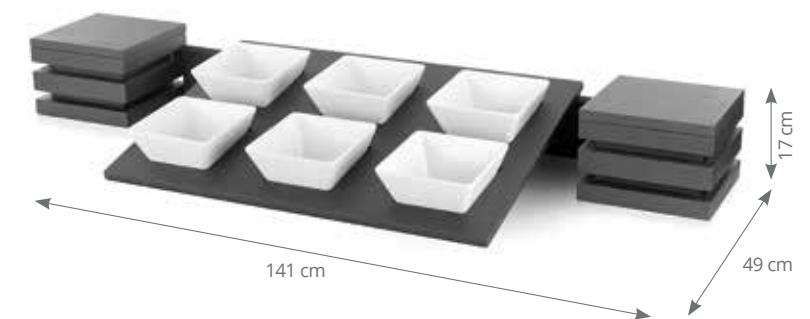

Includes :
2 cubes with lid
1 crossbar 100 cm length
1 displayer for 6 bowls
6 melamine bowls.

Incluye:
2 cubos con tapa
1 travesaño de 100 cm
1 presentador de 6 bols
6 bols de melamina.

Inclus :
2 cubes avec couvercle
1 longeron 100 cm
1 présentoir pour 6 bols
6 bols mélamine.

| REF | €/u | |
|---------|--------|---|
| P905506 | 434,85 | 1 |

P905516 Two levels presentation kit for 6 square bowls Conjunto 2 niveles soporte 6 bols Kit support 6 bols carrés deux niveaux

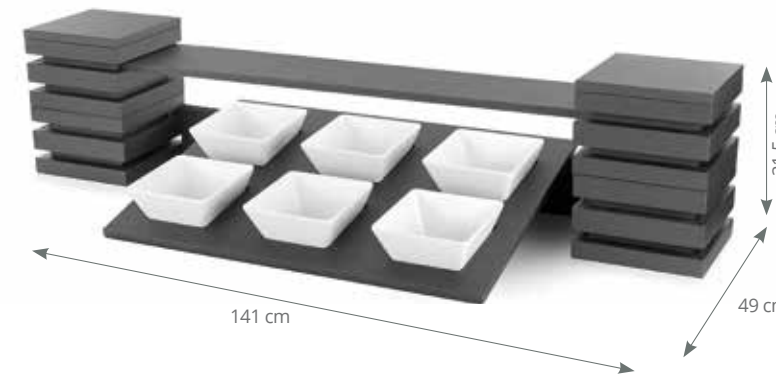

Includes :
4 cubes with lid
1 crossbar 100 cm length
1 displayer for 6 bowls
6 melamine bowls
1 narrow shelf 100 cm

Incluye:
4 cubos con tapa
1 travesaño de 100 cm
1 presentador de 6 bols
6 bols de melamina
1 estante estrecho de 100 cm

Inclus :
4 cubes avec couvercle
1 longeron 100 cm
1 présentoir pour 6 bols
6 bols mélamine
1 tablette étroite 100 cm

| REF | €/u | |
|---------|--------|---|
| P905516 | 711,95 | 1 |

P905508 Presentation kit for 8 square bowls Conjunto soporte 8 bols cuadrados Kit support 8 bols carrés



Includes :
2 cubes with lid
1 crossbar 80 cm length
2 displayers for 4 bowls
8 melamine bowls

Incluye:
2 cubos con tapa
1 travesaño de 80 cm
2 presentadores de 4 bols
8 bols de melamina

Inclus :
2 cubes avec couvercle
1 longeron 80 cm
2 présentoirs pour 4 bols
8 bols mélamine

| REF | €/u | |
|---------|--------|---|
| P905508 | 452,10 | 1 |

P905518 Two levels presentation kit for 8 square bowls

Conjunto 2 niveles soporte 8 bols
Kit support 8 bols carrés deux niveaux

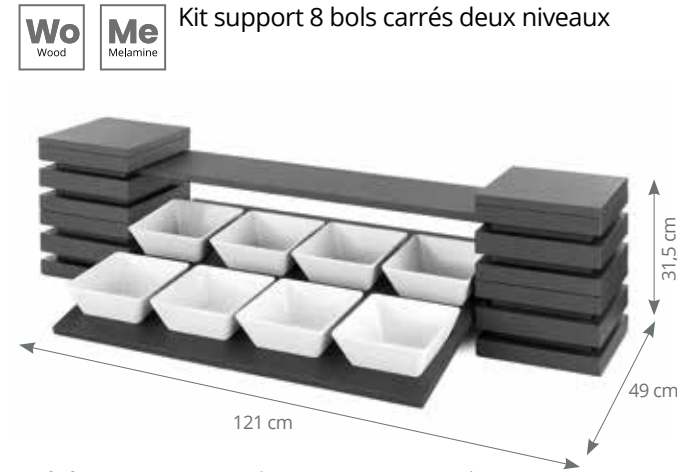

Includes:
4 cubes with lid
1 crossbar 80 cm length
2 displays for 4 bowls
8 melamine bowls
1 narrow shelf 80 cm

Incluye:
4 cubos con tapa
1 travesaño 80 cm
2 presentadores de 4 bols
8 bols de melamina
1 estante estrecho 80 cm

Inclus:
4 cubes avec couvercle
1 longeron 80 cm
2 présentoirs pour 4 bols
8 bols mélamine
1 tablette étroite 80 cm

| REF | €/u | |
|---------|--------|---|
| P905518 | 713,10 | 1 |

P905400 Basic two levels presentation kit

Conjunto básico estante 2 niveles

Kit basique présentation 2 niveaux



Includes:
4 cubes with lid
1 wide shelf 100 cm
1 narrow shelf 100 cm

Incluye:
4 cubos con tapa
1 estante ancho 100 cm
1 estante estrecho 100 cm

Inclus:
4 cubes avec couvercle
1 tablette large 100 cm
1 tablette étroite 100 cm

| REF | €/u | |
|---------|--------|---|
| P905400 | 570,95 | 1 |

P905310 Two levels presentation kit for 40x40 cm trays

Conjunto 2 niveles bandejas 40x40 cm
Kit présentation 2 niveaux pour plateaux 40x40 cm

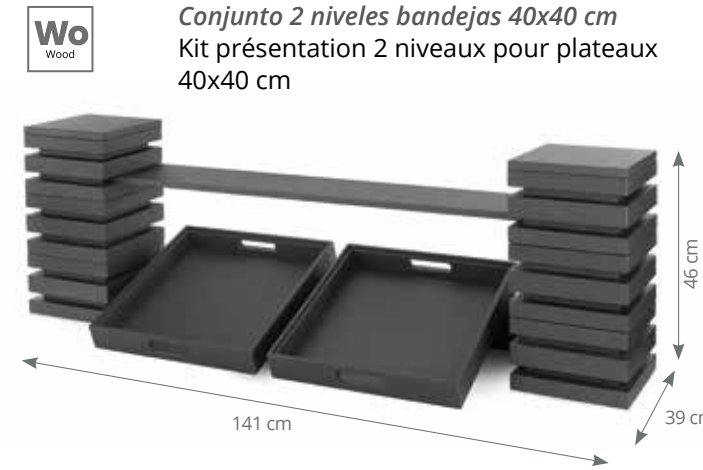

Includes:
6 cubes with lid
1 crossbar 100 cm length
2 serving trays 40 x 40 cm
1 narrow shelf 100 cm

Incluye:
6 cubos con tapa
1 travesaño de 100 cm
2 bandejas presentación de 40 x 40 cm
1 estante estrecho de 100 cm

Inclus:
6 cubes avec couvercle
1 longeron 100 cm
2 plateaux présentation 40 x 40 cm
1 tablette étroite 100 cm

| REF | €/u | |
|---------|--------|---|
| P905310 | 949,85 | 1 |

P905320 Two trays 60x40 cm presentation kit

Conjunto 2 bandejas 60x40 cm
Kit présentation pour deux plateaux 60x40 cm

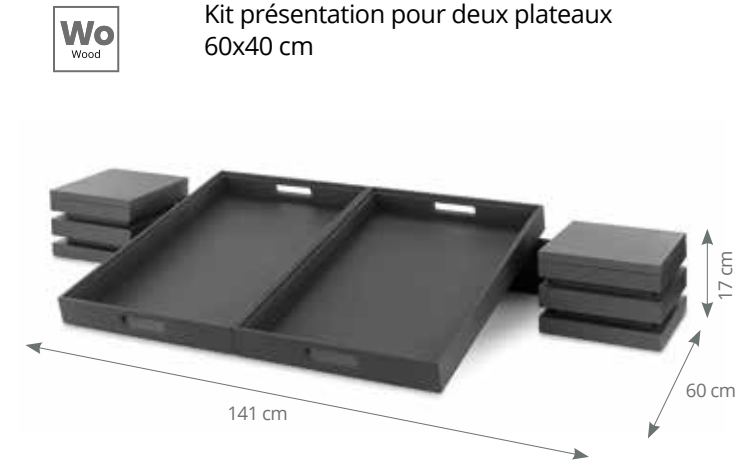

Includes:
2 cubes with lid
1 crossbar 100 cm length
2 serving trays 60 x 40 cm

Incluye:
2 cubos con tapa
1 travesaño de 100 cm
2 bandejas presentación de 60 x 40 cm

Inclus:
2 cubes avec couvercle
1 longeron 100 cm
2 plateaux présentation 60 x 40 cm

| REF | €/u | |
|---------|--------|---|
| P905320 | 493,80 | 1 |

P905410 "L" shape two levels presentation kit

Conjunto estante dos niveles forma "L"
Kit présentation "L" 2 niveaux

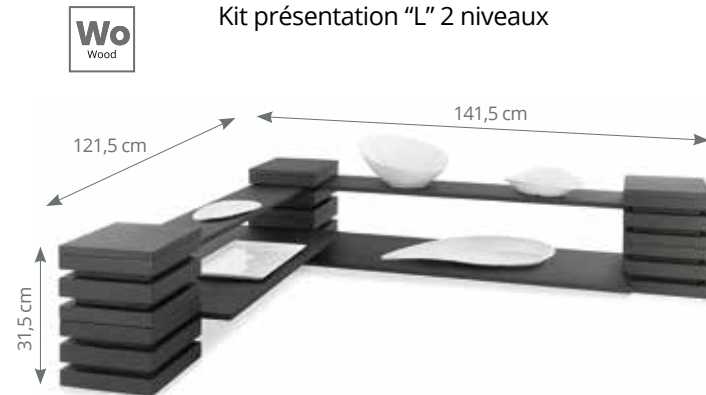

Includes:
6 cubes with lid
1 wide shelf 100 cm
1 narrow shelf 100 cm
1 wide shelf 80 cm
1 narrow shelf 80 cm

Incluye:
6 cubos con tapa
1 estante ancho 100 cm
1 estante estrecho 100 cm
1 estante ancho 80 cm
1 estante estrecho 80 cm

Inclus:
6 cubes avec couvercle
1 tablette large 100 cm
1 tablette étroite 100 cm
1 tablette large 80 cm
1 tablette étroite 80 cm

| REF | €/u | |
|---------|--------|---|
| P905410 | 904,05 | 1 |

P905300 Two trays 40x40 cm presentation kit

Conjunto 2 bandejas presentación 40x40 cm
Kit présentation pour deux plateaux 40x40 cm

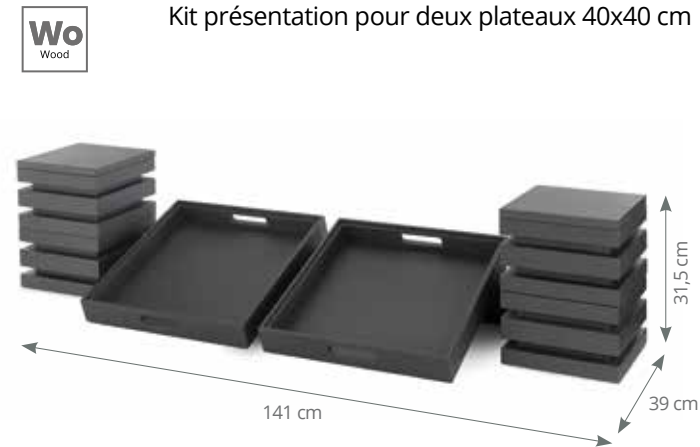

Includes:
4 cubes with lid
1 crossbar 100 cm length
2 serving trays 40 x 40 cm

Incluye:
4 cubos con tapa
1 travesaño de 100 cm
2 bandejas presentación de 40 x 40 cm

Inclus:
4 cubes avec couvercle
1 longeron 100 cm
2 plateaux présentation 40 x 40 cm

| REF | €/u | |
|---------|--------|---|
| P905300 | 684,05 | 1 |

P905340 Two levels for trays 60x40 cm presentation kit

Conjunto 2 niveles para bandejas 60x40 cm
Kit présentation 2 niveaux pour plateaux 60x40 cm

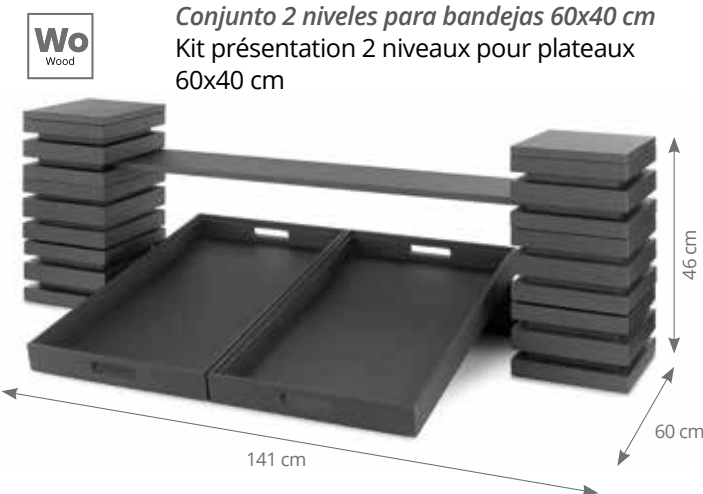

Includes:
6 cubes with tapa
1 travesaño de 100 cm
2 bandejas presentación de 60 x 40 cm
1 estante estrecho de 100 cm

Incluye:
6 cubos con tapa
1 travesaño de 100 cm
2 bandejas presentación de 60 x 40 cm
1 estante estrecho de 100 cm

Inclus:
6 cubes avec couvercle
1 longeron 100 cm
2 plateaux présentation 60 x 40 cm
1 tablette étroite 100 cm

| REF | €/u | |
|---------|--------|---|
| P905340 | 981,25 | 1 |

P904790 Three levels 2/3 GN stand

Expositor GN 2/3, tres niveles
Présentoir 3 niveaux pour GN 2/3



Includes / Incluye / Inclus:
3 GN containers 2/3 20 mm
3 cubetas GN 2/3 20 mm
3 bags GN 2/3 20 mm

| REF | W x D x H cm | €/u | |
|---------|--------------|--------|---|
| P904790 | 65 x 38 x 59 | 261,85 | 1 |

P904350 GN skewer serving tray
Bandeja GN presentación pinchos
Plateau GN présentation piques



GN 1/1

Includes:
wooden tray
oak melamine tray
interior skewer stand

Incluye:
bandeja madera
bandeja melamina roble
soporte interior pinchos

Inclus:
plateau bois
plateau mélamine chêne
support intérieur piques

| REF | W x D x H cm | Holes Agujeros Ø cm | Piques Pinchos | €/u | |
|---------|-------------------|------------------------|-------------------|--------|---|
| P904350 | 53,9 x 33,5 x 7,7 | 0,4 | 84 | 266,05 | 1 |

P904155 Buffet wine cooler
Enfriador botellas buffet
Rafráichisseur bouteilles



GN 1/1

Includes:
wooden tray
1/1 GN pan 150 mm

Incluye:
bandeja madera
cubeta GN 1/1 150 mm

Inclus:
plateau bois
bac GN 1/1 150 mm

| REF | W x D x H cm | €/u | |
|---------|----------------|--------|---|
| P904155 | 57 x 37 x 14,5 | 175,30 | 1 |

P904850 1/1 GN wooden table + cutting board
Mesita buffet GN 1/1 + taco madera
Table GN 1/1 en bois + planche à découper



| REF | W x D x H cm | €/u | |
|---------|----------------|--------|---|
| P904850 | 53 x 32,5 x 12 | 165,40 | 1 |

P904810 Low wooden table + cutting board
Mesita buffet baja + taco madera
Table basse en bois + planche à découper



| REF | W x D x H cm | €/u | |
|---------|------------------|--------|---|
| P904810 | 32,5 x 22 x 12 | 130,35 | 1 |
| P904820 | 32,5 x 22 x 16,5 | 145,10 | 1 |

P904804 Cutting board for wooden table
Taco madera para mesita buffet
Planche à découper pour table en bois



P904804

P904809

| REF | W x D x H cm | €/u | |
|----------------------|------------------|-------|---|
| P904804 ¹ | 29,2 x 18,7 x 22 | 38,70 | 1 |
| P904809 ² | 49,7 x 29,2 x 22 | 52,30 | 1 |

(1) For / Para / Pour P904810 / P904820
(2) For / Para / Pour P904850

P904720 Napkin and tea & sugar bags dispenser
Servilletero y dispensador bolsas te y azúcar
Distributeur serviettes et des saquettes
thé & sucre



P904720

P904725

| REF | W x D x H cm | €/u | |
|---------|---------------|-------|---|
| P904720 | 22 x 22 x 5,5 | 55,60 | 1 |
| P904725 | 22 x 22 x 5,5 | 83,25 | 1 |

P904721 Tea & sugar bag holder
Soporte bolsas te y azúcar
Support pour saquettes de thé & sucre



For / Para / Pour ref. P904.720

| REF | W x D x H cm | €/u | |
|---------|-------------------|-------|---|
| P904721 | 19,8 x 19,8 x 4,9 | 32,20 | 1 |

P20072 Methacrylate holder
Portamenús metacrilato
Porte-menus méthacrylate



| REF | cm | €/u | |
|--------|-------|------|---|
| P20072 | 6 x 6 | 7,75 | 1 |



See products on / Ver productos en / Voir produits en page

P. 485

Stainless steel plate covers
Tapas Acero inoxidable para platos
Inox couvercles à assiette





ROOM SERVICE

P904780 Cutlery-holder tray
Bandeja porta-cubiertos
Plateau porte-couverters



GN 1/1



Stackables.
Apilables.
Empilables.

4 compartments
4 compartimentos
4 compartiments
303 x 115 mm

| REF | W x D x H cm | € / u | |
|---------|-------------------|--------|---|
| P904780 | 53,9 x 33,5 x 7,7 | 147,00 | 1 |

P904760 Serving tray
Bandeja servicio y presentación
Plateau service et présentation



Stackables.
Apilables.
Empilables.

IDEA! Room service tray.
Perfecta para servicio de habitaciones.
Plateau idéal pour service de chambre.

| REF | W x D x H cm | € / u | |
|---------|---------------|--------|---|
| P904760 | 60 x 40 x 6,5 | 124,95 | 1 |

P904740 Serving tray
Bandeja presentación
Plateau présentation



Stackables.
Apilables.
Empilables.

| REF | W x D x H cm | € / u | |
|---------|---------------|--------|---|
| P904740 | 40 x 40 x 6,5 | 101,85 | 1 |

P904711 1/1 GN serving tray
Bandeja servicio y presentación GN 1/1
Plateau service et présentation GN 1/1



GN 1/1

Stackables.
Apilables.
Empilables.

1/1 Gastronorm container not included.
No incluye cubeta gastronorm 1/1.
Bac gastronorme 1/1 non inclus.

| REF | W x D x H cm | € / u | |
|---------|-------------------|--------|---|
| P904711 | 53,9 x 33,5 x 7,7 | 110,80 | 1 |

P904600 Wooden cube with lid
Cubo con tapa madera
Cube en bois avec couvercle

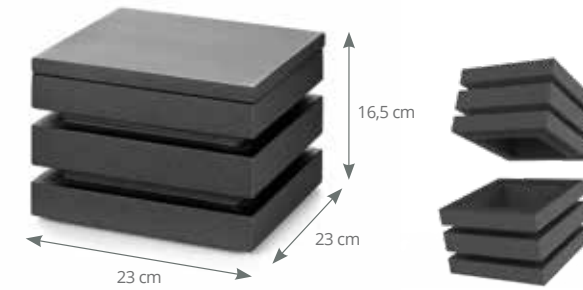

| REF | € / u | |
|---------|--------|---|
| P904600 | 120,35 | 1 |

P904650 Wooden narrow shelf
Estante madera estrecho
Tablette en bois étroite

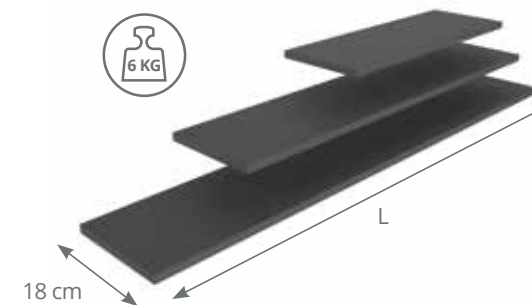

| REF | L cm | € / u | |
|---------|------|-------|---|
| P904650 | 50 | 41,05 | 1 |
| P904680 | 80 | 50,25 | 1 |
| P904610 | 100 | 51,90 | 1 |

P904937 Displayer for 4 melamine bowls
Presentador 4 bols melamina cuadrados
Présentoir 4 bols mélamine

For square bowls
Para bols cuadrados
Pour bols carrés
180 x 180
REF. P22.202



| REF | W x D x H cm | € / u | |
|---------|-----------------|-------|---|
| P904937 | 37,5 x 50 x 1,5 | 85,15 | 1 |

P904950 Crossbar buffet trays
Travesaño soporte bandejas
Longerons pour plateaux buffet



P904660 Wooden lid
Tapa madera
Couvercle en bois



| REF | € / u | |
|---------|-------|---|
| P904660 | 19,75 | 1 |

P904652 Wooden wide shelf
Estante madera ancho
Tablette en bois large

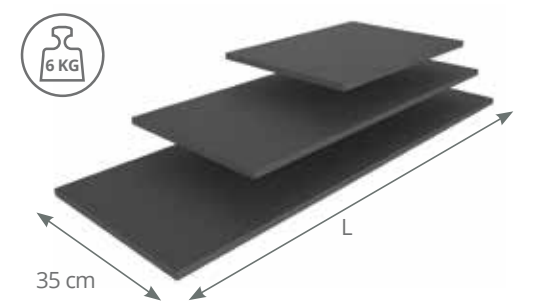

| REF | L cm | € / u | |
|---------|------|-------|---|
| P904652 | 50 | 68,70 | 1 |
| P904682 | 80 | 89,15 | 1 |
| P904612 | 100 | 92,10 | 1 |

P904975 Displayer for 6 melamine bowls
Presentador 6 bols melamina cuadrados
Présentoir 6 bols mélamine

For square bowls
Para bols cuadrados
Pour bols carrés
180 x 180
REF. P22.202



| REF | W x D x H cm | € / u | |
|---------|---------------|--------|---|
| P904975 | 75 x 50 x 1,5 | 100,30 | 1 |

| REF | W x D x H cm | € / u | |
|---------|----------------|-------|---|
| P904950 | 50 x 12,4 x 2 | 62,30 | 1 |
| P904980 | 80 x 12,4 x 2 | 68,20 | 1 |
| P904990 | 100 x 12,4 x 2 | 72,85 | 1 |

P904165 Perforated buffet display
Buffet perforado
Buffet perforé



Includes:
Wooden frame perforated 1/1 GN pan 65 mm gastronorm pan 1/1 20 mm roll-top lid.

Incluye:
Marco madera bandeja perforada GN 1/1 65 mm cubeta GN 1/1 20 mm cúpula roll-top

Inclus:
Cadre en bois bac GN 1/1 65 mm perforé bac GN 1/1 20 mm couvercle roll-top

| REF | W x D x H cm | € / u | |
|---------|--------------|--------|---|
| P904165 | 57 x 37 x 31 | 258,10 | 1 |

P904113 Triple buffet display
Buffet triple
Buffet triple



Includes:
Wooden frame 3 units 1/3 GN pans 65 mm GN pan 1/1 20 mm roll-top lid.

Incluye:
Marco madera 3 cubetas GN 1/3 65 mm cubeta GN 1/1 20 mm cúpula roll-top.

Inclus:
Cadre en bois 3 bacs GN 1/3 65 mm bac GN 1/1 20 mm couvercle roll-top.

| REF | W x D x H cm | € / u | |
|---------|--------------|--------|---|
| P904113 | 57 x 37 x 31 | 257,25 | 1 |

P904200 Wooden frame
Marco madera
Cadre en bois



P904.200

P904120 Standard buffet display
Buffet estandar
Buffet standard



Includes:
Wooden frame 2u. 1/1 GN 1/1 20 mm roll-top lid

Incluye:
Marco madera 2 u. cubeta GN 1/1 20 mm cúpula roll-top

Inclus:
Cadre en bois 2 u. bacs GN 1/1 20 mm couvercle roll-top

| REF | W x D x H cm | € / u | |
|---------|--------------|--------|---|
| P904120 | 57 x 37 x 31 | 243,30 | 1 |

P904140 Cheese buffet display
Buffet quesos
Buffet fromage



Includes:
Wooden frame wooden cutting board GN pan 1/1 20 mm roll-top lid.

Incluye:
Marco madera bandeja corte madera cubeta GN 1/1 20 mm cúpula roll-top.

Inclus:
Cadre en bois planque à découper en bois bac GN 1/1 20 mm couvercle roll-top.

| REF | W x D x H cm | € / u | |
|---------|--------------|--------|---|
| P904140 | 57 x 37 x 31 | 287,00 | 1 |

| REF | W x D x H cm | € / u | |
|---------|----------------|--------|---|
| P904200 | 57 x 37 x 14,5 | 128,05 | 1 |

P904400 Isothermal mat
Tapete isotérmico
Tapis isotherme



| REF | W x D x H cm | € / u | |
|---------|--------------|-------|-----|
| P904400 | 47 x 26 x 20 | 11,75 | 250 |

P904160 Melamine slate buffet displayer
Buffet pizarra melamina
Mélamine buffet ardoise



Includes:
Wooden frame melamine slate board 1/1 GN container 20 mm

Incluye:
Marco madera tabla pizarra melamina cubeta GN 1/1 20 mm

Inclus:
Cadre en bois plaque ardoise en mélamine bac GN 1/1 20 mm

| REF | W x D x H cm | € / u | |
|---------|----------------|--------|---|
| P904160 | 57 x 37 x 14,5 | 207,50 | 1 |

P904146 Wooden bread cutting board
Cortador pan madera
Plaque à découper pain en bois



| REF | W x D x H cm | € / u | |
|---------|----------------|-------|---|
| P904146 | 52 x 31,5 x 20 | 49,60 | 1 |

P904500 Cooling plate
Placa enfriadora
Plaque réfrigérante



- 12 °C



Adjustable to 1/1 GN pan.
Adaptable a cubeta GN 1/1.
Adaptable à bac GN 1/1.

| REF | W x D x H cm | € / u | |
|---------|-----------------|-------|---|
| P904500 | 47,5 x 27,7 x 3 | 68,45 | 5 |

P904145 Bread buffet display
Buffet pan
Buffet pain



Includes:
Wooden frame bread cutting board 1/1 GN container 20 mm

Incluye:
Marco madera cortador pan madera cubeta GN 1/1 20 mm

Inclus:
Cadre en bois plaque à découper pain en bois bac GN 1/1 20 mm

| REF | W x D x H cm | € / u | |
|---------|----------------|--------|---|
| P904145 | 57 x 37 x 14,5 | 191,85 | 1 |

P904142 Wooden bread cutting board
Cortador pan madera
Plaque à découper pain en bois



GN 1/1

| REF | W x D x H cm | € / u | |
|---------|---------------|-------|---|
| P904142 | 53 x 32,5 x 2 | 85,05 | 1 |

EXCLUSIVE



BUFFET TROLLEY WITH POSSIBLE TRANSFORMATION FROM AN EXPOSITOR TROLLEY TO A PRESENTATION TABLE
CARRO BUFFET CON POSIBILIDAD DE CONVERTIR EL CARRO EXPOSITOR EN MESA DE PRESENTACIÓN
CHARIOT BUFFET AVEC POSSIBILITÉ DE CONVERTIR LE CHARIOT D'EXPOSITION EN UNE TABLE DE PRÉSENTATION



***Two cover are included on the price**
**Dos tapas incluidas en precio*
**Deux tablettes comprises dans le prix*
P90492

Cover for 1/1 GN insert not included on the price
Tapa individual encaje GN 1/1 no incluida en precio
Tablette de bac GN 1/1 non comprise dans le prix
P90493

P90490 Black buffet trolley for 4 1/1 GN inserts
Carro buffet negro 4 GN 1/1
Chariot buffet noir pour 4 bacs GN 1/1



| REF | Type / Tipo | €/u | |
|----------------|-----------------------------|----------|---|
| P90490* | 4 X GN 1/1 | 1.490,30 | 1 |
| P90492 | Tapa / Cover / Tablette | 146,00 | 1 |
| P90493 | Tapa / Cover / Tablette 1/1 | 52,30 | 1 |

Outstanding combination of wood and aluminium

Elegante combinación de madera y aluminio
Combinaison élégante en bois et en aluminium



Wood with special waterproof treatment, easy to clean
Madera con tratamiento hidrófugo especial, de fácil limpieza
Bois avec un traitement hydrofuge spécial, facile à nettoyer

Reinforcement bar
Barra refuerzo nivel inferior
Barre de renforcement



Soundproof and revolving castors
Ø 125 mm, with brakes

Ruedas giratorias e insonoras de Ø 125 mm, con freno

Roulettes insonores et pivotantes de Ø 125 mm, avec freins

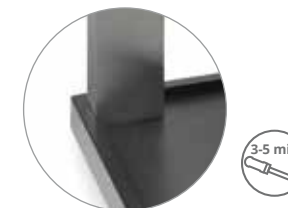

Delivered flatpacked between 3 to 5 minutes assembly

Se suministran desmontados entre 3 a 5 minutos de montaje

Livrés démontés entre 3 et 5 minutes de montage



Suitable for gastrorm sizes
Adaptado a medidas gastronorm
Adapté aux mesures gastronorme

TREND **Wooden-aluminium trolley 2 shelves**
Carro madera-aluminio 2 estanterías
Chariot en bois-aluminium 2 plateaux



| REF | Colour | €/u | |
|--------|----------------------|--------|---|
| P80220 | Negro / Black / Noir | 656,00 | 1 |

P80219 **Wooden gueridon trolley**
Gueridón o carro auxiliar madera
Chariot guéridon en bois



| REF | Colour | €/u | |
|--------|----------------------|--------|---|
| P80219 | Negro / Black / Noir | 534,25 | 1 |

P80216 **Oak melamine gueridon trolley**
Carro guerdón melamina roble
Chariot guéridon mélamine roure



| REF | €/u | |
|--------|--------|---|
| P80216 | 721,05 | 1 |

P90813 **Cutlery dispenser trolley**
Carro porta-cubiertos
Chariot porte couverts



Trays, dishes, GN containers and cutlery dispenser not included
No incluye porta-cubiertos, cubetas GN, platos ni bandejas
Ramasse-couverts, bacs GN, assiettes, et plateaux pas compris

| REF | €/u | |
|---------|----------|---|
| P908132 | 1.110,45 | 1 |
| P90813 | 1.026,60 | 1 |

P90814 **Cutlery bin**
Porta-cubiertos
Ramasse-couverts

EXCLUSIVE

4 x 1/3 GN
H max. 6,5 cm



GN containers not included
No incluye cubetas GN
Bacs GN non inclus

| REF | W x D x H mm | €/u | |
|---------|-----------------|--------|---|
| P908142 | 710 x 335 x 155 | 192,85 | 1 |
| P90814 | 710 x 335 x 155 | 140,65 | 1 |

14.8 Chafers & dispensers

Chafings y dispensadores
Chafers et distributeurs



An elegant yet versatile chafers with a low profile design for the best food presentation.

Glass top version allows viewing of food without opening chafers - maintaining food quality.

Removable cover with baffle, "stay put" hinge design holds cover in closed, 45° or 90° position.

Reinforced bracket with rubber table feet for longer life and to keep chafers in place.

Dripless cover and pans keep condensation off of food and tabletop.

Available with mirror-finished stainless steel or porcelain food pans.

Un elegante y versátil chafers con un diseño de perfil bajo para una mejor presentación.

Modelo con parte superior de vidrio que permite ver la comida sin abrir el chafers - manteniendo la calidad del alimento.

Tapa removible con bisagra de cierre lento. Tres ángulos de apertura, cerrada, 45° ó 90°.

Soporte reforzado con piés antideslizantes que permite una mayor estabilidad.

La tapa y cubeta con sistema anti-goteo mantienen la condensación fuera del alimento.

Se presenta con cubetas de acero inoxidable brillante o de porcelana.

Un chafers élégant à la fois polyvalent et discret pour la meilleure présentation des plats.

Le modèle muni d'un couvercle en verre permet de voir le contenu sans ouvrir le chafers - tout en préservant la qualité des aliments.

Couvercle amovible équipé d'un déflecteur et d'une charnière bloquante qui permet de maintenir le couvercle fermé, à 45° ou à 90°.

Support renforcé avec des pieds de table en caoutchouc afin d'offrir une durée de vie plus longue et un meilleur maintien des chafers.

Le couvercle antigouttes et les bacs empêchent la condensation des aliments et de la table.

Disponibles avec bac à aliments en inox ultra-brillant ou en porcelaine.

4644010 Rectangular chafing dish with crystal lid
Chafing dish rectangular con tapa de cristal
Chauffe-plat rectangulaire avec couvercle en verre

SS Stainless steel
Cr Crystal
induction

NEW!



| REF | W x D x H cm | €/u | |
|---------|--------------------|----------|---|
| 4644010 | 58,4 x 46,5 x 19,8 | 1.582,00 | 1 |

4644020 Square chafing dish with crystal lid
Chafing dish cuadrado con tapa de cristal
Chauffe-plat carré avec couvercle en verre

SS Stainless steel
Cr Crystal
induction

NEW!



| REF | W x D x H cm | €/u | |
|---------|------------------|----------|---|
| 4644020 | 46,4 x 46,4 x 17 | 1.381,00 | 1 |

Chafers & dispensers 14.8

Chafings y dispensadores
Chafers et distributeurs

46132 Square chafing dish
Chafing dish cuadrado
Chauffe-plat carré

SS Stainless steel
induction

NEW!



| REF | W x D x H cm | €/u | |
|-------|--------------------|----------|---|
| 46132 | 39,2 x 41,3 x 20,3 | 1.195,00 | 1 |

46134 Glass top S/S chafers with S/S trim
Chafing dish cuadrado con tapa cristal
Chauffe-inox à couvercle en verre

SS Stainless steel
Cr Crystal
induction



| REF | W x D x H cm | L | €/u | |
|-------|-----------------|-----|----------|---|
| 46134 | 392 x 176 x 412 | 5,8 | 1.298,40 | 1 |

46124 Glass top S/S chafers with S/S trim
Chafing dish redondo con tapa cristal
Chauffe-inox à couvercle en verre

SS Stainless steel
Cr Crystal
induction

NEW!



Details in Golden colour.
Detalles en color dorado.
Détails en couleur dorée.

| REF | Ø cm | H cm | L | €/u | |
|-------|------|------|-----|--------|---|
| 46124 | 39,4 | 8 | 5,8 | 987,00 | 1 |

46125 Glass top S/S chafers with S/S trim
Chafing dish redondo con tapa cristal
Chauffe-inox à couvercle en verre

SS Stainless steel
Cr Crystal
induction



| REF | Ø cm | H cm | L | €/u | |
|-------|------|------|-----|--------|---|
| 46125 | 39,4 | 8 | 5,8 | 987,00 | 1 |

46131 Food pan
Fuente interior redonda
Bac à aliments

SS Stainless steel



| REF | cm | L | €/u | |
|-------|----------|-----|--------|-------|
| 46131 | 39,4 x 7 | 5,6 | 176,00 | 1 |
| 46861 | 39,4 x 7 | 3,8 | 98,50 | 1 NEW |

46137 Food pan
Fuente interior cuadrada
Bac à aliments

SS Stainless steel



| REF | W x D x H cm | L | €/u | |
|-------|-------------------|-----|--------|---|
| 46137 | 39,2 x 7,1 x 39,2 | 6,3 | 218,85 | 1 |

14.8 Chafers & dispensers

Chafings y dispensadores
Chafers et distributeurs



P3875 Rectangular chafing dish roll top lid
Chafing dish rectangular con tapa roll top
Chafing dish rectangulaire avec couvercle roll top



Stand, water pan, insert, lid and St/Steel handles.
With 2 burners.

Soporte, recipiente, cubeta, tapa y asas de chapa en acero inox.
Con 2 quemadores.

Support, récipient, bac, couvercle et poignées en acier inox.
Avec 2 brûleurs.

| REF | W x D x H cm | L | € / u | |
|---------|--------------|-----|--------|---|
| P387500 | 74 x 45 x 41 | 9,0 | 412,80 | 1 |

P8975 Round chafing dish roll top lid
Chafing dish redondo tapa roll top
Chafing dish rond avec couvercle roll top

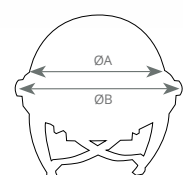

Max. opening: 180°.
Apertura máxima: 180°.
Ouverture maximale: 180°.

| REF | ØA cm | ØB cm | H cm | € / u | |
|---------|-------|-------|------|--------|---|
| P897500 | 35 | 51,5 | 48,5 | 368,65 | 1 |

Chafers & dispensers 14.8

Chafings y dispensadores
Chafers et distributeurs



46080 Oblong roll top chafer
Chafer apaisado con tapa roll top
Couvercle roll top rectangulaire chauffe-plat



NEW!

Stand, water pan, insert, lid and St/Steel handles.
With 2 burners.

Soporte, recipiente, cubeta, tapa y asas de chapa en acero inox.
Con 2 quemadores.

Support, récipient, bac, couvercle et poignées en acier inox.
Avec 2 brûleurs.

| REF | W x D x H cm | € / u | |
|-------|--------------------|----------|---|
| 46080 | 65,6 x 44,5 x 46,7 | 1.586,00 | 1 |

P387 Chafing dish with roll top lid
Chafing dish con tapa roll top
Chafing dish avec couvercle "roll top"



Stand, water pan, insert, lid and St/Steel handles.
With 2 burners.

Soporte, recipiente, cubeta, tapa y asas de chapa en acero inox.
Con 2 quemadores.

Support, récipient, bac, couvercle et poignées en acier inox.
Avec 2 brûleurs.

| REF | W x D x H cm | L | € / u | |
|---------|--------------|-----|--------|---|
| P387065 | 65 x 38 x 39 | 9,5 | 309,95 | 1 |

P379 Chafing dish with lid
Chafing dish con tapa
Chafing dish avec couvercle



Stand, water pan, insert, lid and St/Steel handles.
With 2 burners.

Soporte, recipiente, cubeta, tapa y asas de chapa en acero inox.
Con 2 quemadores.

Support, récipient, bac, couvercle et poignées en acier inox.
Avec 2 brûleurs.

| REF | W x D x H cm | L | € / u | |
|---------|--------------|-----|--------|---|
| P379065 | 65 x 35 x 34 | 9,5 | 244,80 | 1 |

46095 Gravy/sauce chafer
Chafer de salsas
Réchauffeur de sauce



NEW!

| REF | W x D x H cm | € / u | |
|-------|--------------------|--------|---|
| 46095 | 31,8 x 29,2 x 37,8 | 947,25 | 1 |

46070 Round roll top chafer
Chafer redondo con tapa roll top
Couvercle roll top chauffe-plat



NEW!

| REF | W x D x H cm | € / u | |
|-------|------------------|----------|---|
| 46070 | 49,2 x 48 x 46,5 | 1.111,00 | 1 |

P3795 Economical chafing dish with lid
Chafing dish económico con tapa
Chafing dish économique avec couvercle



Stand, water pan, insert, lid and St/Steel handles.
With 2 burners.

Soporte, recipiente, cubeta, tapa y asas de chapa en acero inox.
Con 2 quemadores.

Support, récipient, bac, couvercle et poignées en acier inox.
Avec 2 brûleurs.

| REF | W x D x H cm | L | € / u | |
|---------|--------------|---|--------|---|
| P379500 | 65 x 35 x 32 | 9 | 125,80 | 1 |

14.8 Chafers & dispensers

Chafings y dispensadores
Chafers et distributeurs

P950000 Electric heating unit for chafing dish
Elemento eléctrico para chafing dish
Corps de chauffe pour chafing dish



For / Para / Pour:
P387500, P897500, P387065, P379065, P379500

| REF | W | € / u | |
|---------|-----|--------|---|
| P950000 | 240 | 214,60 | 1 |

P962 Hot tray warmer
Calentador de platos o bandejas
Réchaud



P3722 Burner holder for chafing dish
Contenedor para combustible de chafing dish
Porte-brûleur pour chafing dish



Adaptable. REF:
P379, P387, P898, P8991

| REF | € / u | |
|---------|-------|----|
| P372200 | 10,00 | 24 |

P3871 Chafing dish fuel
P3872 Fuel para chafing dish
Fuel pour chafing dish



| REF | cm | Lenght / Duración / Durée | € / u | |
|---------|---------|---------------------------|-------|----|
| P387100 | 65 x 55 | 3 h | 2,45 | 75 |
| P387200 | 83 x 60 | 6 h | 4,60 | 60 |

46110 Universal electric chafer heater
Elemento eléctrico universal para chafing dish
Résistance électrique pour chafers

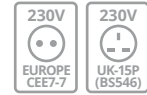

Sized to fit standard fuel opening.
Dimensiones compatibles con el orificio para combustible estándar.
Dimensions compatibles avec l'orifice pour combustible standard.

| REF | For / Para | V | W | A | Ench. Plug | € / u | |
|-------|------------|-----|---------|-----|------------|--------|---|
| 46110 | EU | 230 | 120/230 | 1.0 | EU | 378,20 | 1 |
| 46115 | UK | 230 | 120/230 | 1.0 | UK | 378,20 | 1 |

| REF | Burners / Quemadores / Brûleurs | W x D x H cm | € / u | |
|---------|---------------------------------|----------------|-------|----|
| P962002 | 2 | 370 x 175 x 70 | 57,80 | 10 |
| P962003 | 3 | 430 x 175 x 70 | 90,20 | 10 |

St/Steel with aluminium cover plate.
Inox con placa base de aluminio.
Inox avec plaque couvercle en aluminium.

2 or 3 burners.
2 ó 3 quemadores.
2 ou 3 brûleurs.

P685 Chafing dish fuel barrel
Fuel para chafing dish
Bidón fuel chafing dish



No soot. No smell
Sin hollín. Sin olor
Pas de suie. Inodore

| REF | L | KG | € / u | |
|---------|---|----|-------|---|
| P685004 | 5 | 5 | 37,75 | 3 |

Thanks to its special formula no storage or transport restriction are involved. Resealable. Non spill - Non drip. Non flammable. Non combustible. Non toxic fuel. Easy open & close. Container does not become hot to touch. Does not evaporate if left uncapped.

Gracias a su fórmula especial no hay ninguna restricción especial por almacenaje o transporte. No gotea ni se derrama. No se evapora si se deja abierto. Puede guardarse si no se consume todo. No inflamable. No tóxico. Fácil de abrir y cerrar. La lata no se calienta. Fácil de encender una vez apagada.

Grâce à sa formule spéciale il n'y pas de restriction pour le stockage et le transport. Hermétique. Non inflammable. Non combustible. Non toxique. Facile à ouvrir et fermer. On peut le garder si on ne le consomme pas tout. Facile à allumer une fois éteint.

Chafers & dispensers 14.8

Chafings y dispensadores
Chafers et distributeurs



P903 Cooling plate
Placa enfriadora
Plaque réfrigérante



| REF | Type / Tipo | cm | € / u | |
|---------|-------------|-------------|--------|---|
| P903001 | 1/1 | 53 x 32,5 | 204,35 | 4 |
| P903002 | 1/2 | 32,5 x 26,5 | 140,45 | 6 |

For an easy and hygienic presentation of cold food. Simple place in the freezer. Minimum 4 hour under -4°C. Tolerance under 23°C: 5-6h.

Para una presentación fácil e higiénica de alimentos fríos en los buffets. En el congelador: Mínimo 4h por debajo de los -4 °C. Aguanta 5-6h con temperaturas por debajo de los 23 °C.

Pour une présentation hygienique et facile des aliments froids sur les buffets. Au congélateur. Minimum 4h à des températures inférieures à -4 °C. Résistance à des températures inférieures à 23 °C: 5-6h.

78710 Bain maries
Baño maría
Bain-marie



| REF | Ø cm | H cm | L | € / u | |
|-------|------|------|------|-------|---|
| 78710 | 10,5 | 14,5 | 1,20 | 31,15 | 6 |
| 78720 | 12,5 | 17,0 | 1,90 | 39,70 | 6 |
| 78725 | 15,5 | 10,0 | 1,90 | 39,70 | 6 |
| 78730 | 15,5 | 18,5 | 3,30 | 42,65 | 6 |
| 78740 | 16,5 | 19,5 | 4,00 | 46,75 | 6 |
| 78760 | 18,5 | 22,0 | 5,70 | 58,95 | 6 |

14.8 Chafers & dispensers

Chafings y dispensadores
Chafers et distributeurs



4609 Coffee urn
Urna de café
Boîte à café

NEW!

SS
Stainless steel



46093 46094

| REF | W x D x H cm | € / u | |
|-------|--------------------|----------|---|
| 46093 | 31,6 x 34,3 x 50,3 | 1.145,00 | 1 |
| 46094 | 39,4 x 41,8 x 54,5 | 1.480,00 | 1 |

46285 Cold beverage server
Dispensador de bebidas frías
Distributeur boisson froide

NEW!

SS
Stainless steel

PC
Polycarbonate



| REF | W x D x H cm | € / u | |
|-------|------------------|--------|---|
| 46285 | 20,3 x 28 x 53,3 | 788,50 | 1 |

4635810 Somerville cold beverage server
Dispensador de bebidas frías-Somerville
Distributeur de boisson froide Somerville

NEW!

SS
Stainless steel

PC
Polycarbonate



| REF | W x D x H cm | € / u | |
|---------|----------------|----------|---|
| 4635810 | 24,6 x 29 x 64 | 1.147,00 | 1 |

4635110 Somerville milk dispenser
Dispensador de leche-Somerville
Distributeur de lait Somerville

NEW!

SS
Stainless steel



| REF | W x D x H cm | € / u | |
|---------|--------------------|----------|---|
| 4635110 | 20,3 x 32,7 x 41,4 | 1.342,10 | 1 |

Chafers & dispensers 14.8

Chafings y dispensadores
Chafers et distributeurs

P8992 Juice dispenser St/Steel
Dispensador de zumos - acero inox
Distributeur à jus - acier inox

SS
Stainless steel

PC
Polycarbonate



| REF | L | € / u | |
|---------|---|--------|---|
| P899200 | 8 | 276,70 | 1 |

P8993 St/Steel milk dispenser
Dispensador de leche - acero inox
Distributeur à lait - acier inox

SS
Stainless steel



| REF | L | € / u | |
|---------|---|--------|---|
| P899300 | 8 | 301,85 | 1 |

4635210 Double Cereal Dispenser
Dispensador de cereales doble
Distributeur à céréales double

SS
Stainless steel

PC
Polycarbonate



| REF | W x D x H cm | L (x2) | € / u | |
|---------|--------------|--------|--------|---|
| 4635210 | 31 x 22 x 60 | 3,8 | 879,10 | 1 |

T3660 D-Lux cereal dispenser
Dispensador de cereales D-Lux
Distributeur à céréales D-Lux

SS
Stainless steel

Ac
Acrylic



| REF | W x D x H cm | L | € / u | |
|-------|--------------------|---|--------|---|
| T3660 | 25,4 x 35,6 x 68,6 | 8 | 471,15 | 1 |

14.9 Bowls & serving trays

Bols & bandejas de servicio
Bols & plateaux

18/10
Stainless steel

Double wall insulated serving bowls that allows keeping the food temperature, whether cold or hot.

Construcción aislante de pared doble que permite conservar la temperatura de los alimentos, ya sean fríos o calientes.

Construction d'isolation à double paroi qui permet de maintenir la température de la nourriture, froide ou chaude.



Will not TRANSPIRE. Requires no preheating or chilling
No transpiran. No es necesario precalentar o enfriar
Pas de condensation sur les parois. N'exige aucun préchauffage ou refroidissement

Insulating walls that keep food at service temperature
Paredes aislantes que mantienen los alimentos a la temperatura de servicio
Construction isolant qui garde les aliments à la température de service

HAND WASHING
LAVAR A MANO
HAND WASHING

COLD RETENTION: Double wall insulated bowls TEST PROTOCOL, 2004
RETENCIÓN DEL FRÍO: Bols aislantes de doble pared PROTOCOLO DE PRUEBA, 2004
RÉTENTION DU FROIDE: Construction d'isolation à double paroi PROTOCOLE D'ESSAI, 2004

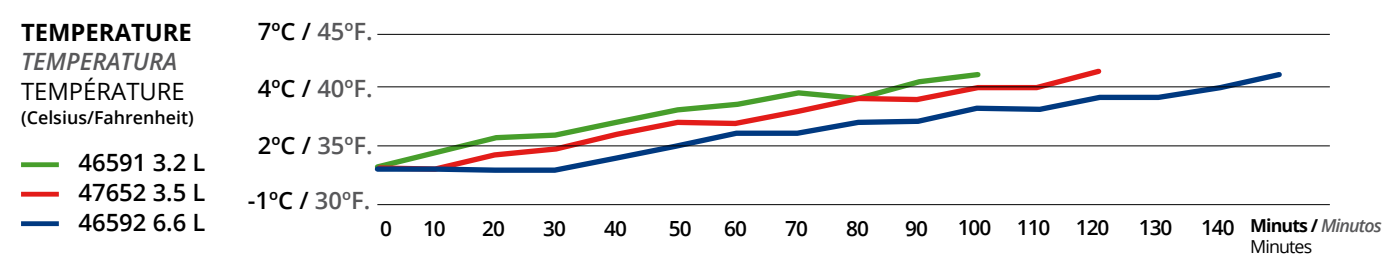

- Potato salad was placed in different bowls. Filling ¾ of the capacity of the bowl.
- Initial temperature of the food 0.6°C; ambient temperature 20.6°C.
- The temperature in the centre of the salad was recorded every 10 minutes.
- The test concluded when the food reached a temperature of 5°C.

Bowls & serving trays 14.9

Bols & bandejas de servicio
Bols & plateaux

18/10
Stainless steel

46590 Round colored double wall bowls
Bol colores redondo doble pared
Bols ronds de service à double paroi isothermes en couleurs



| REF | Ø cm | H cm | L | €/u | ☐ |
|---------------|------|------|-----|--------|---|
| 46590 + COLOR | 18,4 | 10,3 | 1,6 | 69,85 | 6 |
| 46591 + COLOR | 24,1 | 12,9 | 3,2 | 104,95 | 6 |
| 46592 + COLOR | 30,0 | 16,5 | 6,6 | 148,00 | 3 |

47632 Square colored double wall bowls
Bol colores cuadrado doble pared
Bols carrés de service à double paroi isothermes en couleurs



| REF | cm | H cm | L | €/u | ☐ |
|---------------|-------------|------|-----|--------|----|
| 47632 + COLOR | 18,4 x 18,4 | 8,7 | 1,7 | 71,65 | 12 |
| 47634 + COLOR | 21,6 x 21,6 | 10,8 | 3,0 | 94,85 | 6 |
| 47635 + COLOR | 25,8 x 25,8 | 13,0 | 4,9 | 122,05 | 4 |

46584 Angled beehive bowls
Bol inclinado doble pared
Bols nid d'abeilles à paroi inclinée



| REF | Ø cm | H cm | L | €/u | ☐ |
|-------|------|------|------|--------|---|
| 46584 | 18,8 | 13,9 | 0,95 | 45,60 | 6 |
| 46585 | 24,0 | 17,3 | 1,7 | 71,85 | 6 |
| 46586 | 30,0 | 20,9 | 3,5 | 104,75 | 2 |
| 46582 | 35,0 | 23,9 | 4,7 | 160,85 | 2 |

47619 Double-wall square beehive serving bowls
Bol estriado cuadrado doble pared
Bol lis carré double paroi



| REF | W x D x H cm | L | €/u | ☐ |
|-------|--------------------|-----|--------|----|
| 47619 | 13,9 x 13,9 x 7 | 0,7 | 39,40 | 6 |
| 47632 | 18,5 x 18,5 x 8,9 | 1,7 | 49,55 | 12 |
| 47634 | 21,8 x 21,8 x 10,8 | 3,0 | 67,65 | 6 |
| 47635 | 24,4 x 24,4 x 13,1 | 4,9 | 91,15 | 4 |
| 47637 | 29,9 x 29,9 x 15 | 7,8 | 121,85 | 3 |

46587 Beehive style double-wall serving bowls
Bol estridado redondo doble pared
Bol à bande rond double paroi



| REF | Ø cm | H cm | L | €/u | ☐ |
|-------|------|------|-----|--------|---|
| 46587 | 14,4 | 7,6 | 0,7 | 32,25 | 6 |
| 46590 | 18,4 | 10,3 | 1,6 | 48,90 | 6 |
| 46591 | 24,1 | 12,9 | 3,2 | 77,45 | 6 |
| 46592 | 30,0 | 16,5 | 6,6 | 113,65 | 3 |
| 46569 | 35,0 | 17,5 | 9,6 | 161,75 | 2 |

46665 Beehive style double-wall serving bowls
Bol redondo doble pared con aro brillante
Bol bande brillant rond double paroi



| REF | Ø cm | H cm | L | €/u | ☐ |
|-------|------|------|-----|-------|---|
| 46665 | 14,4 | 7,6 | 0,7 | 32,25 | 6 |
| 46666 | 18,4 | 10,3 | 1,6 | 48,45 | 6 |
| 46667 | 24,1 | 12,9 | 3,2 | 76,55 | 6 |

14.9 Bowls & serving trays

Bols & bandejas de servicio
Bols & plateaux

18/10
Stainless
steel

Satin-finished rim and mirror-finished interior creates a visual contrast that accentuates the food product

Borde con acabado satinado e interior brillante, creando una elegante contraste visual

Le rebord satiné et l'intérieur ultra-brillant crée un contraste visuel qui met en valeur les plats

82093 Rectangular Stainless Steel serving trays
Bandeja servicio rectangular acero inoxidable
Plateau service rectangulaire



| REF | cm | €/u | |
|-------|-------------|-------|---|
| 82093 | 30,5 x 22,9 | 46,20 | 3 |
| 82094 | 45,7 x 25,4 | 67,80 | 3 |
| 82095 | 53,3 x 30,5 | 89,40 | 3 |

46221 Curved tray
Bandeja curva
Plateau incurvé



NEW!

| REF | cm | €/u | |
|-------|-------------|-------|---|
| 46221 | 19,1 x 19,1 | 40,90 | 1 |

P3174 Economical oval serving dish with rolled edge
Fuente oval borde vuelto económica
Plat ovale à bords ronds économique

Mirror finished
Pulido brillante
Polissage brillant



| REF | cm | €/u | |
|---------|-----------|-------|----|
| P317425 | 25 x 17,5 | 7,75 | 60 |
| P317430 | 30 x 21,0 | 8,70 | 60 |
| P317435 | 35 x 24,0 | 10,35 | 60 |
| P317440 | 40 x 26,5 | 11,40 | 40 |
| P317445 | 45 x 29,5 | 13,90 | 30 |
| P317450 | 50 x 34,0 | 17,75 | 24 |

P317 Oval serving dish with rolled edge
Fuente oval borde vuelto
Plat ovale à bords ronds

Satin finished
Pulido satinado
Polissage satiné



| REF | cm | €/u | |
|---------|-----------|-------|---|
| P317025 | 25 x 17,2 | 10,75 | 1 |
| P317030 | 30 x 20,2 | 13,10 | 1 |
| P317035 | 35 x 23,3 | 15,90 | 1 |
| P317040 | 40 x 26,7 | 19,75 | 1 |
| P317045 | 45 x 29,2 | 22,10 | 1 |
| P317050 | 50 x 31,2 | 28,70 | 1 |

Bowls & serving trays 14.9

Bols & bandejas de servicio
Bols & plateaux

P907 St/Steel soup tureen with stand
Sopera inox con base
Soupière inox avec pied

SS
Stainless
steel

Mirror finished
Pulido brillante
Polissage brillant



| REF | Ø cm | L | €/u | |
|---------|------|------|-------|---|
| P907024 | 24 | 2,50 | 18,40 | 6 |
| P907026 | 26 | 3,50 | 21,00 | 6 |

P927 Acrylic round salad bowl
Ensaladera acrílica redonda
Saladier rond acrylique

Ac
Acrylic



| REF | Ø cm | H cm | €/u | |
|---------|-------------|------|-------|---|
| P927000 | 25,8 x 15,8 | 15,8 | 33,00 | 6 |

P928 Acrylic Squared salad bowl
Ensaladera acrílica cuadrada
Saladier carré acrylique

Ac
Acrylic



P928000



P928001

| REF | W x D x H cm | €/u | |
|---------|--------------------|-------|----|
| P928000 | 28,5 x 28,5 x 12,4 | 17,00 | 12 |
| P928001 | 14,7 x 14,7 x 7 | 3,65 | 48 |

See products on / Ver productos en / Voir produits en page

P. 388

Bandejas de servicio y buffet
Bandejas de servicio y buffet
Plateaux de service et de buffet





SS
Stainless
steel

Serving tools 14.10

Utensilios de servicio
Ustensiles de service buffet

CLASSIC LINE

**BEST
SELLER**



P361 One piece ladle
Cacillo monobloc
Louche monobloc



| REF | Ø cm | L cm | L | €/u | 📦 |
|---------|------|------|------|-------|-----|
| P361000 | 9 | 30 | 0,10 | 14,75 | 120 |

P362 One piece skimmer
Espumadera monobloc
Écumoire monobloc



| REF | Ø cm | L cm | L | €/u | 📦 |
|---------|------|------|-------|-------|-----|
| P362000 | 11 | 33,5 | 10,40 | 13,90 | 120 |

P363 One piece turner
Espátula monobloc
Spatule monobloc



| REF | L cm | €/u | 📦 |
|---------|------|-------|-----|
| P363000 | 32 | 12,35 | 120 |

P364 One piece serving spoon
Cuchara de servicio monobloc
Cuillère de service monobloc



| REF | L cm | €/u | 📦 |
|---------|------|-------|-----|
| P364000 | 31 | 11,10 | 120 |

P365 One piece fork
Tenedor monobloc
Fourchette monobloc



| REF | L cm | €/u | 📦 |
|---------|------|-------|-----|
| P365000 | 32 | 10,00 | 120 |

P366 One piece sauce ladle
Cacillo salsas monobloc
Cuillère à sauces monobloc



| REF | Ø cm | L cm | L | €/u | 📦 |
|---------|------|------|------|-------|-----|
| P366000 | 7 | 28 | 0,10 | 13,25 | 120 |

P367 One piece salad spoon
Cuchara ensalada monobloc
Cuillère à salade monobloc



| REF | L cm | €/u | 📦 |
|---------|------|-------|----|
| P367000 | 30 | 11,15 | 72 |

P368 Carving knife
Cuchillo cocina
Couteau à pâtisserie



| REF | L cm | €/u | 📦 |
|---------|------|------|-----|
| P368000 | 28,5 | 8,45 | 240 |

P369 Cake server
Pala pasteles
Pelle à gâteau



| REF | L cm | €/u | 📦 |
|---------|------|------|-----|
| P369000 | 22 | 9,05 | 120 |

14.10 Serving tools

Utensilios de servicio
Ustensiles de service buffet



ERGO LINE



Mirror polishing.
Pulido brillante.
Polissage brillant.

P3611 One piece ladle
Cacillo monobloc
Louche monobloc

| REF | Ø cm | L cm | L | €/u | |
|---------|------|------|------|-------|----|
| P361100 | 9,5 | 32 | 0,15 | 10,60 | 48 |

P3621 One piece skimmer
Espumadera monobloc
Écumoire monobloc

| REF | Ø cm | L cm | L | €/u | |
|---------|------|------|------|------|----|
| P362100 | 11 | 35 | 7,15 | 9,60 | 48 |

P3631 One piece turner
Espátula monobloc
Spatule monobloc

| REF | L cm | €/u | |
|---------|------|------|----|
| P363100 | 37 | 9,05 | 48 |

P3641 One piece serving spoon
Cuchara de servicio monobloc
Cuillère de service monobloc

| REF | L cm | €/u | |
|---------|------|------|----|
| P364100 | 34,5 | 8,10 | 48 |

P3651 One piece fork
Tenedor monobloc
Fourchette monobloc

| REF | L cm | €/u | |
|---------|------|------|----|
| P365100 | 37 | 7,10 | 48 |

P3671 Spaghetti server
Cuchara para spaghetti
Cuillère à spaghetti

| REF | L cm | €/u | |
|---------|------|------|----|
| P367100 | 35 | 8,10 | 48 |

P3691 Cake server
Pala pasteles
Pelle à gâteau

| REF | L cm | €/u | |
|---------|------|------|----|
| P369100 | 31 | 7,25 | 48 |

Serving tools 14.10

Utensilios de servicio
Ustensiles de service buffet



COMET LINE



Mat satiny finished.
Pulido satinado mate.
Poli satiné mat.

P341 One piece ladle. 18% cr. St/Steel
Cacillo monobloc. Acero inox 18% cr.
Louche monobloc. inox 18% cr.

| REF | Ø cm | L cm | L | €/u | |
|---------|------|------|------|------|-----|
| P341000 | 8,5 | 28 | 0,10 | 8,45 | 120 |

P342 One piece skimmer. 18% cr. St/Steel
Espumadera monobloc. inox 18% cr.
Écumoire monobloc. inox 18% cr.

| REF | Ø cm | L cm | €/u | |
|---------|------|------|------|-----|
| P342000 | 11 | 33 | 8,35 | 120 |

P343 One piece turner. 18% cr. St/Steel
Espátula monobloc. inox 18% cr.
Spatule monobloc. inox 18% cr.

| REF | L cm | €/u | |
|---------|------|------|-----|
| P343000 | 33 | 6,50 | 120 |

P344 One piece fork. 18% cr. St/Steel
Tenedor monobloc. inox 18% cr.
Fourchette monobloc. inox 18% cr.

| REF | L cm | €/u | |
|---------|------|------|-----|
| P344000 | 30 | 6,25 | 120 |

P345 One piece spoon. 18% cr. St/Steel
Cuchara monobloc. inox 18% cr.
Cuillère monobloc. inox 18% cr.

| REF | L cm | €/u | |
|---------|------|------|-----|
| P345000 | 34 | 6,60 | 120 |

48144 Steak knife black plastic handle
Cuchillo chuletero, mango plástico negro
Couteau Steak manche noir plastique

| REF | Blade / Hoja / Lame L cm | Total L cm | €/u | |
|-------|--------------------------|------------|-------|----|
| 48144 | 12,4 | 25,1 | 51,55 | 12 |

48148 Steak knife riveted wooden handle
Cuchillo chuletero, mango plástico madera
Couteau Steak manche bois plastique

| REF | Blade / Hoja / Lame L cm | Total L cm | €/u | |
|-------|--------------------------|------------|-------|----|
| 48148 | 12,7 | 25,1 | 39,00 | 12 |

14.10 Serving tools

Utensilios de servicio
Ustensiles de service buffet

SS
Stainless
steel

NEW!

46905 Ladle with one spout
Cacillo con un pico lateral
Louche avec bec latéral



| REF | L cm | € / u | |
|-------|-------|-------|----|
| 46905 | 28,71 | 13,75 | 12 |

46907 Ladle with one spout
Cacillo con un pico lateral
Louche avec bec latéral



| REF | L cm | ml | € / u | |
|-------|------|-------|-------|----|
| 46907 | 32 | 59,15 | 17,00 | 12 |

46909 Ladle
Cacillo
Louche



| REF | L cm | € / u | |
|-------|------|-------|----|
| 46909 | 32 | 18,45 | 12 |

46936 Pastry server
Servidor de pasteles
Pelle de service



| REF | L cm | € / u | |
|-------|------|-------|----|
| 46936 | 28 | 9,95 | 12 |

46952 Serving spoon
Cuchara de servicio
Cuillère de service



| REF | L cm | € / u | |
|-------|------|-------|----|
| 46952 | 29,5 | 12,00 | 12 |

46960 Slotted serving spoon
Cuchara perforada para servir
Cuillère à fente de service



| REF | L cm | € / u | |
|-------|------|-------|----|
| 46960 | 30,5 | 13,00 | 12 |

6440 Spoon
Cuchara
Cullière



| REF | L cm | € / u | |
|-------|-------|-------|----|
| 64403 | 33,60 | 15,20 | 12 |
| 64404 | 33,60 | 15,20 | 12 |
| 64406 | 39,37 | 18,55 | 12 |
| 64407 | 39,37 | 18,55 | 12 |

Serving tools 14.10

Utensilios de servicio
Ustensiles de service buffet

SS
Stainless
steel

Ny
Nylon



dishwasher
-40°C +210°C

P33621 Ladle
Cacillo
Louche



| REF | L cm | Lts | € / u | |
|--------|------|------|-------|---|
| P33621 | 35 | 0,08 | 7,80 | 1 |

P33622 Serving spoon
Cuchara de servicio
Cuillère de service



| REF | L cm | € / u | |
|--------|------|-------|---|
| P33622 | 35 | 7,80 | 1 |

P33623 Slotted spoon
Cuchara perforada
Cuillère à fente



| REF | L cm | € / u | |
|--------|------|-------|---|
| P33623 | 35 | 7,80 | 1 |

P33624 Turner
Espátula
Patule



| REF | L cm | € / u | |
|--------|------|-------|---|
| P33624 | 35 | 7,80 | 1 |

P33625 Spaghetti server
Cuchara para spaghetti
Cuillère à spaghetti



| REF | L cm | € / u | |
|--------|------|-------|---|
| P33625 | 35 | 7,80 | 1 |

14.10 Serving tools

Utensilios de servicio
Ustensiles de service buffet



dishwasher

P33801 Serving spoon
Cuchara de servicio
Cuillère de service



| REF | L cm | € / u | Icon |
|--------|------|-------|------|
| P33801 | 30,5 | 5,15 | 1 |

P33802 Slotted spoon
Cuchara perforada
Cuillère à fente



| REF | L cm | € / u | Icon |
|--------|------|-------|------|
| P33802 | 30,5 | 5,80 | 1 |

P33803 Turner
Espátula
Spatule



| REF | L cm | € / u | Icon |
|--------|------|-------|------|
| P33803 | 30,5 | 5,15 | 1 |

P33804 Spaghetti server
Cuchara para spaghetti
Cuillère à spaghetti



| REF | L cm | € / u | Icon |
|--------|------|-------|------|
| P33804 | 30,5 | 5,80 | 1 |

P33805 One piece fork
Tenedor de mesa
Fourchette



| REF | L cm | € / u | Icon |
|--------|------|-------|------|
| P33805 | 30,5 | 5,15 | 1 |

P33806 Serving tong
Pinza de servicio
Pince de service



| REF | L cm | € / u | Icon |
|--------|------|-------|------|
| P33806 | 28 | 7,15 | 1 |

P33807 Bread spoon
Pinza de pan
Pince à pain



| REF | L cm | € / u | Icon |
|--------|------|-------|------|
| P33807 | 25,5 | 7,15 | 1 |

P33808 Salad hands
Servidor de ensalada
Serveur salade



Pack: 2 u.

| REF | L cm | € / u | Icon |
|--------|------|-------|------|
| P33808 | 17,5 | 7,75 | 1 |

P33809 Knife
Cuchillo
Couteau



| REF | L cm | € / u | Icon |
|--------|------|-------|------|
| P33809 | 17,5 | 1,90 | 1 |

Serving tools 14.10

Utensilios de servicio
Ustensiles de service buffet



P358 Coloured BPA Free utility tong
Pinza buffet BPA Free color
Pince buffet SANS BPA en couleurs



REF 358 + L + COLOR



| REF | L cm | Clear Transp. | White Blanco Blanc | Red Rojo Rouge | Black Negro Noir | € / u | Icon |
|------|------|---------------|--------------------|----------------|------------------|-------|------|
| P358 | 23 | 0 | 1 | 2 | 7 | 4,10 | 1 |

46938 Buffet tong
Pinza buffet
Pince à buffet



| REF | L cm | € / u | Icon |
|-------|------|-------|------|
| 46938 | 30,5 | 15,05 | 6 |

46926 Serving tong
Pinza servicio
Pince de service

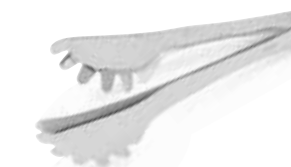

| REF | L cm | € / u | Icon |
|-------|------|-------|------|
| 46926 | 21 | 13,20 | 12 |

4698 Spaghetti tong
Pinza espagueti
Pince à spaghettis



NEW!

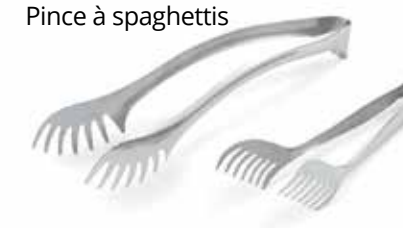

| REF | L cm | € / u | Icon |
|-------|------|-------|------|
| 46988 | 23,0 | 19,95 | 12 |
| 46989 | 29,2 | 29,00 | 12 |

14.10 Serving tools

Utensilios de servicio
Ustensiles de service buffet



P359 Serving tong
Pinza de servicio
Pince de service



| REF | L cm | €/ u | |
|---------|------|------|---|
| P359000 | 24 | 9,60 | 1 |

P353 Salad tong
Pinza ensalada
Pince à salade



| REF | L cm | €/ u | |
|---------|------|-------|-----|
| P353000 | 26,5 | 20,60 | 120 |

46928 Bread tong
Pinza pan
Pince à pain



| REF | L cm | €/ u | |
|-------|------|-------|----|
| 46928 | 23,5 | 15,60 | 12 |

P606 Bread tong
Pinza pan
Pince à pain



| REF | L cm | €/ u | |
|---------|------|-------|----|
| P606000 | 25 | 22,10 | 72 |

P605 Pasta tong
Pinza pasta
Pince à pâtes



| REF | L cm | €/ u | |
|---------|------|------|-----|
| P605000 | 24 | 6,00 | 120 |

P351 Spaghetti tong
Pinza spaghetti
Pince à spaghetti



| REF | L cm | €/ u | |
|---------|------|------|-----|
| P351000 | 19 | 4,25 | 120 |

P352 Cake tong
Pinza repostería
Pince à gâteau



| REF | L cm | €/ u | |
|---------|------|-------|-----|
| P352000 | 18 | 11,15 | 120 |

P617 Tong with ring
Pinza anillas
Tong with ring



| REF | L cm | €/ u | |
|---------|------|------|-----|
| P617017 | 17 | 6,90 | 100 |

Serving tools 14.10

Utensilios de servicio
Ustensiles de service buffet



P618 Burger tong
Pinza hamburguesa
Pince à "burger"



| REF | L cm | €/ u | |
|---------|------|-------|---|
| P618000 | 24 | 13,25 | 1 |

46929 Pastry tong
Pinza pastelería
Pince à pâtisserie



| REF | L cm | €/ u | |
|-------|------|------|----|
| 46929 | 20 | 9,20 | 24 |

P615 Nut cracker
Cascanueces
Casse-noix



| REF | L cm | €/ u | |
|---------|------|------|-----|
| P615000 | 16,5 | 8,50 | 120 |

P902 Butcher's tong
Pinza charcutería
Pince à charcuterie



| REF | L cm | €/ u | |
|---------|----------|------|---|
| P902000 | 10,5 x 5 | 8,05 | 1 |

P389 Aluminium lobster cracker
Pinza para mariscos en aluminio
Casse-pattes en aluminium



| REF | L cm | €/ u | |
|---------|------|------|-----|
| P389000 | 14 | 4,85 | 144 |

14.11 Signs

Señalización
Signalization

P19117 Barrier with retractable belt

Poste con cinta retráctil
Poteau dérouleur à sangle

SS
Stainless steel
Pintado negro
Black-painted
Peint noir



| REF | H cm | Kg | €/ u | 📦 |
|--------|------|----|-------|---|
| P19117 | 90 | 7 | 77,30 | 2 |

P19114 Barrier with retractable belt

Poste con cinta retráctil
Poteau dérouleur à sangle

SS
Stainless steel

Mirror Polished.
Pulido brillante.
Polissage brillant.

Detachable head.
Cabezal removible.
Tête amovible.



| REF | Colour / Color / Couleur | H cm | L cm | Kg | €/ u | 📦 |
|---------|--------------------------|------|------|----|--------|---|
| P19114N | ● | 94 | 200 | 9 | 102,30 | 1 |
| P19114A | ● | 94 | 200 | 9 | 102,30 | 1 |
| P19114R | ● | 94 | 200 | 9 | 102,30 | 1 |

P19118 Information sign

Panel información
Panneau information

SS
Stainless steel

For barrier
Para poste
Pour poteau
P19.117



| REF | cm | €/ u | 📦 |
|--------|---------|-------|----|
| P19118 | 22 x 46 | 49,55 | 10 |

P19115 Spare head

Recambio cabezal
Rechange de sangle

SS
Stainless steel

For barrier
Para poste
Pour poteau
P19.114



| REF | Colour / Color / Couleur | L cm | €/ u | 📦 |
|---------|--------------------------|------|-------|----|
| P19115N | ● | 200 | 48,10 | 12 |
| P19115A | ● | 200 | 48,10 | 12 |
| P19115R | ● | 200 | 48,10 | 12 |

P19116 Information sign

Panel información
Panneau information

SS
Stainless steel

For barrier
Para poste
Pour poteau
P19.114



| REF | cm | €/ u | 📦 |
|--------|-----------|-------|----|
| P19116 | 21,8 x 32 | 54,30 | 10 |

P19100 St/Steel barrier

Poste separación acero inoxidable
Poteau acier inoxydable

SS
Stainless steel

P19100
Mirror Polished.
Pulido brillante.
Polissage brillant.

P19101
Golden coated.
Baño dorado.
Doré.

Belt not included
Cordón no incluido
Cordon non inclus

Ref. P19100

Ref. P19101



| REF | H cm | Kg | €/ u | 📦 |
|--------|------|------|--------|---|
| P19100 | 95 | 10,5 | 93,85 | 2 |
| P19101 | 100 | 10,5 | 104,75 | 2 |

P19105 Belt with chromium-plated ends

Cordón con ganchos cromados
Cordon à crochets chromés

Te
Textile

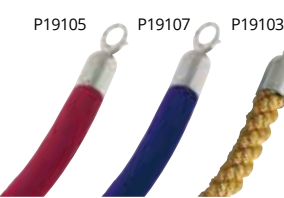

P19106 Belt with golden ends

Cordón con ganchos dorados
Cordon à crochets dorés

Te
Textile



| REF | Colour / Color / Couleur | L cm | €/ u | 📦 |
|--------|--------------------------|------|-------|----|
| P19105 | ● | 150 | 23,00 | 18 |
| P19107 | ● | 150 | 23,00 | 18 |
| P19103 | ● | 150 | 46,00 | 18 |

| REF | Colour / Color / Couleur | L cm | €/ u | 📦 |
|--------|--------------------------|------|-------|----|
| P19106 | ● | 150 | 23,00 | 18 |
| P19104 | ● | 150 | 49,35 | 18 |

Signs 14.11

Señalización
Signalization

Produced from special plastic completely anti-scratch material. Solid wood frame double-lacquered. Rain and sunproof. Writing-surfaces specially designed for using water based chalkmarkers.

Fabricadas con un material plástico especial que no se raya. Marcos de madera resistentes al agua y al sol. Pizarras especialmente diseñadas para el uso de tizas o rotuladores con base de agua.

Fabriqués avec un matériel plastique spécial anti-rayures. Cadres en bois massif. Résistants à la pluie et au soleil. Tableaux spécialement conçus pour l'utilisation des craies ou marqueurs avec base à eau.

P21000 / P21001 Caballete - Duo

Wo
Wood

PI
Plastic



| REF | W cm | H cm | €/ u | 📦 |
|--------|------|------|--------|---|
| P21000 | 75 | 135 | 225,50 | 1 |
| P21001 | 55 | 85 | 148,00 | 1 |

P21003 Caballete - Uno

Wo
Wood

PI
Plastic



| REF | W cm | H cm | €/ u | 📦 |
|--------|------|------|-------|---|
| P21003 | 55 | 85 | 79,80 | 1 |

P2100 Universal

Wo
Wood

PI
Plastic



| REF | W cm | H cm | €/ u | 📦 |
|--------|------|------|-------|---|
| P21005 | 50 | 60 | 34,90 | 5 |

P2101 Lucky

Wo
Wood

PI
Plastic

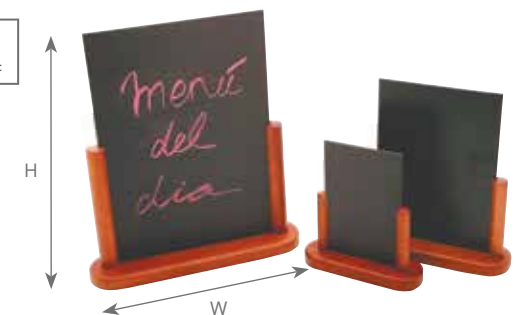

| REF | W cm | H cm | €/ u | 📦 |
|--------|------|------|-------|----|
| P21015 | 10 | 15 | 9,60 | 36 |
| P21016 | 15 | 21 | 11,40 | 24 |
| P21017 | 21 | 30 | 19,00 | 10 |

P2102 Basic

PI
Plastic

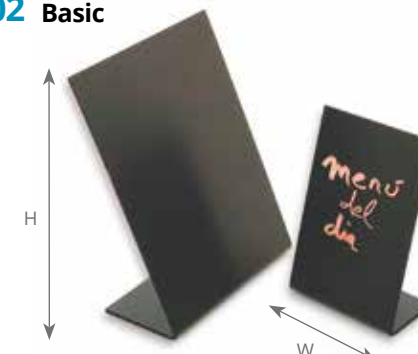

| REF | W cm | H cm | €/ u | 📦 |
|--------|------|------|-------|-----|
| P21027 | 10 | 15 | 6,70 | 200 |
| P21028 | 15 | 23 | 11,25 | 100 |

P21020-26 Chalkmarker

Marcador tiza
Marqueur

PI
Plastic



Widths 2-6 mm
Grueso 2-6 mm
Épaisseur 2-6 mm

| REF | Colour / Color / Couleur | €/ u | 📦 |
|--------|--------------------------|------|-----|
| P21020 | White / Blanco / Blanc | 6,75 | 500 |

15 Table service

Servicio de mesa
Arts de table



15.1 MINIATURES 454

MINIATURAS / MINIATURES

| | |
|---|-----|
| Stainless steel / Acero inoxidable / Acier inoxidable | 454 |
| Enamelled steel / Acero esmaltado / Acier émaillé | 458 |
| Cast aluminium / Aluminio de fundición / Fonte d'aluminium | 459 |
| Cast iron / Hierro fundido / Fonte émaillée | 460 |

15.2 TABLE PRESENTATION 462

PRESENTACIÓN DE MESA / PRÉSENTATION TABLE

| | |
|---|-----|
| Wood / Madera / Bois | 462 |
| Taco and sandwich tray / Tacos y bocadillos presentación Présentation de Tacos et sandwichs | 463 |
| Tin plates display / Llaunas presentación / Plateaux inox présentation | 464 |
| Slates / Pizarras / Ardoises | 466 |
| Natural bamboo / Bambú natural / Bambou naturel | 468 |
| Baskets and breadbaskets / Paneras y cestas / Paniers et corbeilles | 470 |
| Place mats / Manteles individuales / Sets de table | 478 |

15.3 TABLE SERVICE 479

SERVICIO DE MESA / SERVICE DE TABLE

| | |
|--|-----|
| Flared sauce cups / Salseras / Saucières | 479 |
| Table accessories / Complementos de mesa / Accessoires de table | 480 |
| Menu holders / Portamenús / Porte-menus | 484 |
| Food & table service / Servicio de mesa / Arts de table | 485 |

15.1 Stainless steel miniatures

Miniaturas acero inoxidable
Miniatures acier inoxydable

SS
Stainless
steel



P24714 Mini round frying pan

Mini sartén redonda
Mini poêle ronde

NEW!



| REF | Ø cm | H cm | €/u | 6 |
|--------|------|------|-------|---|
| P24714 | 12,0 | 3,5 | 15,20 | 6 |
| P24715 | 15,5 | 4,5 | 18,25 | 6 |

P24716 Mini round saucepan

Mini cazo redondo
Mini casserole ronde

NEW!



| REF | Ø cm | H cm | €/u | 6 |
|--------|------|------|-------|---|
| P24716 | 10,5 | 5 | 16,15 | 6 |
| P24717 | 12,0 | 6 | 19,35 | 6 |

P24718 Mini square frying pan

Mini sartén cuadrada
Mini poêle carrée

NEW!



| REF | W x D x H cm | €/u | 6 |
|--------|---------------|-------|---|
| P24718 | 12 x 12 x 3,5 | 18,35 | 6 |
| P24719 | 14 x 14 x 3,5 | 21,55 | 6 |

Stainless steel miniatures 15.1

Miniaturas acero inoxidable
Miniatures acier inoxydable

SS
Stainless
steel

P24706 Mini saucepan

Mini cazo
Mini casserole

NEW!



| REF | Ø cm | H cm | €/u | 6 |
|--------|------|------|------|----|
| P24706 | 7 | 4,5 | 4,75 | 12 |
| P24707 | 9 | 5,0 | 6,50 | 6 |

P24711 Mini saucepan. Copper color

Mini cazo. Color cobre
Mini casserole. Couleur cuivre

NEW!



| REF | Ø cm | H cm | €/u | 6 |
|--------|------|------|------|----|
| P24711 | 7 | 4,5 | 7,05 | 12 |
| P24712 | 9 | 5,0 | 9,00 | 6 |

P24708 Mini wok

Mini wok
Mini wok

NEW!



| REF | Ø cm | H cm | €/u | 6 |
|--------|------|------|------|---|
| P24708 | 10 | 3 | 3,50 | 6 |

P24713 Mini wok. Copper color

Mini wok. Color cobre
Mini wok. Couleur cuivre

NEW!



| REF | Ø cm | H cm | €/u | 6 |
|--------|------|------|------|---|
| P24713 | 10 | 3 | 6,45 | 6 |

P24704 Mini frying pan

Mini sartén
Mini poêle

NEW!



| REF | Ø cm | H cm | €/u | 6 |
|--------|------|------|------|---|
| P24704 | 11 | 3,0 | 6,40 | 6 |
| P24705 | 12 | 3,5 | 7,30 | 6 |

P24709 Mini frying pan. Copper color

Mini sartén. Color cobre
Mini poêle. Couleur cuivre

NEW!



| REF | Ø cm | H cm | €/u | 6 |
|--------|------|------|-------|---|
| P24709 | 11 | 3,0 | 9,45 | 6 |
| P24710 | 12 | 3,5 | 10,40 | 6 |

15.1 Stainless steel miniatures

Miniaturas acero inoxidable
Miniatures acier inoxydable



P24410 Mini rectangular roasting pan
Mini rustidera rectangular
Mini rôtissoire rectangulaire

NEW!



| REF | W x D x H cm | € / u | |
|--------|------------------|-------|----|
| P24410 | 14,5 x 9,5 x 7,5 | 6,05 | 12 |

P24411 Mini square roasting pan
Mini rustidera cuadrada
Mini rôtissoire carrée

NEW!



| REF | W x D x H cm | € / u | |
|--------|-------------------|-------|----|
| P24411 | 11,5 x 11,5 x 7,5 | 5,50 | 12 |

P2440 Mini bucket
Mini cubo
Mini seau



| REF | Ø cm | H cm | L | € / u | |
|--------|------|------|------|-------|----|
| P24407 | 7,5 | 6,5 | 0,15 | 3,45 | 72 |
| P24409 | 9,0 | 8,5 | 0,32 | 4,85 | 72 |

Stainless steel miniatures 15.1

Miniaturas acero inoxidable
Miniatures acier inoxydable



P24415 Serving cup
Vaso para servir
Tasse de service



NEW!



| REF | Ø cm | H cm | € / u | |
|--------|------|------|-------|----|
| P24415 | 8,5 | 8,5 | 3,30 | 12 |

P24412 Hammered serving cup
Vaso para servir hammered
Tasse de service martelée



NEW!



| REF | Ø cm | H cm | € / u | |
|--------|------|------|-------|----|
| P24412 | 8,5 | 8,5 | 4,10 | 12 |

P24413 Hammered serving cup. Copper color
Vaso para servir hammered. Color cobre
Tasse de service martelée Couleur cuivre



dishwasher

NEW!



| REF | Ø cm | H cm | € / u | |
|--------|------|------|-------|----|
| P24413 | 8,5 | 8,5 | 6,80 | 12 |

P24414 Hammered serving cup. Black color
Vaso para servir hammered. Color negro
Tasse de service martelée Couleur noire



dishwasher

NEW!



| REF | Ø cm | H cm | € / u | |
|--------|------|------|-------|----|
| P24414 | 8,5 | 8,5 | 6,80 | 12 |

15.1 Enamelled steel miniatures

Miniaturas acero esmaltado
Miniatures acier émaillé

ES
Enamelled
steel

P99801 Casserole with lid Cazuela con tapa Cocotte avec couvercle



NEW!



| REF | Ø cm | H cm | €/u | |
|---------|------|------|-------|---|
| P998010 | 10 | 6,0 | 14,95 | 1 |
| P998012 | 12 | 4,0 | 17,45 | 1 |
| P998014 | 14 | 4,5 | 19,90 | 1 |

P99901 Shallow casserole without lid Cazuela baja sin tapa Cocotte sans couvercle



NEW!



| REF | Ø cm | H cm | €/u | |
|---------|------|------|-------|---|
| P999012 | 12 | 6,5 | 9,95 | 1 |
| P999014 | 14 | 7,0 | 11,95 | 1 |

P995 Enamelled steel paella pan Paellera acero esmaltado Plat à paella acier émaillé



| REF | Ø cm | €/u | |
|---------|------|------|---|
| P995010 | 10 | 5,65 | 1 |
| P995016 | 15 | 6,65 | 1 |

P997 Deep enamelled fry pan with handles Sartén honda esmaltada con asas Poêle haute avec anses



| REF | Ø cm | Lts | €/u | |
|---------|------|-----|------|---|
| P997014 | 14 | 0,4 | 6,00 | 1 |
| P997016 | 16 | 0,5 | 6,50 | 1 |

Cast aluminium miniatures 15.1

Miniaturas aluminio de fundición
Miniatures fonte d'aluminium

CA
Cast
Aluminium

Made of cast aluminium with high resistance to deformation and excellent thermal performance.

Non-stick interior coating.

Fabricada en aluminio de fundición de gran resistencia a la deformación y con excelentes prestaciones térmicas.

Revestimiento interior antiadherente.

Fabriqué en fonte d'aluminium très résistante à la déformation et doté d'excellentes performances techniques.

Revêtement intérieur antiadhésif.

P151100 Mini black casserole with lid Mini cazuela negra con tapa Mini cocotte noire avec couvercle



NEW!

Wooden base included
Base de madera incluida.
Base en bois incluse



| REF | Ø cm | H cm | €/u | |
|---------|------|------|-------|---|
| P151100 | 10 | 5 | 21,55 | 1 |

P151200 Mini black oval casserole with lid Mini cazuela oval negra con tapa Mini cocotte ovale noire avec couvercle



NEW!

Wooden base included
Base de madera incluida.
Base en bois incluse



| REF | W x D x H cm | €/u | |
|---------|---------------|-------|---|
| P151200 | 13 x 10,5 x 5 | 22,95 | 1 |

P151300 Mini white casserole with lid Mini cazuela blanca con tapa Mini cocotte blanche avec couvercle



NEW!

Wooden base included
Base de madera incluida.
Base en bois incluse



| REF | Ø cm | H cm | €/u | |
|---------|------|------|-------|---|
| P151300 | 10 | 5 | 21,55 | 1 |

P151400 Mini white oval casserole with lid Mini cazuela oval blanca con tapa Mini cocotte ovale blanche avec couvercle



NEW!

Wooden base included
Base de madera incluida.
Base en bois incluse



| REF | W x D x H cm | €/u | |
|---------|---------------|-------|---|
| P151400 | 13 x 10,5 x 5 | 22,95 | 1 |

P141 Shallow casserole without lid Cazuela baja sin tapa Cocotte sans couvercle



| REF | Ø cm | H cm | €/u | |
|---------|------|------|-------|---|
| P141014 | 14 | 4,0 | 28,35 | 1 |
| P141016 | 16 | 5,0 | 34,75 | 1 |
| P141020 | 20 | 5,5 | 37,60 | 1 |

P151 Deep casserole without lid Cazuela alta sin tapa Braiseuse sans couvercle

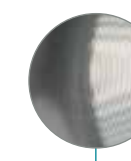

Ground base
Fondo torneado
Fond dressé



| REF | Ø cm | H cm | €/u | |
|---------|------|------|-------|---|
| P151012 | 12 | 8,5 | 30,00 | 1 |
| P151014 | 14 | 8,5 | 36,75 | 1 |
| P151016 | 16 | 8,0 | 38,15 | 1 |

15.1 Cast iron miniatures

Miniaturas hierro fundido
Miniatures fonte émaillée



Enamelled cast iron miniatures perfect for individual service and presentations.

Miniaturas en hierro fundido y esmaltado interior, perfectas para servicio individual y presentación.

Miniatures en fonte émaillée (à l'intérieur) idéales pour le service individuel et la présentation.



P23500 Mini fry pan
Mini sartén
Mini poêle ronde



| REF | Ø cm | L cm | H cm | €/u | 📦 |
|--------|------|------|------|------|----|
| P23500 | 10,5 | 16 | 2,6 | 6,60 | 12 |

P23501 Mini fry pan
Mini sartén
Mini poêle ronde



| REF | Ø cm | L cm | H cm | €/u | 📦 |
|--------|------|------|------|-------|----|
| P23501 | 13,5 | 21 | 2,5 | 10,35 | 12 |

P23502 Mini deep fry pan
Mini sartén alta
Mini poêle ronde haute



| REF | Ø cm | L cm | H cm | €/u | 📦 |
|--------|------|------|------|-------|----|
| P23502 | 14 | 23,5 | 3,8 | 15,50 | 12 |

P23503 Mini squared fry pan
Mini sartén cuadrada
Mini poêle carrée



| REF | W x D x H cm | L cm | €/u | 📦 |
|--------|-------------------|------|-------|----|
| P23503 | 13,6 x 13,6 x 3,6 | 23,3 | 16,75 | 12 |

Cast iron miniatures 15.1

Miniaturas hierro fundido
Miniatures fonte émaillée



P23504 Mini oblong fry pan
Mini sartén rectangular
Mini poêle rectangulaire



| REF | W x D x H cm | L cm | €/u | 📦 |
|--------|-------------------|------|------|----|
| P23504 | 12,7 x 10,5 x 2,5 | 18 | 9,40 | 12 |

P23508 Oval casserole
Cacerola oval
Mini casserole ovale



| REF | W x D x H cm | Lts | €/u | 📦 |
|--------|-------------------|------|-------|---|
| P23508 | 21,5 x 15,5 x 6,5 | 0,60 | 25,30 | 8 |

P23505 Mini round casserole with lid
Mini cacerola con tapa
Mini cocotte avec couvercle



| REF | Ø cm | L cm | H cm | Lts | €/u | 📦 |
|--------|------|------|------|------|-------|----|
| P23505 | 10 | 13 | 7,5 | 0,20 | 20,30 | 12 |

P23507 High round casserole with lid
Cacerola alta con tapa
Cocotte haute avec couvercle



| REF | Ø cm | H cm | Lts | €/u | 📦 |
|--------|------|------|------|-------|---|
| P23507 | 14 | 9,5 | 0,70 | 31,00 | 8 |

P23506 Mini oval pan with lid
Mini fuente oval con tapa
Mini plateau ovale avec couvercle



| REF | W x D x H cm | L cm | €/u | 📦 |
|--------|--------------|------|-------|----|
| P23506 | 12 x 8 x 5 | 15,5 | 11,70 | 12 |

P23509 High mini oval pan with lid
Mini fuente oval alta con tapa
Mini plateau ovale haut avec couvercle



| REF | W x D x H cm | Lts | €/u | 📦 |
|--------|------------------|------|-------|----|
| P23509 | 12,5 x 9,3 x 7,5 | 0,25 | 30,95 | 12 |

15.2 Wood serving boards

Tablas de madera
Planches en bois



P41008 Wood serving boards
Tablas de madera
Planches en bois

NEW!



| REF | cm | €/u | |
|--------|-----------|-------|---|
| P41008 | 28 x 30,5 | 17,45 | 1 |

P41009 Wood serving boards
Tablas de madera
Planches en bois

NEW!



| REF | cm | €/u | |
|--------|-------------|-------|---|
| P41009 | 40,5 x 30,5 | 21,40 | 1 |

P41010 Wood serving boards
Tablas de madera
Planches en bois

NEW!



| REF | cm | €/u | |
|--------|-------------|-------|---|
| P41010 | 51,8 x 20,3 | 20,15 | 1 |

P41011 Wood serving boards
Tablas de madera
Planches en bois

NEW!



| REF | cm | €/u | |
|--------|-----------|-------|---|
| P41011 | 36 x 17,5 | 22,65 | 1 |

Taco and sandwich tray 15.2

Tacos y bocadillos presentación
Présentation de Tacos et sandwiches



P41001 Taco tray. 2-3 compartments
Soporte tacos. 2-3 compartimentos
Plateau à Tacos 2-3 compartiments



| REF | W x D x H cm | €/u | |
|--------|---------------|------|---|
| P41001 | 21 x 10,2 x 5 | 6,70 | 1 |

P41002 Taco tray. 4-5 compartments
Soporte tacos. 4-5 compartimentos
Plateau à Tacos 4-5 compartiments



| REF | W x D x H cm | €/u | |
|--------|---------------|------|---|
| P41002 | 36 x 10,2 x 5 | 9,85 | 1 |

P41004 Taco tray with wooden base
Soporte tacos con base de madera
Plateau à tacos avec base en bois



| REF | W x D x H cm | €/u | |
|--------|-----------------|-------|---|
| P41004 | 44 x 10,8 x 6,5 | 27,80 | 1 |

P. 479

Ramekin / Sauce container
Recipiente para salsas
Récipient pour sauces



P41003 Sandwich tray. 7 compartments
Soporte bocadillos. 7 compartimentos
Plateau à sandwiches. 7 compartiments



| REF | W x D x H cm | €/u | |
|--------|-----------------|-------|---|
| P41003 | 44 x 10,8 x 6,5 | 21,50 | 1 |

15.2 Tin plates display

Llaunas presentación
Plateaux inox présentation



P296415 Stainless steel tray with handles

Llauna inox con asas
Plaque inox avec anses



| REF | Base cm | Total W x D x H cm | €/u | |
|---------|-----------|--------------------|-------|---|
| P296415 | 22 x 14 | 25,5 x 14 x 1,5 | 19,00 | 1 |
| P296430 | 22 x 14 | 25,5 x 14 x 3 | 20,30 | 1 |
| P296515 | 26,5 x 23 | 30 x 23 x 1,5 | 22,05 | 1 |
| P296530 | 26,5 x 23 | 30 x 23 x 3 | 23,50 | 1 |
| P296615 | 32 x 24 | 35,5 x 24 x 1,5 | 23,60 | 1 |
| P296630 | 32 x 24 | 35,5 x 24 x 3 | 25,20 | 1 |
| P296715 | 32 x 18 | 35,5 x 18 x 1,5 | 21,55 | 1 |
| P296730 | 32 x 18 | 35,5 x 18 x 3 | 23,00 | 1 |

P296300 Cork base

Base de corcho
Base en liège



dishwasher

| REF | W x D x H cm | Suitable for Compatible con Adaptable pour | €/u | |
|---------|---------------|--|-------|---|
| P296300 | 30 x 19 x 3 | P296415 - P296430 | 20,50 | 1 |
| P296400 | 34,5 x 28 x 3 | P296515 - P296530 | 30,65 | 1 |
| P296500 | 40 x 29 x 3 | P296615 - P296630 | 34,75 | 1 |
| P296600 | 40 x 23 x 3 | P296715 - P296730 | 30,00 | 1 |

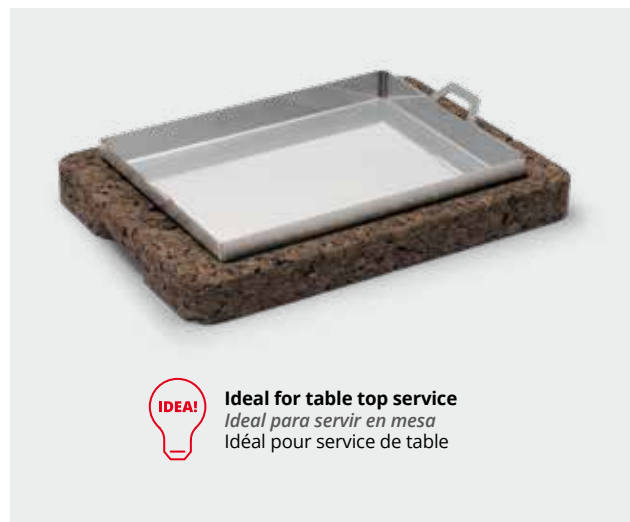

IDEA! Ideal for table top service
Ideal para servir en mesa
Idéal pour service de table

Tin plates display 15.2

Llaunas presentación
Plateaux inox présentation

P29680 Stainless steel presentation spatula

Pala presentación en inox
Pelle de présentation en inox



| REF | Base cm | Total W x D x H cm | €/u | |
|--------|---------|--------------------|-------|---|
| P29680 | 23 x 16 | 38,6 x 16 x 11,5 | 20,70 | 1 |

P2965001 Triangular tray

Llauna triangular
Plaque triangulaire



| REF | W x D x H cm | €/u | |
|----------|---------------|-------|---|
| P2965001 | 29 x 29 x 1,5 | 26,95 | 1 |

P29610 Sheet pan with wooden tray with handle

Llauna bandeja presentación rectangular con mango
Plateau de présentation avec manche



| REF | Llauna W x D x H cm | Total W x D x H cm | €/u | |
|--------|---------------------|--------------------|-------|---|
| P29610 | 22 x 14 x 2 | 34 x 18 x 3 | 39,35 | 6 |

P29600 Sheet pan with wooden tray

Llauna bandeja presentación rectangular
Plateau de présentation



| REF | Llauna W x D x H cm | Total W x D x H cm | €/u | |
|--------|---------------------|--------------------|-------|---|
| P29600 | 29,5 x 19,5 x 2 | 33 x 23 x 3 | 40,05 | 6 |

P1950 1/1 GN sheet pan

Llauna bandeja gastronorm 1/1 presentación
Plateau GN 1/1 de présentation



GN 1/1



| REF | Llauna W x D x H cm | Total L cm | €/u | |
|---------|---------------------|------------|-------|---|
| P195000 | 48 x 32 x 2 | 52,5 | 46,80 | 6 |

P296 Round sheet pan with wooden tray

Llauna bandeja presentación redonda
Plateau rond de présentation



IDEA! Ideal for table top service
Ideal para servir en mesa
Idéal pour service de table

| REF | Llauna Ø cm | H cm | Total L cm | H cm | €/u | |
|--------|-------------|------|------------|------|-------|---|
| P29620 | 20 | 4,5 | 31 | 5,5 | 39,65 | 6 |
| P29630 | 26 | 4,5 | 37 | 5,5 | 48,55 | 6 |

15.2 Slates

Pizarras
Ardoises



SI
Slate

Wo
Wood



dishwasher

Natural, elegant and exclusive presentation of cold or hot plates.

Presentación natural, elegante y exclusiva de platos fríos o calientes.

Présentation naturelle, élégante et exclusive de plats froids ou chauds.

P28600 Slate and acacia board

Tabla pizarra y acacia
Plateau ardoise et bois



| REF | W x D x H cm | € / u | |
|--------|---------------|-------|---|
| P28600 | 33 x 23 x 1,5 | 22,25 | 1 |

P28610 Slate and acacia board

Tabla pizarra y acacia
Plateau ardoise et bois



| REF | W x D x H cm | L cm | € / u | |
|--------|---------------|------|-------|---|
| P28610 | 26 x 18 x 1,5 | 34 | 18,50 | 1 |

P28620 Slate and acacia board

Tabla pizarra y acacia
Plateau ardoise et bois



| REF | Ø cm | L cm | H cm | € / u | |
|--------|------|------|------|-------|---|
| P28620 | 21,0 | 31 | 1,5 | 18,05 | 1 |
| P28621 | 26,5 | 37 | 1,5 | 22,55 | 1 |

See products on

Ver productos en / Voir produits en page

P. 92

Display tray

Bandeja presentación
Plateau présentation



Slates 15.2

Pizarras
Ardoises

SI
Slate

P28202 Slate serving tray

Pizarra presentación
Ardoise presentation

BEST
SELLER



Polished edges
Cantos pulidos
Coins biseautés

Rubber feet
Pies espumados
Pieds mousse

4-5 mm
Thickness
Espesor
Epaisseur



| REF | cm | € / u | |
|--------|---------|-------|----|
| P28202 | 20 x 20 | 3,85 | 24 |
| P28252 | 25 x 25 | 6,15 | 16 |
| P28303 | 30 x 30 | 8,15 | 12 |
| P28302 | 30 x 20 | 5,95 | 16 |
| P28403 | 40 x 30 | 10,70 | 10 |

P28501 Slate serving tray

Pizarra presentación
Ardoise presentation



| REF | cm | € / u | |
|--------|---------|-------|---|
| P28501 | 25 x 25 | 6,15 | 1 |
| P28502 | 30 x 30 | 8,15 | 1 |
| P28503 | 30 x 20 | 5,80 | 1 |
| P28504 | 40 x 30 | 10,50 | 1 |

P28505 Slate serving tray

Pizarra presentación
Ardoise presentation



| REF | Ø cm | € / u | |
|--------|------|-------|---|
| P28505 | 20 | 5,10 | 1 |
| P28506 | 30 | 7,75 | 1 |

Natural edges
Cantos naturales
Coins naturels

5-6 mm
Thickness
Espesor
Epaisseur

Rubber feet
Pies espumados
Pieds mousse

Rough surface
Superficie rústica
Surface rustique

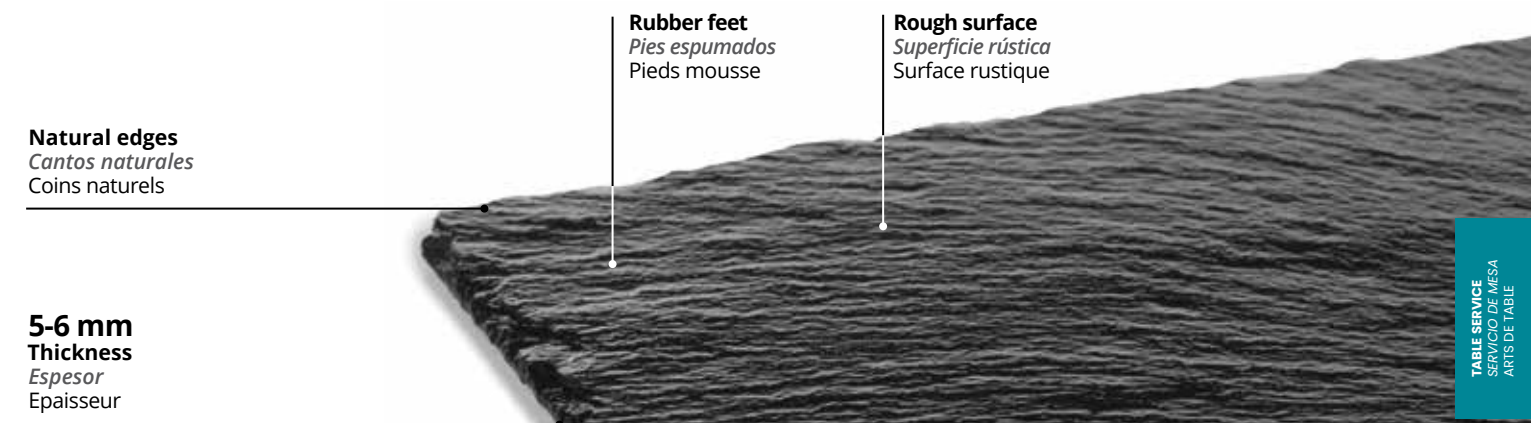

15.2 Natural bamboo

Bambú natural
Bambou naturel



NATURAL FIBERS

Natural bamboo presentation range for the most demanding hotels and restaurants.

Gama presentación bambú natural para los más exigentes.

Gamme de présentation bambou naturel plus exigeants.



P10051 Bamboo sushi board
Tabla bambú presentación sushi
Planche bambou présentation sushi



| REF | W x D x H cm | €/ u | |
|---------|--------------|-------|----|
| P100511 | 24 x 15 x 3 | 14,15 | 24 |
| P100512 | 27 x 18 x 3 | 17,65 | 24 |

P10052 Curved bamboo sushi board
Tabla curvada bambú sushi
Planche incurvée bambou présentation sushi



| REF | W x D x H cm | €/ u | |
|---------|---------------|-------|----|
| P100520 | 21 x 12 x 2,5 | 12,10 | 36 |
| P100521 | 24 x 15 x 3 | 14,80 | 24 |
| P100522 | 27 x 18 x 3 | 18,30 | 24 |

P10060 Sushi boat presentation
Barco presentación sushi
Bateau présentation sushi



| REF | W x D x H cm | €/ u | |
|---------|----------------|--------|---|
| P100600 | 50 x 20 x 31 | 115,25 | 6 |
| P100601 | 70 x 25,5 x 45 | 153,85 | 8 |

Natural bamboo 15.2

Bambú natural
Bambou naturel



P10054 Round bamboo steamer
Vaporeira bambú redonda
Cuit vapeur bambou rond



Without lid
Sin tapa
Sans couvercle

| REF | Ø cm | H cm | €/ u | |
|---------|------|------|-------|-----|
| P100540 | 10 | 4,0 | 4,50 | 50 |
| P100541 | 13 | 5,0 | 6,70 | 224 |
| P100542 | 15 | 5,0 | 6,85 | 144 |
| P100543 | 21 | 5,0 | 8,45 | 72 |
| P100544 | 27 | 5,5 | 12,10 | 44 |

P10055 Round steamer lid
Tapa vaporeira redonda
Couvercle cuit vapeur rond



| REF | Ø cm | H cm | €/ u | |
|---------|------|------|-------|-----|
| P100550 | 10 | 3,0 | 4,30 | 500 |
| P100551 | 13 | 3,5 | 6,00 | 272 |
| P100552 | 15 | 3,5 | 6,45 | 204 |
| P100553 | 21 | 4,0 | 7,70 | 102 |
| P100554 | 27 | 4,0 | 11,35 | 60 |

P10053 Sushi rectangular tray
Bandeja rectangular presentación sushi
Plateau rectangulaire présentation sushi



| REF | W x D x H cm | €/ u | |
|---------|---------------|-------|---|
| P100530 | 33 x 22,5 x 8 | 43,70 | 6 |
| P100531 | 42 x 32 x 8,5 | 48,30 | 6 |

P10057 Bamboo tong
Pinza bambú
Pince bambou



| REF | L cm | €/ u | |
|---------|------|------|-----|
| P100570 | 20,0 | 1,60 | 780 |
| P100571 | 25,5 | 1,85 | 504 |
| P100572 | 30,0 | 2,10 | 444 |

15.2 Baskets and breadbaskets

Paneras y cestas
Paniers et corbeilles



Mt
Metal

P876001 Metal cone basket
Cesta cono metal
Panier métal cône

Mt
Metal



| REF | cm | H cm | €/u | |
|---------|---------|------|------|---|
| P876001 | 13 x 13 | 18 | 5,95 | 1 |

P876002 Metal cone basket 1 ramekin
Cesta cono metal 1 ramekin
Panier métal cône 1 ramequin

Mt
Metal



Ramekin not included
Ramekin no incluido
Ramequin non inclus



Ramekin compatible
Compatible con ramekin
Compatible ramequin
P41007, P41013, P41014,
P41016, P41017, P41019 y
P41020

| REF | cm | H cm | €/u | |
|---------|---------|------|------|---|
| P876002 | 19 x 13 | 18 | 6,95 | 1 |

P876003 Metal cone basket 2 ramekins
Cesta cono metal 2 ramekines
Panier métal cône 2 ramequins

Mt
Metal



Ramekin not included
Ramekin no incluido
Ramequin non inclus

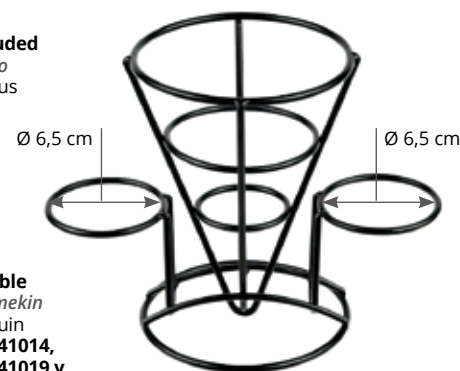

Ramekin compatible
Compatible con ramekin
Compatible ramequin
P41007, P41013, P41014,
P41016, P41017, P41019 y
P41020

| REF | cm | H cm | €/u | |
|---------|---------|------|------|---|
| P876003 | 25 x 13 | 18 | 7,95 | 1 |

See products on
Ver productos en / Voir produits en page

P. 479

Ramekins
Ramekins
Ramequins



Baskets and breadbaskets 15.2

Paneras y cestas
Paniers et corbeilles

Mt
Metal

P591001 Round metal basket
Cesta metal redonda
Panier métal rond

Mt
Metal



| REF | Ø cm | H cm | €/u | |
|---------|------|------|-------|---|
| P591001 | 26,5 | 5 | 13,90 | 1 |

P591002 Oval metal basket
Cesta metal ovalada
Panier métal ovale

Mt
Metal



| REF | W x D x H cm | €/u | |
|---------|-----------------|-------|---|
| P591002 | 22,5 x 15 x 4,5 | 12,25 | 1 |

P591003 Rectangular metal basket
Cesta metal rectangular
Panier métal rectangulaire

Mt
Metal



| REF | W x D x H cm | €/u | |
|---------|---------------|-------|---|
| P591003 | 23 x 10 x 4,5 | 11,85 | 1 |

P591004 Rectangular metal basket
Cesta metal rectangular
Panier métal rectangulaire

Mt
Metal



| REF | W x D x H cm | €/u | |
|---------|-----------------|-------|---|
| P591004 | 23 x 17,5 x 4,5 | 13,90 | 1 |

P591005 Round metal basket
Cesta metal redonda
Panier métal rond

Mt
Metal



| REF | Ø cm | H cm | €/u | |
|---------|------|------|-------|---|
| P591005 | 20,5 | 13 | 14,95 | 1 |

Baskets and breadbaskets 15.2

Paneras y cestas
Paniers et corbeilles



P100816 Brown bread basket
Cesta pan marrón
Corbeille à pain marron

Washable
Se puede lavar
Peuvent se laver



P100807

| REF | W x D x H cm | €/u | 📦 |
|---------|------------------|-------|----|
| P100816 | 13,0 x 13,0 x 15 | 7,35 | 12 |
| P100807 | 17,5 x 17,5 x 15 | 10,10 | 12 |
| P100836 | 26,5 x 26,5 x 12 | 12,85 | 12 |

P100808 Grey bread basket
Cesta pan gris
Corbeille à pain gris

Washable
Se puede lavar
Peuvent se laver



P100808

P100838

| REF | W x D x H cm | €/u | 📦 |
|---------|------------------|-------|----|
| P100808 | 13,0 x 13,0 x 15 | 7,35 | 12 |
| P100827 | 17,5 x 17,5 x 15 | 10,10 | 12 |
| P100838 | 26,5 x 26,5 x 12 | 12,85 | 12 |

P100817 Black bread basket
Cesta pan negra
Corbeille à pain noir

Washable
Se puede lavar
Peuvent se laver



P100826

| REF | W x D x H cm | €/u | 📦 |
|---------|------------------|-------|----|
| P100817 | 13,0 x 13,0 x 15 | 7,35 | 12 |
| P100826 | 17,5 x 17,5 x 15 | 10,10 | 12 |
| P100837 | 26,5 x 26,5 x 12 | 12,85 | 12 |



15.2 Baskets and breadbaskets

Paneras y cestas
Paniers et corbeilles



P100740 Bread basket
Cesta pan
Corbeille à pain



P100740

| REF | W x D x H cm | €/u | |
|---------|----------------|-------|----|
| P100740 | 29 x 29 x 47,5 | 65,10 | 12 |

P100741 Bread basket
Cesta pan
Corbeille à pain



P100741

| REF | W x D x H cm | €/u | |
|---------|-------------------|-------|---|
| P100741 | 36 x 30 x 21 / 39 | 48,60 | 6 |
| P100742 | Ø 29 x 21 / 39 | 48,60 | 6 |



P100742

P100780 Bread basket
Cesta pan
Corbeille à pain



P100780

| REF | Ø cm | H cm | €/u | |
|---------|------|------|-------|----|
| P100780 | 35 | 35 | 37,25 | 12 |

P10075 Slated bread basket
Cesta redonda inclinada
Corbeille ronde inclinée



| REF | Ø cm | H cm | €/u | |
|---------|------|---------|-------|---|
| P100754 | 36 | 10 / 20 | 24,10 | 6 |
| P100755 | 40 | 13 / 23 | 30,95 | 6 |

P10076 Slated rectangular basket
Cesta rectangular inclinada
Corbeille rectangulaire inclinée



| REF | W x D x H cm | €/u | |
|---------|------------------|-------|----|
| P100760 | 40 x 28 x 6 / 10 | 30,45 | 12 |
| P100761 | 58 x 38 x 8 / 12 | 49,25 | 6 |

P10077 Two compartment rectangular basket
Cesta rectangular dos compartimentos
Corbeille rectangulaire deux compartiments



| REF | W x D x H cm | €/u | |
|---------|---------------------|-------|---|
| P100770 | 49 x 31 x 10 / 14,3 | 42,50 | 6 |

Baskets and breadbaskets 15.2

Paneras y cestas
Paniers et corbeilles



P10079 Round basket
Cesta redonda
Corbeille ronde



| REF | Ø cm | H cm | €/u | |
|---------|------|------|------|----|
| P100792 | 24 | 5,5 | 9,45 | 60 |

P10080 Round basket
Cesta redonda
Corbeille ronde



P100804

P100803

P100805

| REF | Ø cm | H cm | €/u | |
|---------|------|------|-------|----|
| P100803 | 18 | 6,0 | 7,75 | 48 |
| P100804 | 23 | 6,0 | 10,40 | 48 |
| P100805 | 25 | 6,0 | 11,55 | 48 |

P10081 Round basket
Cesta redonda
Corbeille ronde

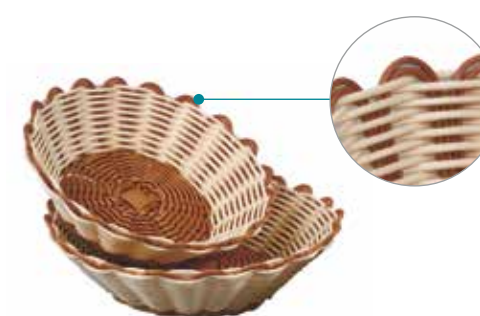

| REF | Ø cm | H cm | €/u | |
|---------|------|------|------|----|
| P100813 | 18,5 | 6,0 | 5,20 | 84 |
| P100814 | 23,0 | 6,0 | 6,65 | 84 |

P10082 Round basket
Cesta redonda
Corbeille ronde

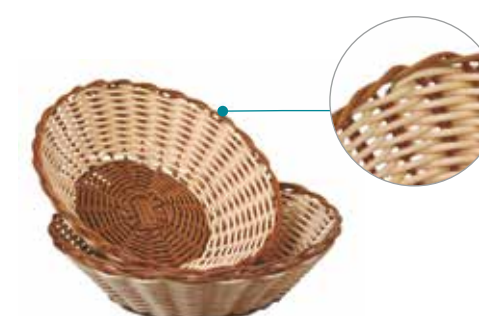

| REF | Ø cm | H cm | €/u | |
|---------|------|------|------|----|
| P100820 | 18,5 | 6,0 | 5,20 | 84 |
| P100821 | 23,0 | 6,0 | 6,65 | 84 |

P10090 Oval basket
Cesta oval
Corbeille ovale



| REF | W x D x H cm | €/u | |
|---------|-----------------|-------|----|
| P100900 | 30 x 23,5 x 7,5 | 10,40 | 36 |

15.2 Baskets and breadbaskets

Paneras y cestas
Paniers et corbeilles

PP
Polypropylene

P10084 Rectangular basket
Cesta rectangular
Corbeille rectangulaire



| REF | W x D x H cm | €/u | |
|---------|---------------|------|----|
| P100840 | 21,5 x 18 x 8 | 9,45 | 84 |
| P100841 | 26 x 20 x 7,5 | 8,45 | 48 |

P10085 Rectangular basket
Cesta rectangular
Corbeille rectangulaire



| REF | W x D x H cm | €/u | |
|---------|---------------|-------|----|
| P100851 | 40 x 28,5 x 7 | 22,45 | 24 |

P10086 Rectangular basket
Cesta rectangular
Corbeille rectangulaire



| REF | W x D x H cm | €/u | |
|---------|--------------|-------|----|
| P100860 | 37 x 27 x 7 | 19,85 | 24 |
| P100861 | 46 x 34 x 7 | 26,90 | 24 |
| P100862 | 46 x 34 x 12 | 32,30 | 12 |

P10087 Rectangular basket
Cesta rectangular
Corbeille rectangulaire



| REF | W x D x H cm | €/u | |
|---------|--------------|-------|----|
| P100871 | 42 x 30 x 7 | 26,90 | 24 |

P10088 Oval basket
Cesta oval
Corbeille ovale



| REF | W x D x H cm | €/u | |
|---------|-----------------|------|----|
| P100880 | 18 x 12 x 6,5 | 5,85 | 60 |
| P100881 | 23,5 x 15 x 7 | 7,30 | 60 |
| P100882 | 28 x 14,5 x 7,5 | 9,10 | 36 |

P10089 Oval basket
Cesta oval
Corbeille ovale



| REF | W x D x H cm | €/u | |
|---------|--------------|-------|----|
| P100890 | 19 x 13 x 7 | 6,90 | 48 |
| P100891 | 25 x 15 x 8 | 9,45 | 60 |
| P100892 | 29 x 19 x 10 | 10,65 | 60 |

Baskets and breadbaskets 15.2

Paneras y cestas
Paniers et corbeilles

PP
Polypropylene

P10093 Cutlery dispenser
Cesta para cubiertos
Corbeille à couverts



| REF | W x D x H cm | €/u | |
|---------|--------------|------|----|
| P100931 | 30 x 11 x 7 | 9,50 | 96 |
| P100932 | 30 x 11 x 7 | 9,50 | 96 |

P10094 Cutlery dispenser
Cesta para cubiertos
Corbeille à couverts



| REF | Ø cm | H cm | €/u | |
|---------|------|------|------|----|
| P100940 | 13 | 14 | 7,75 | 36 |

P10095 Rectangular buffet basket
Cesta buffet rectangular
Corbeille rectangulaire buffet

PE
Polyethylene

PC
Polycarbonate

GN 1/1



* Lid
Tapa
Couvercle

| REF | cm | Total H cm | Base H cm | €/u | |
|----------|-----------|------------|-----------|-------|----|
| P100950 | 53 x 31,5 | 26,0 | 8,5 | 38,00 | 12 |
| P100951 | 53 x 31,5 | 26,0 | 8,5 | 38,00 | 12 |
| P100955* | | | | 70,60 | 6 |

P10096 Round buffet basket
Cesta buffet redonda
Corbeille ronde buffet

PE
Polyethylene

PC
Polycarbonate



* Lid
Tapa
Couvercle

| REF | Ø cm | H cm | €/u | |
|----------|------|------|-------|----|
| P100960 | 40 | 30 | 24,70 | 24 |
| P100965* | | | 37,35 | 6 |

15.2 Place mats

Manteles individuales
Sets de table

PVC

Place mats made of PVC + polyester.
To clean please use a damp sponge or cloth.

Manteles individuales fabricados en PVC + poliéster. Para su limpieza se aconseja usar una esponja o trapo húmedo.

Sets de table fabriqués en PVC + polyester.
Nettoyer à l'aide d'une éponge ou un chiffon humide.

P92605 DECO place mats
Manteles individuales DECO
Sets de table DECO

PVC

| REF | cm | €/ PACK 6u |  |
|---------|---------|------------|---|
| P926051 | 45 x 30 | 17,90 | 20 |
| P926052 | 45 x 30 | 17,90 | 20 |
| P926053 | 45 x 30 | 17,90 | 20 |

Price / Precio / Prix : Pack 6 u.

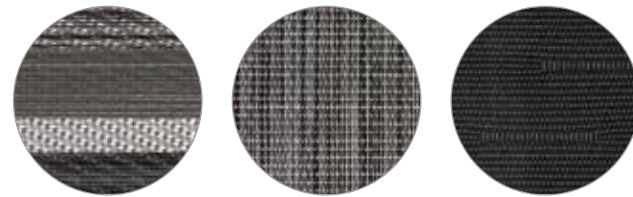

Brown&Black Lines
Líneas marrones-negras
Lignes marrons et noirs
P926051

Brown&Black
Marrón-negro
Marron et noir
P926052

Black
Negro
Noir
P926053

P9260 Place mat fine band
Mantel individual trama fina
Set de table maille fine

| REF | cm | €/ u |  |
|---------|---------|-------|---|
| P926006 | 45 x 30 | 17,90 | 20 |
| P926007 | 45 x 30 | 17,90 | 20 |
| P926008 | 45 x 30 | 17,90 | 20 |
| P926009 | 45 x 30 | 17,90 | 20 |



Brown
Marrón
Marron
P926006



Coffee
Café
Café
P926007



Black&White
Negro-Blanco
Noir et blanc
P926008

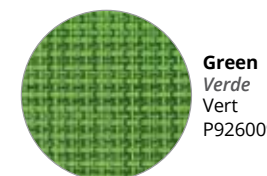

Green
Verde
Vert
P926009

P926 Place mat wide band
Mantel individual trama gruesa
Set de table maille épaisse

| REF | cm | €/ u |  |
|---------|---------|-------|---|
| P926002 | 45 x 30 | 18,30 | 20 |
| P926003 | 45 x 30 | 18,30 | 20 |
| P926004 | 45 x 30 | 18,30 | 20 |
| P926005 | 45 x 30 | 18,30 | 20 |
| P926010 | 45 x 30 | 17,90 | 20 |
| P926011 | 45 x 30 | 17,90 | 20 |
| P926012 | 45 x 30 | 17,90 | 20 |



Orange
Naranja
P926002



Brown&Silver
Marrón-Plata
Marron et Argent
P926010



Burgundy
Burdeos
Bordeaux
P926003



Brown&Gold
Marrón-Dorado
Marron et Doré
P926011

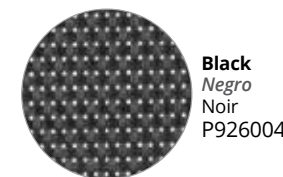

Black
Negro
Noir
P926004



Silver
Plateado
Argent
P926012



Brown&Black
Marrón-Negro
Marron et noir
P926005

Flared sauce cups 15.3

Salseras
Saucières

P4100 Ramekin / Sauce container
Recipiente para salsas
Récipient pour sauces

SS
Stainless steel

NEW!



Price / Precio / Prix : Pack 12 u.

| REF | Ø cm | H cm | ml | €/ PACK 12u |  |
|--------|------|------|-----|-------------|---|
| P41005 | 6,2 | 2,75 | 45 | 5,90 | 12 |
| P41006 | 5,8 | 4,50 | 75 | 6,65 | 12 |
| P41007 | 7,4 | 5,20 | 135 | 13,10 | 12 |

P4101 Ramekin / Sauce container
Recipiente para salsas
Récipient pour sauces

PET

NEW!



Price / Precio / Prix : Pack 12 u.

| REF | | Ø cm | H cm | ml | €/ PACK 12u |  |
|--------|--------------|------|------|----|-------------|---|
| P41012 | white | 6,0 | 3,5 | 45 | 8,85 | 12 |
| P41013 | blanco | 7,0 | 3,5 | 60 | 10,90 | 12 |
| P41014 | blanc | 7,5 | 4,0 | 90 | 12,95 | 12 |
| P41015 | black | 6,0 | 3,5 | 45 | 8,85 | 12 |
| P41016 | negro | 7,0 | 3,5 | 60 | 10,90 | 12 |
| P41017 | noir | 7,5 | 4,0 | 90 | 12,95 | 12 |
| P41018 | transparent | 6,0 | 3,5 | 45 | 8,85 | 12 |
| P41019 | transparente | 7,0 | 3,5 | 60 | 10,90 | 12 |
| P41020 | transparent | 7,5 | 4,0 | 90 | 12,95 | 12 |

P623 Snack bowl set or sauce bowl set
Portasalados o portasalzas
Ensemble bols pour snacks ou sauces

SS
Stainless steel



| REF | UNI. | Ø cm/u | ml/u | €/ u |  |
|---------|------|--------|------|-------|---|
| P623003 | 3 | 9 | 200 | 49,45 | 25 |

P333 Gravy boat
Salsera
Saucière

SS
Stainless steel



| REF | L | €/ u |  |
|---------|------|-------|---|
| P333010 | 0,10 | 6,45 | 72 |
| P333020 | 0,20 | 10,35 | 36 |
| P333035 | 0,35 | 11,80 | 24 |

15.3 Table accessories

Complementos de mesa
Accessoires de table



P638003 Table caddy. 3 Compartments
Caddy de mesa. 3 Compartimentos
Caddy de table. 3 compartiments

Galvanised steel
Acero galvanizado
Acier galvanisé

Wooden handle
Asa de madera
Manche en bois



dishwasher



| REF | W x D x H cm | €/u | 📦 |
|---------|--------------|-------|---|
| P638003 | 26 x 10 x 12 | 16,90 | 6 |

P638004 Table caddy. 4 Compartments
Caddy de mesa. 4 Compartimentos
Caddy de table. 4 compartiments

Galvanised steel
Acero galvanizado
Acier galvanisé

Wooden handle
Asa de madera
Manche en bois



dishwasher



| REF | W x D x H cm | €/u | 📦 |
|---------|--------------|-------|---|
| P638004 | 26 x 18 x 12 | 22,30 | 6 |

Table accessories 15.3

Complementos de mesa
Accessoires de table

P96700 Pepper mill-salt mill. Wooden
Molinillos pimienta y sal. Madera
Moulin à poivre et sel. Bois



| REF | H cm | €/u | 📦 |
|---------|------|-------|---|
| P967007 | 12,5 | 13,05 | 1 |
| P967008 | 15,0 | 15,00 | 1 |
| P967009 | 19,5 | 17,60 | 1 |

P967 Pepper mill-salt mill. Acrylic
Molinillos pimienta y sal. Acrílico
Moulin à poivre et sel. Acrylique



| REF | Type / Tipo | H cm | €/u | 📦 |
|---------|-------------|------|-------|----|
| P967001 | A | 15,5 | 14,90 | 48 |
| P967002 | A | 20,0 | 16,10 | 48 |
| P967003 | A | 23,0 | 17,15 | 48 |
| P967004 | B | 15,5 | 11,15 | 48 |
| P967005 | B | 20,0 | 12,45 | 48 |
| P967006 | B | 23,0 | 13,60 | 48 |

P630 Number card holder
Soporte para número "banquete"
Support numéro "banquet"



| REF | H cm | €/u | 📦 |
|---------|------|-------|----|
| P630010 | 10 | 11,15 | 50 |
| P630020 | 20 | 12,45 | 50 |
| P630030 | 30 | 14,10 | 50 |
| P630040 | 40 | 17,30 | 50 |

P632 Table number
Número de mesa
Numéro de table

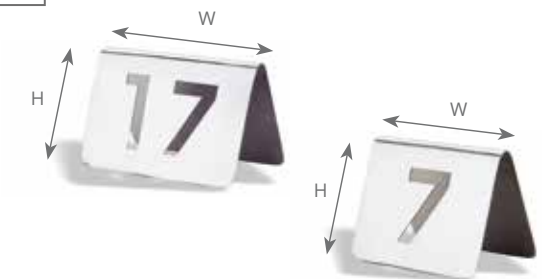

N. 1 - N. 30 ** number with 2 digits.
** número de 2 dígitos.
** numero de 2 chiffres.
* number with 1 digit.
* número de 1 dígito.
* numero d'un seul chiffre.

| REF | W x H cm | €/u | 📦 |
|---------------|-----------|------|---|
| P63200 + NUM* | 6,4 x 5,6 | 3,00 | 1 |
| P6320 + NUM** | 7,6 x 5,6 | 3,00 | 1 |

P633 "Reserved" table sign
Placa "Reservado"
Plaque "reserve"



| REF | Text | W x H cm | €/u | 📦 |
|---------|-----------|----------|------|-----|
| P633000 | RESERVADO | 10 x 5 | 4,60 | 300 |
| P633002 | RESERVED | 10 x 5 | 4,60 | 200 |
| P633003 | RESERVE | 10 x 5 | 4,60 | 310 |

P634 "Non-smoking" sign
Placa "Prohibido fumar"
Plaque "Défense de fumer"



| REF | W x H cm | €/u | 📦 |
|---------|-----------|------|-----|
| P634000 | 7,6 x 5,6 | 3,95 | 100 |

15.3 Table accessories

Complementos de mesa
Accessoires de table

P969 Stand for tray Soporte elevador Support pour plateau



| REF | Ø cm | H cm | €/u | |
|---------|---------|------|-------|----|
| P969000 | 25 / 20 | 19,0 | 29,60 | 12 |

P968 Carry-skewers Porta pinchos Porte-brochettes



| REF | Ø cm | H cm | €/u | |
|---------|------|------|-------|---|
| P968000 | 22 | 46 | 37,05 | 1 |

P8621 Non slip oval serving tray Bandeja oval antideslizante Plateau antidérapant forme ovale



Black color
Color negro
Couleur noir

| REF | cm | €/u | |
|---------|---------|-------|---|
| P862100 | 68 x 56 | 42,35 | 6 |

P9681 Skewer Pincho Brochette



Price 12 units box.
Precio caja 12 unidades.
Prix colis 12 unités.

| REF | L cm | €/u | |
|---------|------|------|---|
| P968125 | 25 | 7,10 | 1 |
| P968130 | 30 | 8,05 | 1 |
| P968135 | 35 | 9,05 | 1 |

P874 Bill spike Pinchanotas Epingle porte-tickets



| REF | Ø cm | H cm | €/u | |
|---------|------|------|------|----|
| P874000 | 9 | 22 | 5,15 | 50 |

P863 Large tray holder Soporte para bandejas de gran tamaño Support pour grands plateaux



Serving tray not included.
No incluye bandeja.
Plateau non inclus.

| REF | W x D x H cm | €/u | |
|---------|----------------|--------|---|
| P863000 | 47 x 47 x 76,5 | 124,35 | 6 |

Table accessories 15.3

Complementos de mesa
Accessoires de table



P650 St/Steel table-tidy Papelera sobremesa acero inox Receptacle à déchets de table



| REF | Ø cm | H cm | €/u | |
|---------|------|------|-------|----|
| P650000 | 12 | 21 | 17,50 | 36 |

P638 Water ashtray Cenicero de agua Cendrier à eau



| REF | Ø cm | H cm | €/u | |
|---------|------|------|------|-----|
| P638000 | 11 | 5,5 | 9,15 | 100 |

P625 Table crumber Pala recogemigas Pelle ramasse-miettes

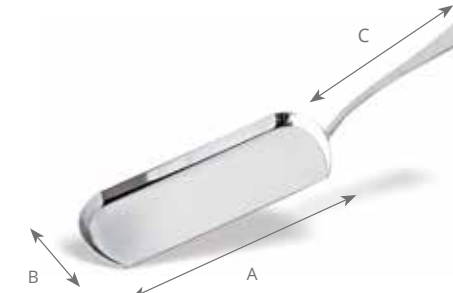

| REF | A x B x C cm | €/u | |
|---------|---------------|------|-----|
| P625000 | 18 x 7 x 12,5 | 8,75 | 144 |

P357 Napkin holder Servilletero Porte-serviettes



| REF | H x W x D cm | €/u | |
|---------|---------------|-------|----|
| P357000 | 13 x 9,8 x 10 | 12,80 | 72 |

P639 Deep ashtray Cenicero hondo Cendrier profond



| REF | H x W x D cm | €/u | |
|---------|-------------------|------|-----|
| P639000 | 2,5 x 12,5 x 12,5 | 4,25 | 200 |

See products on
Ver productos en / Voir produits en page

P. 383

Melamine
Melamina
Mélamine



15.3 Menu holders

Portamenús
Porte-menus

- Made of PVC.
- Pockets on each back cover.
- For DIN A4 and DIN A5 sheets.

- Fabricado en PVC.
- Bolsillos en contratapa interior.
- Para hojas DIN A4 y DIN A5.

- Fabriqué en PVC.
- Poches avec couverture intérieure.
- Pour feuilles DIN A4 et DIN A5.

P2004 Elegance menu holder

Portamenús Elegance
Porte-Menus Elegance

PVC



Up to 10 pages: cover back + 4 double inner pages + back cover front.

Para 10 páginas: 4 fundas dobles + 2 laterales.

Pour 10 pages: 4 feuilles plastiques doubles + 2 latérales.

| REF | cm | Colour / Color | €/u | 📦 |
|--------|---------|-------------------------------|-------|---|
| P20041 | 33 x 24 | Burdeos / Burgundy / Bordeaux | 14,40 | 1 |
| P20042 | 33 x 24 | Negro / Black / Noir | 14,40 | 1 |

P636 Menu holder

Portamenús
Porte-menu de table

SS
Stainless steel



| REF | H cm | €/u | 📦 |
|---------|------|------|-----|
| P636000 | 2 | 5,40 | 200 |

P20066 Bill Holder

Porta facturas
Porte-addition



| REF | W x H cm | Colour / Color | €/u | 📦 |
|--------|-----------|----------------------|-------|---|
| P20066 | 24,5 x 17 | Negro / Black / Noir | 25,80 | 1 |
| P20069 | 20 x 13,5 | Negro / Black / Noir | 23,70 | 1 |

P20050 Elegance Bill holder

Porta blocs Elegance
Porte-addition Elegance

PVC



| REF | cm | Colour / Color | €/u | 📦 |
|--------|---------|----------------------|------|----|
| P20050 | 23 x 13 | Negro / Black / Noir | 8,85 | 72 |

P637 Bill holder

Platillo cambio
Porte-addition

SS
Stainless steel



| REF | cm | €/u | 📦 |
|---------|-------------|------|-----|
| P637000 | 15,5 x 11 | 4,55 | 200 |
| P637100 | 21,5 x 12,5 | 5,40 | 120 |

P635 Card holder

Portatarjetas
Porte-cartes

SS
Stainless steel

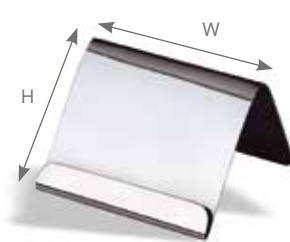

| REF | W x H cm | €/u | 📦 |
|---------|-----------|------|-----|
| P635000 | 6,2 x 5,2 | 3,95 | 500 |

Food & table service 15.4

Servicio de mesa
Arts de table

Plate Covers

Tapas para platos
Couvercles à assiette

Plate covers keep food at its ideal serving temperature for improved customer satisfaction. Hemmed finger hole.

Las tapas para platos mantienen la comida a la temperatura ideal para servir. Se ofrecen con orificio central.

Les couvre-assiettes maintiennent les aliments à la température idéale de service pour améliorer la satisfaction du client. Trou ourlé pour passer le doigt.



62300 Stainless Steel Plate Covers

Tapas Acero inoxidable para platos
Inox couvercles à assiette

SS
Stainless steel

Stackable
Apilable
Empilable



Satin-finish keeps covers looking better longer
El acabado satinado mantiene más tiempo el buen aspecto de las tapas
Fini satin pour un attrait durable

| REF | For / Para / Pour Ø cm | H cm | €/u | 📦 |
|-------|---------------------------|------|-------|--------|
| 62300 | 22,9 - 23,2 | 5,9 | 25,00 | 12 |
| 62301 | 23,3 - 23,5 | 5,9 | 25,00 | 12 NEW |
| 62303 | 24,0 - 24,1 | 5,9 | 25,00 | 12 |
| 62305 | 24,6 - 24,8 | 5,9 | 25,00 | 12 NEW |
| 62309 | 25,9 - 26,0 | 5,9 | 27,20 | 12 NEW |
| 62311 | 26,5 - 26,7 | 5,9 | 27,20 | 12 NEW |
| 62312 | 26,8 - 27,0 | 5,9 | 27,20 | 12 |
| 62313 | 27,1 - 27,3 | 5,9 | 27,20 | 12 |
| 62314 | 27,5 - 27,6 | 5,9 | 27,20 | 12 NEW |
| 62315 | 27,8 - 27,9 | 5,9 | 27,20 | 12 |
| 62318 | 28,1 - 28,3 | 5,9 | 30,95 | 12 |
| 62321 | 29,1 - 29,2 | 5,9 | 30,95 | 12 |
| 62322 | 29,4 - 29,5 | 7,1 | 31,55 | 12 NEW |
| 62323 | 29,7 - 29,8 | 7,1 | 31,55 | 12 NEW |
| 62325 | 30,3 - 30,5 | 7,1 | 36,80 | 12 NEW |
| 62326 | 30,6 - 30,8 | 5,9 | 35,60 | 12 |
| 62327 | 31,0 - 31,1 | 7,1 | 36,80 | 12 NEW |
| 62328 | 31,3 - 31,4 | 7,1 | 36,80 | 12 NEW |

918 Plastic Plate Covers

Tapas plástico para platos
Plastique couvercles à assiette

PC
Polycarbonate

+ 93°C

Stackable
Apilable
Empilable

Clear
Transparente
Transparent

Dishwasher
Lavavajillas
Lave-vaisselle



| REF | For / Para / Pour Ø cm | H cm | €/u | 📦 |
|---------|---------------------------|------|-------|--------|
| 918-13 | 21,6 - 23,2 | 6,7 | 13,05 | 12 |
| 1078-13 | 26,7 - 27,0 | 7,0 | 16,10 | 12 |
| 1100-13 | 28 | 7,2 | 17,50 | 12 NEW |
| 1200-13 | 30,50 | 7,2 | 18,50 | 12 NEW |

Ask about other available sizes
Consultar otras medidas disponibles
Consulter autres dimensions disponibles

16 Bar & coffee

Bar y cafetería
Bar et cafétéria



16.1 BEVERAGE TROLLEY 488

CARRO BEBIDAS / CHARIOT BOISSONS

Cocktail trolley / Carro cocktail / Chariot cocktail 488
Liquor trolley / Carro licor / Chariot à liqueurs 490

16.2 BAR 491

Wine Buckets / Cubiteras / Seaux à champagne 491
Cocktail Service / Coctelería / Cocktail 496
Bar Mats / Alfombras para bar / Tapis de bar 498
Condiment Dispensers / Dispensador de condimentos
Distributeur de condiments 499
Wine Complements / Complementos de vino / Accessoires de vin 500
Trays / Bandejas / Plateaux 501

16.3 TEA & COFFEE SERVICE 502

TÉ Y CAFETERÍA / THÉ ET CAFÉTÉRIA

Planet 502
Cosmos 504
Atlantis 504
Tea Pots / Teteras / Théières 505

16.4 BEVERAGE SERVICE 506

SERVICIO DE BEBIDAS / SERVICE À BOISSONS

Servers / Servidores / Verseuses 506
Pitchers / Jarras / Pichets 508

16.5 LIDSAVERS AND CUPDISPENSERS 510

DISPENSADORES DE TAPAS Y VASOS
DISTRIBUTEUR DE COUVERCLES ET GOBELETS

16.1 Cocktail trolley

Carro cocktail / Chariot cocktail

Trolley with an innovative and versatile design, with multiple storage spaces and a large work area.

Carro de diseño innovador y versátil, con múltiples espacios de almacenaje y una amplia zona de trabajo.

Chariot au design innovant et polyvalent, avec de multiples espaces de rangement et un grand espace de travail.

Carbon steel structure with anti-rust coating and satin black paint.

Estructura de acero al carbono con recubrimiento antioxidante y pintura negra satinada.

Structure en acier au carbone avec revêtement antioxydant et peinture noire satinée.

NEW!



It can be customized with a logo.
Se puede personalizar con logo.
Personnalisable avec logo.

2 speed rails

Elements of the work area in stainless steel.

Elementos del área de trabajo en acero inoxidable.

Éléments de la zone de travail en acier inoxydable.

Solid anti-humidity board with oak finish.

Tablero macizo antihumedad acabado roble.

Panneau massif anti-humidité finition chêne.

Drawer with metal runners

Cajón con guías metálicas

Tiroir avec guides métalliques



Revolving casters, two with brakes

Ruedas giratorias, dos con frenos

Roues giratoires, deux avec freins

5 rails for hanging glasses

5 railes para colgar copas

5 rails pour suspendre les verres



Cocktail trolley 16.1

Carro cocktail

Chariot cocktail

Elements included:

Elementos incluidos:

Éléments inclus :

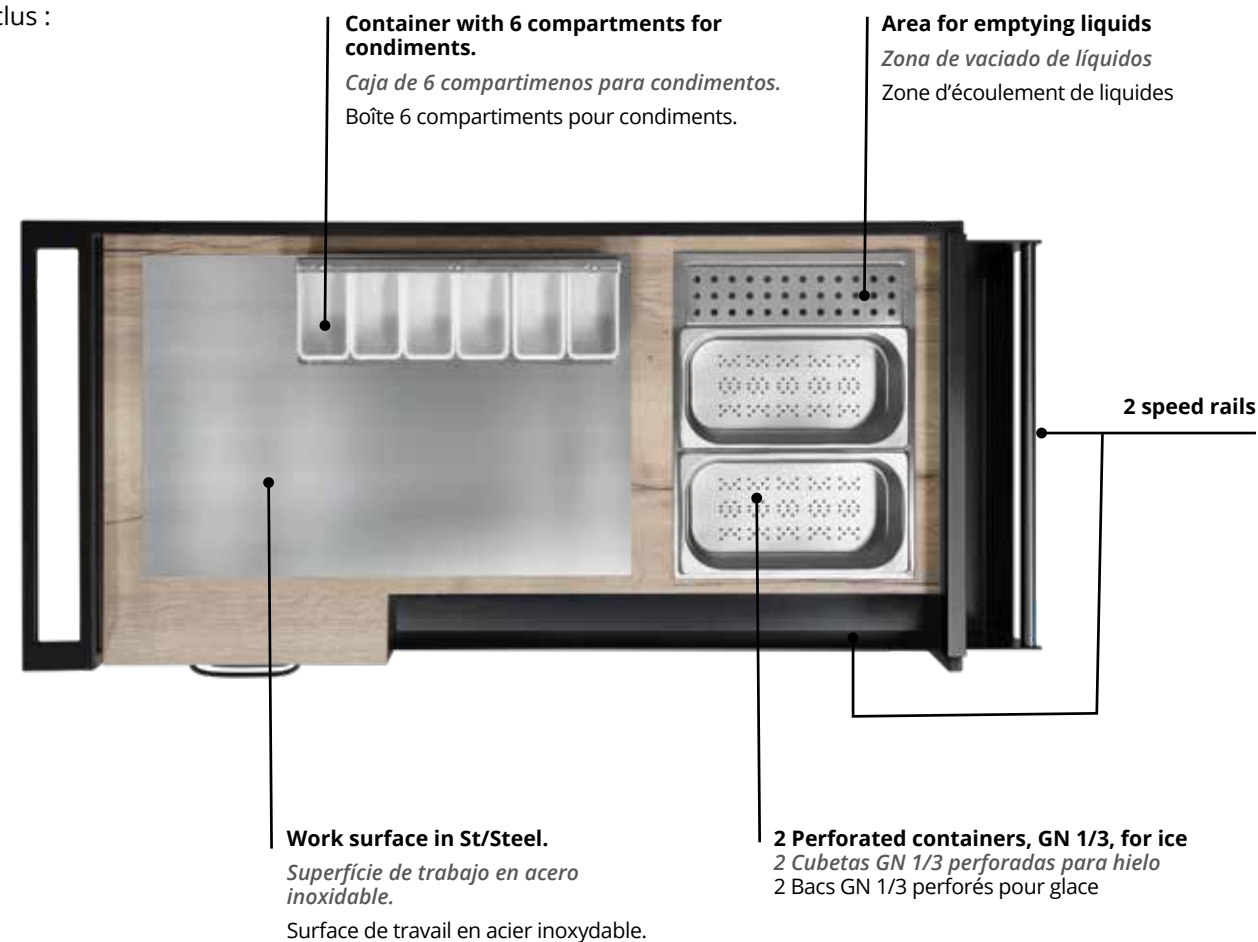

Container with 6 compartments for condiments.

Caja de 6 compartimentos para condimentos.
Boîte 6 compartiments pour condiments.

Area for emptying liquids

Zona de vaciado de líquidos
Zone d'écoulement de liquides

2 speed rails

Work surface in St/Steel.

Superficie de trabajo en acero inoxidable.

Surface de travail en acier inoxydable.

2 Perforated containers, GN 1/3, for ice

2 Cubetas GN 1/3 perforadas para hielo

2 Bacs GN 1/3 perforés pour glace

P90910 Cocktail trolley with stainless steel work module

Carro cocktail con área de trabajo

Chariot à cocktails avec zone de travail



P90911 Hanging bottle rack

Botellero colgante

Porte-bouteilles suspendu



Maximum 3 per trolley

Máximo 3 por carro.

Maximum 3 par chariot.

| REF | W x D x H cm | €/u | 📦 |
|--------|-------------------|----------|---|
| P90910 | 132,5 x 63 x 98,5 | 3.495,00 | 1 |

| REF | W x D x H cm | €/u | 📦 |
|--------|------------------|--------|---|
| P90911 | 59,5 x 12 x 23,5 | 139,00 | 1 |

16.1 Liquor trolley

Carro licor
Chariot à liqueurs



NEW!

Carbon steel structure with anti-rust coating and satin black paint.

Estructura de acero al carbono con recubrimiento antioxidante y pintura negra satinada.

Structure en acier au carbone avec revêtement antioxydant et peinture noire satinée.

| REF | W x D x H cm | € / u | |
|--------|----------------|----------|---|
| P90930 | 91,5 x 63 x 98 | 2.195,00 | 1 |

3 speed rails

Solid anti-humidity board with oak finish.

Tablero macizo antihumedad acabado roble.

Panneau massif anti-humidité finition chêne.

3 rails for hanging glasses

3 railes para colgar copas
3 rails pour suspendre les verres

Area for rocks glasses.
20-glass capacity.

Zona para vasos de licor.
Capacidad para 20 vasos.
Zone pour verres à liqueur.
Capacité pour 20 verres.

Shelves for mixers

Estanterías para mixers
Étagères pour mixers



Wine Buckets 16.2

Cubiteras
Seaux à champagne



P972 Champagne bucket
Cubo champán
Seau à champagne

SS
Stainless
steel



dishwasher

NEW!



Sophistication and durability

Sofisticación y durabilidad
Sophistication et durabilité

Elevate the presentation of your drinks. Add a touch of sophistication with these ice buckets made from stainless steel, painted in stylish colours on the outside.

Eleva la presentación de tus bebidas. Añade un toque de sofisticación con estas cubiteras realizadas en acero inoxidable y pintadas en elegantes colores por la parte exterior.

Sublimez la présentation de vos boissons. Apportez une note de sophistication aux seaux à glace en acier inoxydable avec revêtements extérieurs élégants.

| REF | Ø cm | H cm | Colour / Color | € / u | |
|---------|------|------|-------------------------|-------|---|
| P972201 | 21 | 20 | Gold / oro / or | 19,25 | 1 |
| P972202 | 21 | 20 | Black / negro / noir | 19,25 | 1 |
| P972203 | 21 | 20 | Copper / cobre / cuivre | 19,25 | 1 |

P976 Hammered champagne bucket with handles
Cubo champán hammered con asas
Seau à champagne martelé avec poignées

SS
Stainless
steel

NEW!



47620 Champagne bucket with fixed handles
Cubo champán con asas fijas
Seau à champagne à poignées fixes

SS
Stainless
steel

NEW!



| REF | Ø cm | H cm | € / u | |
|---------|------|------|-------|---|
| P976210 | 21 | 20 | 19,60 | 1 |

| REF | Ø cm | H cm | € / u | |
|-------|------|------|-------|---|
| 47620 | 21 | 19,7 | 77,50 | 1 |

16.2 Wine Buckets

Cubiteras
Seaux à champagne



P311F71 Conical champagne bucket with rings
Cubo champán cónico con anillas
Seau à champagne conique à anneaux



| REF | Ø cm | H cm | €/u | |
|---------|------|------|-------|---|
| P311071 | 20 | 19,5 | 37,25 | 1 |

P311F2 Champagne bucket with fixed handles
Cubo champán con asas fijas
Seau à champagne à poignées fixes



| REF | Ø cm | H cm | €/u | |
|---------|------|------|-------|---|
| P311002 | 18 | 19 | 33,00 | 1 |

P311F6 Champagne bucket with rings
Cubo champán con anillas
Seau à champagne à anneaux



| REF | Ø cm | H cm | €/u | |
|---------|------|------|-------|---|
| P311006 | 18 | 19 | 33,00 | 1 |

P326 Champagne bucket two bottles
Cubo champán dos botellas
Seau à champagne deux bouteilles



| REF | Ø cm | H cm | €/u | |
|---------|------|------|-------|---|
| P326000 | 25 | 22 | 42,30 | 1 |

P9762 Conical champagne bucket with handles
Cubo champán cónico con asas
Seau à champagne conique avec poignées



| REF | Ø cm | H cm | €/u | |
|---------|------|------|-------|----|
| P976200 | 21 | 20 | 17,45 | 24 |

P9763 Conical champagne bucket with rings
Cubo champán cónico con anillas
Seau à champagne conique à anneaux



| REF | Ø cm | H cm | €/u | |
|---------|------|------|-------|----|
| P976300 | 19 | 19 | 16,75 | 24 |

Wine Buckets 16.2

Cubiteras
Seaux à champagne



P312 Ice bucket with separative disk
Cubo para hielo con disco separador
Seau à glaçons avec disque de séparation



| REF | Ø cm | H cm | €/u | |
|---------|------|------|-------|----|
| P312000 | 11 | 13 | 23,50 | 50 |

P310 Ice cube bowl
Cubitera tipo ensaladera
Vasque



| REF | Ø cm | H cm | Lts | €/u | |
|---------|------|------|-----|-------|---|
| P310000 | 40 | 24,5 | 13 | 98,05 | 1 |

P3110 St/Steel bucket-holder stand
Pie portacubos acero inox
Pied porte-seau



* Suitable for references
Compatible con los modelos
Compatible avec les références
P311.F2, P311.F6, P311.F71

** For 2 bottles bucket
Para cubitera 2 botellas
Pour seau à champagne
2 bouteilles

| REF | Ø cm | H cm | €/u | |
|-----------|------|------|-------|---|
| P311004* | 18 | 67,5 | 70,40 | 1 |
| P311020** | 22 | 69,0 | 76,40 | 1 |

P974 Double wall insulated cooler
Enfriador isotérmico doble pared
Rafraîchisseur isotherme double paroi



| REF | Ø cm | H cm | €/u | |
|---------|------|------|-------|----|
| P974000 | 10,5 | 20 | 21,30 | 24 |

P327 Ice cube bowl
Cubitera tipo ensaladera
Vasque



| REF | Ø cm | H cm | Lts | €/u | |
|---------|------|------|-----|-------|---|
| P327000 | 35 | 25 | 10 | 82,50 | 1 |

47611 St/Steel bucket-holder stand
Pie portacubos acero inox
Pied porte-seau



NEW!

| REF | Ø cm | H cm | €/u | |
|-------|------|------|--------|---|
| 47611 | 19,5 | 60 | 236,10 | 1 |

16.2 Wine Buckets

Cubiteras
Seaux à champagne



dishwasher

P988400 Plastic champagne bucket
Cubitera de plástico
Seau à champagne



| REF | Ø cm | H cm | €/u | |
|---------|------|------|------|---|
| P988400 | 21 | 21,5 | 9,75 | 6 |

P988500 Bi-color plastic champagne bucket
Cubitera bicolor plástico
Seau à champagne bicolore



| REF | Ø cm | H cm | €/u | |
|---------|------|------|-------|---|
| P988500 | 19 | 21 | 16,20 | 1 |

P988600 Oval plastic champagne bucket
Cubitera ovalada plástico
Seau à champagne ovale



| REF | W x D x H cm | €/u | |
|---------|------------------|-------|---|
| P988600 | 32,5 x 23,5 x 22 | 21,35 | 1 |

P988700 Plastic champagne bucket
Cubitera de plástico
Seau à champagne



| REF | Ø cm | H cm | €/u | |
|---------|------|------|-------|---|
| P988700 | 19,5 | 21 | 11,00 | 1 |

VOLLRATH

494

pujadas

Wine Buckets 16.2

Cubiteras
Seaux à champagne

P988900 Oval plastic champagne bucket
Cubitera ovalada plástico
Seau à champagne ovale



| REF | W x D x H cm | €/u | |
|---------|------------------|-------|---|
| P988900 | 44,5 x 41,5 x 25 | 37,20 | 1 |

P9881 Conical acrylic champagne bucket
Cubitera cónica acrílica
Seau à champagne conique



| REF | Ø cm | H cm | €/u | |
|---------|------|------|-------|----|
| P988100 | 20 | 18,5 | 11,40 | 12 |

P9882 Oval acrylic champagne bucket
Cubitera ovalada acrílica
Seau à champagne ovale



*3 BOTTLES
*3 BOTELLAS
*3 BOUTEILLES

| REF | W x D x H cm | €/u | |
|----------|--------------|-------|----|
| P988200 | 27 x 20 x 20 | 24,50 | 12 |
| P988300* | 35 x 26 x 27 | 41,80 | 6 |

P646 Champagne bucket holder
Soporte de mesa para cubo champán
Support de table pour seau à champagne



VOLLRATH

495

P990 Wine cooler
Manta enfriadora
Rafrichisseur

Reversible:
burgundy and silver
Reversible:
burdeos y plata
Réversible:
bordeaux et argenté



| REF | cm | €/u | |
|---------|---------|------|----|
| P990000 | 35 x 18 | 8,50 | 55 |

Suitable with all champagne bucket but:
Compatible con todos los modelos de cubos champán excepto con:
Compatible avec tous les modèles sauf :
ref. P326

| REF | Ø cm | cm | €/u | |
|---------|------|---------|-------|---|
| P646000 | 18 | 52 x 17 | 36,60 | 4 |

pujadas

16.2 Cocktail Service

Cocteleria
Cocktail



P330 Shaker

Coctelera
Shaker



| REF | H cm | Lts | € / u | |
|---------|------|------|-------|----|
| P330035 | 18,0 | 0,35 | 16,45 | 72 |
| P330050 | 20,5 | 0,50 | 19,95 | 72 |
| P330070 | 23,5 | 0,70 | 26,95 | 48 |

46793 Bar shaker

Coctelera
Shaker



Mirror-finished stainless steel. Reinforced bases
Acero inoxidable brillante. Bases reforzadas
Acier inoxydable ultra-brillant. Bases renforcées

| REF | Ø cm | H cm | ml | € / u | |
|-------|------|------|-----|-------|----|
| 46793 | 9,2 | 17,8 | 900 | 21,40 | 12 |
| 46791 | 8,64 | 11,4 | 455 | 19,60 | 12 |

48070 Malt cup

Vaso para malteado
Verre à milkshake



NEW!

Reinforced base. Ideal for malts, milkshakes, ice cream and more.
Bases reforzadas. Ideal para malts, batidos, helados y más.
Bases renforcées. Idéal pour les malts, les milkshakes, la crème glacée et plus encore.

| REF | Ø cm | H cm | ml | € / u | |
|-------|------|------|-----|-------|----|
| 48070 | 10,2 | 17,1 | 900 | 23,60 | 12 |

See products on P. 457
Ver productos en / Voir produits en page



Cocktail Service 16.2

Cocteleria
Cocktail



P388 Ice tong

Pinza hielo
Pince à glace



| REF | L cm | € / u | |
|---------|------|-------|-----|
| P388018 | 18,5 | 4,05 | 100 |

46790 Bar scoop

Cuchara de bar
Pelle à bar



NEW!

Sturdy handle provides a comfortable, reliable grip.
El mango resistente proporciona un agarre cómodo y fiable.
La poignée robuste offre une prise en main confortable et fiable.

| REF | € / u | |
|-------|-------|----|
| 46790 | 8,30 | 24 |

46787 Cocktail strainer

Colador para cócteles
Passoire à cocktail

NEW!



Four prongs provide stability. Removable spring ensures easy and efficient cleaning.

Las cuatro puntas ofrecen estabilidad. El resorte extraíble garantiza una limpieza fácil y eficiente.
Quatre broches assurent la stabilité. Le ressort amovible assure un nettoyage facile et efficace.

| REF | W x D cm | € / u | |
|-------|-------------|-------|----|
| 46787 | 11,5 x 15,7 | 7,90 | 12 |

P319 Cocktail spoon

Cuchara batidora
Cuillère à cocktail



| REF | L cm | € / u | |
|---------|------|-------|-----|
| P319000 | 26,5 | 5,10 | 300 |
| P319100 | 28,0 | 3,65 | 360 |

47104 Ice tong

Pinza hielo
Pince à glace



| REF | L cm | € / u | |
|-------|------|-------|----|
| 47104 | 15,9 | 8,60 | 12 |

P3181 Cocktail strainer

Colador gusanillo
Passoire à cocktail

Four prongs provide stability. Removable spring ensures easy and efficient cleaning

Las cuatro puntas ofrecen estabilidad. El resorte extraíble garantiza una limpieza fácil y eficiente.

Quatre broches assurent la stabilité. Le ressort amovible assure un nettoyage facile et efficace.



| REF | Ø cm | W x D cm | € / u | |
|---------|------|-----------|-------|-----|
| P318100 | 7,6 | 11,7 x 15 | 7,65 | 144 |

P616 Lemon squeezer

Exprime limones
Presse citron



| REF | Ø cm | € / u | |
|---------|------|-------|-----|
| P616000 | 17 | 7,80 | 144 |

P399 Jigger

Dosificador licor
Mesure à cocktail



| REF | Ø cm | H cm | ml | € / u | |
|---------|----------------|----------------|----------|-------|-----|
| P399000 | A 3,7 B 4,1 | A 2,8 B 5,7 | 25 50 | 12,80 | 200 |

16.2 Bar mats

Alfombras para bar
Tapis de bar

P26100 Bar mat
Alfombra de bar para escurrido de copas
Tapis égouttoir pour verres



They can be connected with each other forming bigger surfaces
Se pueden conectar unas con otras formando mayores superficies
Avec système de liaison pour composer une surface plus grande

| REF | W x D x H cm | € / u | |
|--------|----------------|-------|---|
| P26100 | 30 x 30 x 1,20 | 9,40 | 1 |

2331 Service mat
Alfombra bar rectangular
Tapis de service



Flexible thermoplastic rubber
Caucho termoplástico flexible
Caoutchouc thermoplastique flexible

| REF | W x D x H cm | € / u | |
|---------|-------------------|-------|---|
| 2331-99 | 45,7 x 30,5 x 1,3 | 49,15 | 6 |

3616 Bar keep
Botella bar
Bouteille de bar



Includes:
1 neck + 1 jar + 1 lid + 6 assorted colored spouts.

El juego incluye:
1 cuello + 1 jarra + 1 tapa + 6 picos estándar de diversos colores.

Le kit comprend:
1 goulot + 1 récipient + 1 couvercle
+ assortiment de 6 becs verseurs standard en couleurs.

| REF | Lts | cm | € / u | |
|------|------|--------------|-------|----|
| 3616 | 0,47 | 25,7 x 9,20 | 9,10 | 12 |
| 3632 | 0,95 | 34,0 x 9,50 | 10,00 | 12 |
| 3648 | 1,40 | 38,1 x 16,5 | 11,30 | 6 |
| 3664 | 1,90 | 34,90 x 12,7 | 11,95 | 6 |
| 3628 | 3,80 | 43,2 x 14,0 | 18,10 | 6 |

Condiment dispensers 16.2

Dispensador de condimentos
Distributeur de condiments

4741-06 Condiment Bar Dispenser. Black
Caja condimentos negra
Boîte à condiments



4741-06



4743-06

| REF | W x D x H cm | Lts | Compart. | € / u | |
|---------|--------------------|-----|----------|-------|---|
| 4741-06 | 30,5 x 15,2 x 11,4 | 1,9 | 4 | 72,85 | 1 |
| 4743-06 | 45,7 x 15,2 x 15,6 | 2,8 | 6 | 87,35 | 1 |

- Not dishwasher safe.
- Transparent polycarbonate lid with automatic closure.
- The lid design increases the capacity and allows the item to be filled.
- Lids with holes allow utensils to be stored inside with the lid closed.
- Chiller plates are located on the bottom, keeping the condiments cool.

- No aptos para lavavajillas.
- Tapa policarbonato transparente con cierre automático.
- El diseño de la tapa aumenta la capacidad y permite llenar el artículo.
- Las tapas con orificios permiten mantener el utensilio dentro con la tapa cerrada.
- Las placas enfriadoras se colocan en la parte inferior, manteniendo los condimentos fríos.

- Pas adapté pour lave-vaisselle.
- Couvercle en polycarbonate transparent avec fermeture automatique.
- La conception du couvercle augmente la capacité et permet de remplir l'article.
- Les couvercles avec orifices permettent de garder l'ustensile à l'intérieur avec le couvercle fermé.
- Les plaques de refroidissement sont placées sur la partie inférieure, en conservant les condiments froids.

4747 Cooling plate for condiment holder
Placa enfriadora para caja condimentos
Plaque réfrigérante pour Boîte à condiments



| REF | W x D x H cm | € / u | |
|------|-------------------|-------|---|
| 4747 | 13,2 x 11,4 x 2,9 | 7,70 | 6 |

P3994 Condiment holder
Caja condimentos
Condiments



| REF | W x D x H cm | L / Compart. | € / u | |
|---------|---------------|--------------|-------|----|
| P399400 | 30 x 14 x 8,5 | 0,45 x 4 | 29,05 | 12 |
| P399500 | 38 x 14 x 8,5 | 0,45 x 5 | 32,80 | 12 |
| P399600 | 45 x 14 x 8,5 | 0,45 x 6 | 35,40 | 12 |

16.2 Wine complements

Complementos de vino
Accessoires de vin

P985 Bottle stopper
Tapón botella
Bouchon bouteille



| REF | Ø cm | H cm | €/ u | 📦 |
|---------|------|------|------|-----|
| P985000 | 3 | 5,5 | 3,50 | 200 |

46622 Bottle coaster
Base para botellas
Sous-bouteille



NEW!

| REF | Ø cm | €/ u | 📦 |
|-------|------|-------|----|
| 46622 | 15,6 | 13,85 | 24 |

46789 Waiter's corkscrew
Sacacorchos camarero
Tire-bouchon limonadier



NEW!

| REF | L cm | €/ u | 📦 |
|-------|------|------|----|
| 46789 | 11,7 | 8,95 | 12 |

P9845 Wall-mounted corkscrew
Sacacorchos de pared
Tire-bouchon mural



VOLLRATH

500

P983 Ring stop drop
Anillo anti-goteo
Stop gouttes



| REF | Ø cm | H cm | €/ u | 📦 |
|---------|------|------|------|---|
| P983000 | 4 | 2 | 2,45 | 1 |

P984 Double-lever corkscrew
Sacacorchos doble palanca
Tire-bouchon double levier



| REF | cm | €/ u | 📦 |
|---------|--------|------|-----|
| P984100 | 17 x 6 | 7,80 | 144 |

47602 Pulltap's™ Kellnermesser corkscrew
Sacacorchos camarero Pulltap's™
Tire-bouchon de serveur Pulltap's™



PATENTED

Double lever
Palanca doble
Double levier

Five turn Teflon® coated forged steel. Internal cutting blade.
Acero forjado revestido de Teflon®. Hoja de corte interior.
Acier forgé revêtu de Teflon® cinq tours. Lame coupante intérieure.

| REF | Spirale / Espiral cm | L cm | €/ u | 📦 |
|-------|----------------------|------|-------|----|
| 47602 | 5,1 | 11,7 | 19,90 | 10 |

| REF | W x D x H cm | €/ u | 📦 |
|---------|--------------|-------|---|
| P984500 | 8 x 26 x 32 | 88,20 | 6 |

pujadas

Trays 16.2

Bandejas
Plateaux

P619 St/Steel round serving tray
Bandeja camarero en acero inox
Plateau limonadier en acier inox



Mirror finished
Pulido brillante
Polissage brillant



| REF | Ø cm | €/ u | 📦 |
|---------|------|-------|---|
| P619002 | 35 | 19,15 | 1 |
| P619000 | 40 | 23,45 | 1 |

VOLLRATH

501

1474 Non-Skid Trays
Bandeja camarero antideslizante
Plateau de service antidérapant

Non-slip
Antideslizante
Antidérapant

Black
Negro
Noir



| REF | Ø cm | €/ u | 📦 |
|-----------|------|-------|----|
| 1474-0606 | 35,6 | 24,00 | 12 |
| 1476-0606 | 40,6 | 34,15 | 12 |

P956 Non slip serving tray
Bandeja camarero antideslizante
Plateau de service antidérapant



Black and brown colour
Color Negro i marrón
Couleur noir et marron



| REF | Ø cm | €/ u | 📦 |
|---------|------|------|----|
| P956035 | 35 | 7,95 | 12 |
| P956040 | 40 | 9,75 | 12 |
| P956135 | 35 | 7,95 | 12 |
| P956140 | 40 | 9,75 | 12 |

VOLLRATH

501

1612 Anti-Skid Mat Tray Accessories
Mantel antideslizante
Tapis antidérapant



| REF | cm | €/ u | 📦 |
|---------|-----------|-------|----|
| 1612-06 | 41 x 31,8 | 13,60 | 12 |
| 1420-01 | Ø 31,8 | 14,95 | 12 |

VOLLRATH

501

pujadas

NEW



SS
Stainless
steel

P8920B White creamer
Lechera blanca
Crémière blanche



| REF | Lts | € / u | |
|----------|------|-------|---|
| P892015B | 0,15 | 9,00 | 1 |
| P892035B | 0,35 | 13,60 | 1 |
| P892060B | 0,60 | 18,80 | 1 |

P8920N Black creamer
Lechera negra
Crémière noire



| REF | Lts | € / u | |
|----------|------|-------|---|
| P892015N | 0,15 | 9,00 | 1 |
| P892035N | 0,35 | 13,60 | 1 |
| P892060N | 0,60 | 18,80 | 1 |

P8920R Red creamer
Lechera roja
Crémière rouge



| REF | Lts | € / u | |
|----------|------|-------|---|
| P892015R | 0,15 | 9,00 | 1 |
| P892035R | 0,35 | 13,60 | 1 |
| P892060R | 0,60 | 18,80 | 1 |

SS
Stainless
steel

P890 Tea pot with filter
Tetera con filtro
Théière avec filtre



| REF | Lts | € / u | |
|---------|------|-------|----|
| P890025 | 0,25 | 14,30 | 72 |
| P890035 | 0,35 | 18,65 | 36 |
| P890060 | 0,60 | 24,50 | 36 |

P892 Creamer
Lechera
Crémière



| REF | Lts | € / u | |
|---------|------|-------|----|
| P892015 | 0,15 | 7,25 | 72 |
| P892025 | 0,25 | 10,10 | 72 |
| P892035 | 0,35 | 11,75 | 36 |
| P892060 | 0,60 | 16,70 | 36 |
| P892100 | 1,00 | 22,40 | 36 |
| P892150 | 1,50 | 29,80 | 24 |
| P892200 | 2,00 | 36,80 | 24 |

P891 Coffee pot with filter
Cafetera con filtro
Cafetière avec filtre



| REF | Lts | € / u | |
|---------|------|-------|----|
| P891035 | 0,35 | 17,15 | 36 |
| P891060 | 0,60 | 23,45 | 36 |
| P891100 | 1,00 | 30,55 | 36 |

P893 Sugar bowl with lid
Azucarero con tapa
Sucrier avec couvercle



| REF | Lts | € / u | |
|---------|------|-------|----|
| P893025 | 0,25 | 10,60 | 72 |
| P893035 | 0,35 | 11,95 | 72 |

16.3 Cosmos

P885 Tea pot with filter
Tetera con filtro
Théière avec filtre



| REF | Lts | € / u | |
|---------|------|-------|-----|
| P885025 | 0,25 | 23,35 | 108 |
| P885040 | 0,40 | 28,20 | 36 |
| P885060 | 0,60 | 33,55 | 36 |

P886 Coffee pot with filter
Cafetera con filtro
Cafetière avec filtre



| REF | Lts | € / u | |
|---------|------|-------|----|
| P886035 | 0,35 | 27,25 | 36 |

P887 Creamer
Lechera
Crémère

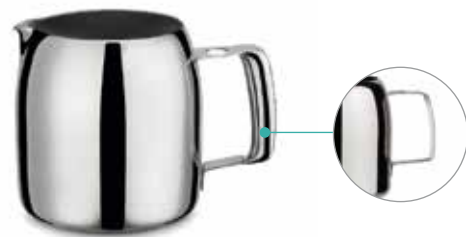

| REF | Lts | € / u | |
|----------|------|-------|----|
| P887015* | 0,15 | 9,40 | 72 |
| P887025* | 0,25 | 15,95 | 72 |
| P887060 | 0,60 | 22,00 | 36 |
| P887100 | 1,00 | 36,75 | 24 |

* Special handle design for refs. P887015 and P887025 for a better handling.
Diseño especial asas refs. P887015 y P887025 para facilitar el manejo.
Spécial design pour anses ref. P887015 et P887025 des améliorer la prise en main.

Atlantis

SS
Stainless
steel

P880 Tea pot with filter
Tetera con filtro
Théière avec filtre



| REF | Lts | € / u | |
|---------|------|-------|----|
| P880035 | 0,35 | 35,70 | 50 |
| P880050 | 0,50 | 42,25 | 50 |

P881 Coffee pot with filter
Cafetera con filtro
Cafetière avec filtre



| REF | Lts | € / u | |
|---------|------|-------|---|
| P881100 | 1,00 | 54,95 | 1 |

P882 Creamer
Lechera
Crémère



| REF | Lts | € / u | |
|---------|------|-------|----|
| P882015 | 0,15 | 11,75 | 50 |
| P882035 | 0,35 | 19,70 | 50 |
| P882100 | 1,00 | 37,30 | 50 |

Tea pots 16.3

Teteras
Théières



P23003 "Japan" tea pot
Tetera "Japón"
Théière "Japon"

CI
Cast
Iron



Cast iron.
Hierro fundido.
Fonte en fer.

Enameled inside.
Esmaltado interior.
Intérieur émaillé.



With St/Steel filter.
Con filtro de acero inoxidable.
Avec filtre en acier inoxydable.

| REF | Filter / Filtro / Filtre Ø cm | Lts | € / u | |
|--------|----------------------------------|------|-------|----|
| P23003 | 7,0 | 0,35 | 32,80 | 12 |
| P23004 | 8,0 | 0,80 | 47,05 | 8 |

P23015 "Kenya" tea pot
Tetera "Kenya"
Théière "Kenya"

CI
Cast
Iron



Cast iron.
Hierro fundido.
Fonte en fer.

Enameled inside.
Esmaltado interior.
Intérieur émaillé.



With St/Steel filter.
Con filtro de acero inoxidable.
Avec filtre en acier inoxydable.

| REF | Filter / Filtro / Filtre Ø cm | Lts | € / u | |
|--------|----------------------------------|------|-------|----|
| P23015 | 7,0 | 0,30 | 35,15 | 12 |

P23008 "Nipon" tea pot
Tetera "Nipon"
Théière "Nipon"

CI
Cast
Iron



Cast iron.
Hierro fundido.
Fonte en fer.

Enameled inside.
Esmaltado interior.
Intérieur émaillé.



With St/Steel filter.
Con filtro de acero inoxidable.
Avec filtre en acier inoxydable.

| REF | Filter / Filtro / Filtre Ø cm | Lts | € / u | |
|--------|----------------------------------|------|-------|----|
| P23008 | 7,0 | 0,30 | 28,30 | 12 |
| P23009 | 8,0 | 0,60 | 37,90 | 8 |

P896 Coffee maker - herbal tea jug
Jarra para infusiones
Pot à infusions

SS
Stainless
steel

Cr
Crystal



+100°C

To remove the glass it is
necessary to unscrew.
Para sacar el cristal es
necesario desatornillar.
Pour enlever le verre il est
nécessaire de dévisser.

| REF | Lts | € / u | |
|---------|------|-------|----|
| P896003 | 0,35 | 15,60 | 30 |
| P896008 | 0,80 | 21,00 | 24 |

16.4 Servers

Servidores
Verseuses



Servers 16.4

Servidores
Verseuses

P894 Airpot thermo inox with feeder
Termo con dosificador
Verseuse à pompe



Rotative base.
Base rotativa.
Fond rotatif.

Inner side in St/Steel
Interior en acero inoxidable
Intérieur en acier inoxydable

| REF | Lts | € / u | |
|---------|------|-------|---|
| P894003 | 3,00 | 60,00 | 6 |
| P894004 | 4,00 | 67,30 | 6 |
| P894005 | 5,00 | 73,45 | 6 |

P896 Airpot thermo inox with feeder
Termo inox con dosificador
Verseuse à pompe thermo inox



Rotative base.
Base rotativa.
Fond rotatif.

Inner side in St/Steel
Interior en acero inoxidable
Intérieur en acier inoxydable

| REF | Lts | € / u | |
|---------|-----|-------|---|
| P896001 | 1,9 | 54,30 | 1 |
| P896002 | 3,0 | 62,60 | 1 |

P337 Luxe insulated coffee pot
Jarra termo luxe
Pichet isolant luxe

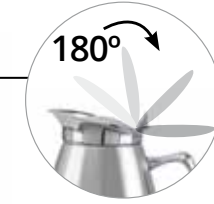

Inner side in St/Steel
Interior en acero inoxidable
Intérieur en acier inoxydable

IDEA! Ideal for dishwasher.
Ideal para lavavajillas.
Ideal pour lave-vaisselle.

| REF | Lts | € / u | |
|---------|------|--------|----|
| P337030 | 0,30 | 51,55 | 12 |
| P337060 | 0,60 | 57,05 | 12 |
| P337090 | 0,90 | 64,55 | 12 |
| P337150 | 1,50 | 81,00 | 12 |
| P337200 | 2,00 | 103,15 | 12 |

P895 Vacuum jug
Servidor termo
Verseuse thermo



Inner side in St/Steel
Interior en acero inoxidable
Intérieur en acier inoxydable



| REF | Lts | € / u | |
|---------|------|-------|---|
| P895006 | 0,60 | 22,05 | 6 |
| P895010 | 1,00 | 25,35 | 6 |
| P895015 | 1,50 | 29,45 | 6 |
| P895020 | 2,00 | 32,05 | 6 |

P898 Thermo jug
Jarra termo
Pichet isotherme



dishwasher



Inner side in glass
Interior en vidrio
Intérieur en veurre

| REF | Colour / Color | Lts | € / u | |
|---------|----------------|-----|-------|---|
| P898001 | | 1 | 18,80 | 1 |
| P898002 | | 1 | 18,80 | 1 |

52172 Hot-N-Cold **SWIRLSERVE®**
Servidor termo Hot-N-Cold
Pichet isotherme Hot-N-Cold



dishwasher microwave

Looks like porcelain
Aspecto cerámico
Ressemble à la
porcelaine



With orange, brown, and white tabs allow easy differentiation.
Con pestañas de color naranja, marrón o blanca que permiten
diferenciar fácilmente.
Avec pousoirs orange, marron ou blanc pour une meilleure
différenciation.

| REF | Colour / Color | Lts | € / u | |
|-------|----------------|------|-------|----|
| 52172 | | 0,60 | 25,90 | 12 |
| 52162 | | 0,60 | 25,90 | 12 |
| 52170 | | 1,25 | 37,75 | 12 |
| 52160 | | 1,25 | 37,75 | 12 |
| 52174 | | 1,90 | 58,10 | 6 |
| 52164 | | 1,90 | 58,10 | 6 |

16.4 Pitchers

Jarras
Pichets



Pitchers

Jarras
Pichets

46599 Server without lid
Jarra bombada con retén
Pichet bombé avec retenu



| REF | Lts | €/u | |
|-------|-----|--------|---|
| 46599 | 1,8 | 127,00 | 1 |

P335 Server without lid
Jarra bombada con retén
Pichet bombé avec retenu



| REF | Lts | €/u | |
|---------|-----|-------|----|
| P335002 | 1,8 | 37,05 | 20 |

Pitchers 16.4

Jarras
Pichets

P6464 Server
Jarra
Pichet



Tube for ice
Tubo para hielo
Tube pour les glaçons



Ideal for juices.
Ideal para zumos.
Idéal pour des jus.

| REF | Lts | €/u | |
|---------|-----|-------|---|
| P646400 | 1,9 | 28,50 | 6 |

P6442 Server
Jarra
Pichet

EXCLUSIVE



Made of SAN.
Fabricada en SAN.
Fabriquée en SAN.

+80°C



| REF | Lts | €/u | |
|---------|------|-------|----|
| P644200 | 1,00 | 8,50 | 12 |
| P644240 | 1,40 | 9,65 | 12 |
| P644275 | 1,75 | 11,10 | 12 |

P6463 Polypropylene lid for stackable Server
Tapa polipropileno para jarra apilable
Couvercle polypropylène pour pichet empilable



| REF | Color / Colour | Lts | €/u | |
|---------|----------------|-----|------|----|
| P646300 | Blue | 1 | 2,95 | 24 |
| P646310 | Grey | 1 | 3,15 | 24 |
| P646301 | Blue | 2 | 3,25 | 12 |

P649 Carafe tritan
Jarra agua tritan
Carafe en tritan



EXCLUSIVE



| REF | Lts | €/u | |
|---------|------|-------|---|
| P649050 | 0,50 | 12,85 | 1 |
| P649100 | 1,00 | 16,50 | 1 |

P646 Stackable polycarbonate server without lid
Jarra policarbonato apilable sin tapa
Pichet polycarbonate empilable sans couvercle



| REF | Color / Colour | Lts | €/u | |
|---------|----------------|-----|-------|----|
| P646100 | Blue | 1 | 9,80 | 24 |
| P646103 | Blue | 1 | 11,80 | 24 |
| P646105 | Green | 1 | 11,80 | 24 |
| P646200 | Green | 2 | 16,35 | 24 |

Fits only on the stackable polycarbonate servers P646.
Sólo para jarra policarbonato apilable sin tapa P646.
Adaptables uniquement sur les pichets polycarbonate empilables P646.

16.5 Lidsavers and cupdispensers

Dispensadores de tapas y vasos
Distributeur de couvercles et gobelets



LIDSAVER™ 3

SANITARY SOLUTIONS

- Sanitary dispensing system helps eliminate contamination from excess handling.
- Keeps operations clean and tidy, addressing major consumer concerns about health and well-being.

SOLUCIONES HIGIÉNICAS

- El sistema de dispensado higiénico previene la contaminación por manipulación excesiva.
- Mantiene las operaciones limpias y ordenadas y responde a las inquietudes de los consumidores en cuanto a salud y bienestar.

SOLUTIONS HYGIÉNIQUES

- Ce système de distribution hygiénique empêche la contamination causée par une manipulation excessive.
- Maintient les locaux propres et ordonnés, répondant ainsi aux principaux soucis des clients en ce qui concerne la santé et le bien-être.

CUSTOMER BENEFITS

- A welcome environment that is clean and tidy.
- Noticeably more hygienic service fosters customer goodwill.
- Simple-to-use design allows customers to fill beverages and put on a lid using only one hand.

BENEFICIOS PARA LOS CLIENTES

- Un ambiente agradable, limpio y ordenado.
- Un servicio notablemente más higiénico fomenta la buena voluntad de los clientes.
- El diseño fácil de usar permite a los clientes llenar bebidas y poner la tapa usando una sola mano.

AVANTAGES POUR LE CLIENT

- Un cadre accueillant, propre et ordonné.
- Un service de toute évidence plus hygiénique dope les ventes.
- Utilisation simple et facile qui permet aux clients de remplir leur gobelet de boisson et de mettre le couvercle d'une seule main.

COST SAVINGS

- Fewer wasted lids adds up to more savings.
- Counters are kept free of stacks of new lids and messy rejected lids, requiring less labor for cleanup.

AHORROS

- Menos pérdidas de tapas significan más ahorro.
- Los mostradores se mantienen libres de pilas de tapas nuevas y tapas rechazadas, desordenadas, lo cual se traduce en menos trabajo de limpieza.

ÉCONOMIES

- Moins de couvercles gaspillés, ce qui se traduit par plus d'économies.
- Les comptoirs ne sont pas encombrés par des piles de couvercles neufs et des couvercles usagés et sales, ce qui demande moins de main-d'oeuvre pour le nettoyage.

UP TO 30% COST SAVINGS

AHORRAR HASTA UN 30% DE LOS COSTES
ÉCONOMISEUR DE 30% DES COÛTS



Lidsavers and cupdispensers 16.5

Dispensadores de tapas y vasos
Distributeur de couvercles et gobelets



Lidsaver™ 3

Assembly Montaje Montage

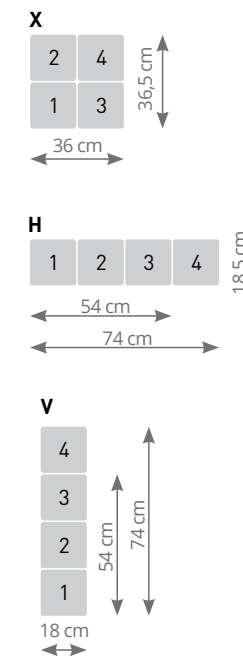

T1 (L)

Lids / Tapas / Couvercles
LS03 K / LS03 M

| Model / Modelo | Code / Código |
|-----------------------------|---------------|
| Berry™ DLT1310 Domed | AB |
| Berry™ DLT1310SS | AC |
| Berry™ DLT1402 Domed | AD |
| Berry™ DLT1402SS | AE |
| Berry™ DLT1408 Domed | AF |
| Berry™ DLT1408SS | AG |
| Dart® 16EL | AJ |
| Dart® 16LCDH | AK |
| Dart® 16RCL | AL |
| Dart® 16SL | AM |
| Dart® 20SL | AN |
| Dart® 20SLR | AO |
| Dart® 32SL | AP |
| Dart® 32SLR | AQ |
| Dixie® 9542 | AR |
| Dixie® 955 | JY |
| Dixie® TP9542 | AS |
| Dixie® TP9550 | JZ |
| International Paper LCRS 32 | AT |
| International Paper LCTS 44 | AU |
| Sweetheart® LGX12R | AY |
| Solo® 626 | AZ |
| Solo® DL626 | BB |
| Solo® DLR642 | BC |
| Solo® LD16A | BD |

T2 (C)

Cup dispenser
Dispensador vaso
Distributeur de gobelets

| REF | Code / Código | Type / Tipo | €/u |
|--------|---------------|--------------------|--------|
| INC-80 | A | Plastic / Plástico | 139,10 |
| CADJ-3 | D | St/Steel / Inox | 179,40 |

T3 (S)

Straw dispenser
Dispensador de pajitas
Distributeur de pailles

| REF | Code / Código | €/u |
|-----|---------------|--------|
| S1 | S | 121,20 |

T4 (P)

Condiment pocket
Apartado para condimentos
Casier à condiments

| REF | Code / Código | €/u |
|-----|---------------|--------|
| P1 | P | 121,20 |

For other lid models, consult your dealer.
Para otros modelos de tapa, consultar a su comercial.
Pour d'autres modèles de couvercles, consulter votre agent.



LS03 K Lids and cups dispenser display Mueble dispensador tapas y vasos Meuble distributeur couvercles et gobelets

REF + TYPE + CODE K4V-LLCC-AB-AD-A-A



| REF | Tipo / Type | Code / Código |
|-----|-------------|-------------------|
| K1 | L | T1 |
| K2H | LL | T1 + T1 |
| K2H | LC | T1 + T2 |
| K2V | LP | T1 + T4 |
| K3H | LLL | T1 + T1 + T1 |
| K3H | LCC | T1 + T2 + T2 |
| K3V | LCS | T1 + T2 + T3 |
| K3V | LCP | T1 + T2 + T4 |
| K4H | LCCC | T1 + T2 + T2 + T2 |
| K4H | LCCS | T1 + T2 + T2 + T3 |
| K4V | LCCP | T1 + T2 + T2 + T4 |
| K4V | LLCC | T1 + T1 + T2 + T2 |
| K4X | LCCC | T1 + T2 + T2 + T2 |
| K4X | LCCS | T1 + T2 + T2 + T3 |
| K4X | LCCP | T1 + T2 + T2 + T4 |
| K4X | LLCC | T1 + T1 + T2 + T2 |

LS03 M Vertical lids dispenser display Mueble dispensador tapas vertical Meuble distributeur couvercles vertical

REF + CODE M2V-LL-AB-AE



| REF | Code / Código | H cm |
|---------|--------------------|------|
| M1-L | +T1 | 18,5 |
| M2V-LL | +T1 + T1 | 36,5 |
| M3V-LLL | +T1 + T1 + T1 | 54,0 |
| M4V-4L | +T1 + T1 + T1 + T1 | 74,0 |

16.5 Lidsavers and cupdispensers

Dispensadores de tapas y vasos
Distributeur de couvercles et gobelets

KDS Lids and cups dispenser organizer display
Mueble dispensador tapas y vasos con organizador
Meuble distributeur couvercles et gobelets avec organisateur



| REF | Code / Código | H cm | 📦 |
|----------|---------------|------|---|
| K1LLDS | T1 | 42,5 | 1 |
| K2VLLCLS | T1 + T2 | 60,5 | 1 |
| K2VLLDS | T1 + T1 | 60,5 | 1 |
| K3VLLCLS | T1 + T2 + T2 | 78,5 | 1 |

Lidsaver™ 3 MINI

T5 (L)

Lids / Tapas / Couvercles
LS03J / LS03M

| Type / Tipo | Code Código |
|---------------------------------|-------------|
| Dart® Solo® P150 | M9 |
| Dart®/Solo® PL2 | N1 |
| Natureworks Inego PLA 3.085/310 | YQ |
| International Paper LCM-12S | D9 |
| International Paper LCWS12 | XE |
| International Paper LCRS 12 | EQ |
| International Paper LHSL-8 | XK |
| Pactiv YLP10C | ZD |
| Solo® L10BL | ST |
| Solo® PL4 | ZN |
| Solo® TL3-8 | IT |
| Solo®TLRN38 | ZM |
| Sweetheart® DLX8R | GV |
| SUP-10D | YT |
| Quick 6 Oz. BIS-H | YH |
| WinCup® 6L STYROLID | VG |

For other lid models, consult your dealer.
Para otros modelos de tapa, consultar a su comercial.
Pour d'autres modèles de couvercles, consulter votre agent.

LS03 Lids In-counter dispenser
Dispensador encastrable tapas
Distributeur encastrable couvercles

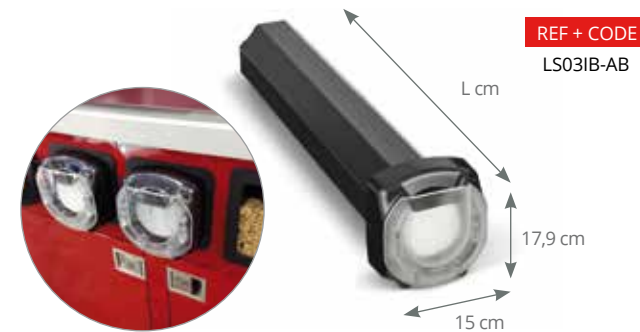

| REF | Code Código | Posiciones Posiciones | L cm | For / Para / Pour cm | 📦 |
|-----------|-------------|-----------------------|------|----------------------|---|
| LS03IB | T1 | H | 58,5 | 8,3 - 9,5 | 1 |
| LS03IVB | T1 | V | 58,5 | 8,3 - 9,5 | 1 |
| LS03PB | T1 | H | 58,5 | 9,7 - 12,1 | 1 |
| LS03PVB | T1 | V | 58,5 | 9,7 - 12,1 | 1 |
| LS03IS18B | T1 | H | 45,5 | 8,3 - 9,5 | 1 |
| LS03PS18B | T1 | H | 45,5 | 9,7 - 12,1 | 1 |

LS03 J Mini lid dispenser display
Mueble dispensador mini tapas
Meuble distributeur mini couvercles



| REF | Type / Tipo | Code / Código | B x H cm |
|-----|-------------|---------------|-------------|
| J1 | L | T5 | 13,5 x 19,1 |
| J2V | LL | T5 + T5 | 13,5 x 36,0 |
| J2H | LL | T5 + T5 | 28,5 x 19,1 |
| J3V | LLL | T5 + T5 + T5 | 13,5 x 52,5 |

LS03 M Mini lid In-counter dispenser
Dispensador encastrable mini tapas
Distributeur encastrable mini couvercles



| REF | Code / Código | Posiciones Posiciones | L cm | 📦 |
|------------|---------------|-----------------------|------|---|
| LS03MS18B | T5 | H | 45,5 | 1 |
| LS03MVS18B | T5 | V | 45,5 | 1 |

For / Para / Pour : 4,4 - 8,3 cm

Lidsavers and cupdispensers 16.5

Dispensadores de tapas y vasos
Distributeur de couvercles et gobelets

RSCL Lids and cups dispenser
Dispensador vasos y tapas
Distributeur gobelets et couvercles



| REF | L cm | Ø cm | For / Para / Pour cm | €/ u | 📦 |
|--------|------|-------|----------------------|--------|---|
| RSCL-4 | 38 | 101,5 | - | 390,15 | 1 |
| LD2-2 | 11 | 65,0 | 10,5 | 100,10 | 1 |
| LD3-2 | 13 | 65,0 | 12,4 | 118,70 | 1 |
| PLC-1 | 8 | 65,5 | 5,7 - 7,3 | 80,65 | 1 |
| PLC-2 | 9,5 | 65,5 | 7,3 - 8,9 | 91,30 | 1 |
| PLC-3 | 11 | 65,5 | 8,9 - 10,5 | 96,80 | 1 |

INC / CADJ Cup dispenser
Dispensador vaso
Distributeur de gobelets



| REF | L cm | Ø cm | For / Para / Pour cm | €/ u | 📦 |
|-----------|------|------|----------------------|--------|---|
| INC-80 | 58,5 | 13,5 | 5,7 - 12,1 | 139,10 | 1 |
| INC-80S18 | 46,0 | 13,5 | 5,7 - 12,1 | 140,95 | 1 |
| CADJ-1 | 56,0 | 13,5 | 6,4 - 8,9 | 162,20 | 1 |
| CADJ-2 | 56,0 | 14,5 | 7,6 - 9,8 | 175,55 | 1 |
| CADJ-3 | 56,0 | 17,5 | 7,6 - 11,7 | 179,40 | 1 |

3825 Straw dispenser
Dispensador de pajitas
Distributeur de pailles



| REF | W x D x H cm | €/ u | 📦 |
|---------|------------------|--------|---|
| 3805-06 | 31 x 36,7 x 17,8 | 110,00 | 1 |
| 3820-28 | 32 x 14 x 18 | 160,00 | 1 |

NEW!

16.5 Lidsavers and cupdispensers

Dispensadores de tapas y vasos
Distributeur de couvercles et gobelets

G58807 Countertop dispenser
Dispensador de mostrador
Distributeur de comptoir



4 adjustable cup dispenser
4 T-lid holder
1 straw holder

Dispensador ajustable de 4 tazas
Soporte para 4 tapas en T
1 portapajillas

4 distributeurs de gobelets réglables
4 porte-couvercle en T
1 porte-pailles

| REF | W x D x H cm | € / u | |
|--------|--------------------|----------|---|
| G58807 | 36,2 x 62,5 x 80,5 | 1.426,10 | 1 |

4830-06 Three-tier self-serve dispenser
Dispensador autoservicio de tres niveles
Distributeur libre-service à trois niveaux



| REF | W x D x H cm | € / u | |
|---------|----------------|-------|---|
| 4830-06 | 14,3 x 30 x 35 | 51,00 | 1 |

4842 Self-Serve dispenser system
Dispensador auto-servicio
Système distributeur libre-service



4842-01 4806-06

CTCL-4B Four-compartment countertop cup and lid organizer
Organizador de sobremesa de vasos y tapas con cuatro compartimentos
Présentoir de comptoir à quatre compartiments pour gobelets et couvercles



| REF | W x D x H cm | € / u | |
|---------|--------------------|--------|---|
| CTCL-4B | 15,4 x 57,2 x 53,3 | 259,00 | 1 |

CTFWH-8B Eight compartment flatware organizer
Organizador de cubiertos de 8 compartimentos
Range-couverts à 8 compartiments



| REF | W x D x H cm | € / u | |
|----------|------------------|--------|---|
| CTFWH-8B | 25,6 x 46 x 43,7 | 320,00 | 1 |

IDEA! Ideal for flatware, tea, condiment packets, salt, pepper, and products with high-volume usage.
Ideal para cubiertos, te, condimentos, sal, pimienta y para todo tipo de productos de mucha rotación.
Idéal pour couverts, thé, condiments, sel, poivre et toute sorte de produits à usage intensif.

| REF | Color / Colour | W x D x H cm | € / u | |
|---------|----------------|--------------------|-------|-------|
| 4806-01 | | 13 x 28,5 x 11 | 17,75 | 1 NEW |
| 4806-06 | | 13 x 28,5 x 11 | 17,40 | 1 |
| 4842-01 | | 14,3 x 40,6 x 35,2 | 82,00 | 1 NEW |

Lidsavers and cupdispensers 16.5

Dispensadores de tapas y vasos
Distributeur de couvercles et gobelets

CTNO Condiment dispensers
Dispensadores de condimentos
Distributeurs de condiments



*Adjustable compartments
Divisores ajustables
Compartiments réglables

CTNO-06

| REF | W x D x H cm | Capacity Capacidad Capacité | Napkin Servilletas Serviettes cm | € / u | |
|----------|--------------------|-----------------------------------|---|--------|---|
| CTNO-06* | 24,5 x 49,0 x 38,5 | 100 | 12,5 x 16,5 11,5-12,5 x 16,5 | 505,50 | 1 |

LDS Condiment dispensers
Dispensador de condimentos
Distributeur de condiments



CFIFO-4

CTC-3X2V



LDS-3

LDS-4CUP



| REF | W x D x H cm | € / u | |
|------------|--------------------|--------|-------|
| CFIFO-4 | 42,2 x 25,6 x 42 | 322,00 | 1 NEW |
| LDS-4CUP* | 29,5 x 53,5 x 51,5 | 386,20 | 1 |
| CTC-3X2V** | 29 x 27 x 41,5 | 294,60 | 1 |
| LDS-3 | 18,4 x 61 x 24,4 | 360,00 | 1 NEW |

* For lids and cups
Para tapas y vasos
Pour couvercles et gobelets
Ø 12 cm

**Adjustable dividers
Divisores ajustables
Séparateurs réglables

7512-06 Napkin holder
Servilletero
Porte-serviettes



7512-06



6512-06



6535-13

| REF | W x D x H cm | Capacity Capacidad Capacité | Napkin Servilletas Serviettes cm | € / u | |
|---------|--------------------|-----------------------------------|---|--------|-------|
| 7512-06 | 30,0 x 20,5 x 15,5 | 175 | | 191,65 | 1 |
| 6535-13 | 24,0 x 49,5 x 19,6 | 500 | 12,5 x 16,5 13,5 x 16,5 | 457,00 | 1 NEW |
| 6512-06 | 29,7 x 20,3 x 15,2 | 176 | | 178,25 | 1 NEW |

Index

Índice
Index

english

| ITEM | PAGE |
|---|---|
| ADAPTOR BAR..... | 192, 195 |
| ADJUSTABLE DISH CADDY..... | 261 |
| AIR POT..... | 506 |
| ANGLED ADAPTOR PLATE..... | 329 |
| ANTIMICROBIAL..... | 102, 103 |
| ANTI-SKID MAT TRAY ACCESSORIES..... | 501 |
| APPLE CORER..... | 138 |
| ASHTRAY..... | 383, 483 |
| BAIN MARIE..... | 50, 313, 318, 433 |
| BAKERY DISPLAY CASES..... | 396, 397 |
| BAR KEEP..... | 498, 500 |
| BAR KEEP®..... | 498 |
| BAR MATS..... | 498 |
| BAR SCOOP..... | 497 |
| BARRIER..... | 450 |
| BASE FOR BURNER..... | 85 |
| BASKET, BREAD..... | 473-477 |
| BASKET, WIRE..... | 390 |
| BEVERAGE TROLLEY..... | 489, 490 |
| BILL SPIKE..... | 482 |
| BIRD NEST MOULD..... | 100 |
| BLACK FIRST..... | 80 |
| BLACK PRO..... | 78-79 |
| BLACK SERIES..... | 60 |
| BLACK STEEL SPANISH PAELLA PAN..... | 84 |
| BLACKBOARDS..... | 451 |
| BOILER..... | 154 |
| BOWL..... | 221, 334, 337-339, 344-346, 348, 353-354, 356, 359-360, 362-363, 365-370, 380, 395, 437 |
| BOWLS, ANGLED BEEHIVE..... | 437 |
| BOWLS, DOUBLE WALL INSULATED SERVING..... | 221, 437 |
| BPA FREE GASTRONORM PAN..... | 204, 205 |
| BREATH GUARDS, MOBILE..... | 394 |
| BREATH GUARDS, MOBILE ACRYLIC..... | 394 |
| BRONZE COOKWARE..... | 400 |
| BRUSH..... | 159 |
| BUCKET WITH BASE..... | 146 |
| BUCKET-HOLDER STAND..... | 495 |
| BUCKET-HOLDER STAND..... | 493 |
| BUFFET CUBIC. BUFFET TROLLEY..... | 425-427 |
| BUFFET CUBIC. CUBES & SHELVES..... | 421 |
| BUFFET CUBIC. DISPLAY CASE..... | 419, 422, 423 |
| BUFFET DISPLAY..... | 339, 340, 395 |
| BUFFET FUEL..... | 432 |
| BUFFET STATION..... | 317 |
| BUFFET WINE COOLER. CUBIC..... | 418 |
| BUTTER SPREADER..... | 114 |
| CAKE DIVIDER..... | 160 |
| CAKE MOULD..... | 163-165, 169, 182 |
| CAKE SERVER..... | 114, 442, 444 |
| CAKE STAND..... | 161 |
| CAN OPENER..... | 138 |
| CARAMEL CREAM MOULD..... | 169 |
| CARAMELIZER..... | 160 |
| CARD HOLDER..... | 484 |
| CARRY-SKEWERS..... | 35, 482 |
| CASSEROLE..... | 60 |
| CASSEROLE BLACK SERIES..... | 60 |

| ITEM | PAGE |
|--|--|
| CAST IRON MINIATURE..... | 460-461 |
| CATERING BAGS..... | 216, 217 |
| CAYENNE®..... | 312-313 |
| CAYENNE® WARMERS & RETHERMALIZERS..... | 310-314 |
| CENTURY..... | 58, 59 |
| CEREAL DISPENSER..... | 435 |
| CHAFERS..... | 428-431 |
| CHAFERS ACCESSORIES..... | 429, 432, 434 |
| CHAFERS, ECONOMY..... | 431 |
| CHAFERS, INTRIGUE®..... | 429 |
| CHALKMARKERS..... | 451 |
| CHAMPAGNE BUCKET..... | 491, 492, 494, 495 |
| CHAMPAGNE STOPPER..... | 500 |
| CHARCOAL OVEN..... | 29-31 |
| CHECK MINDER..... | 124 |
| CHIMNEY..... | 28 |
| CHINESE COLANDER..... | 116 |
| CHIP BAGGER..... | 111 |
| CHOCOLATE FOUNTAIN..... | 318 |
| CLEAR GN LIDS..... | 341, 397 |
| CLEARING TROLLEY..... | 245, 246 |
| CLIP TAGS..... | 228, 234, 235, 239, 240 |
| COCKTAIL SERVICE..... | 496, 497 |
| COCKTAIL SPOON..... | 497 |
| COCKTAIL STRAINER..... | 497 |
| COFFE MAKER..... | 505 |
| COFFE POT..... | 502-505 |
| COLANDER..... | 115-116 |
| COLANDER..... | 117 |
| COLORLED COOKWARE..... | 55 |
| COMPLETE KITS OF SHELVING..... | 268-277 |
| CONDIMENT HOLDER..... | 499 |
| CONFECTIONERY FUNNEL..... | 162 |
| CONICAL SAUCEPAN..... | 46, 50, 59 |
| CONTACT GRILL..... | 301 |
| COOL • LINE..... | 55, 71 |
| COOLING PLATE..... | 433 |
| CORKSCREW..... | 500, 502 |
| COUNTER-TOP DISPENSER..... | 258, 427 |
| COUNTERTOP MIXERS..... | 302 |
| COUSCUS SET..... | 51 |
| COVERS, PLASTIC PLATE..... | 485 |
| COVERS, PLATE..... | 485 |
| CREAMER..... | 502-504 |
| CRÊPE MAKER..... | 294 |
| CUBE CUTTER..... | 135 |
| CUBED-GLASS DISPLAY CASES..... | 321 |
| CUP..... | 221, 369 |
| CUTLERY BIN..... | 223 |
| CUTLERY DISPENSER FOR SERVING TROLLEY..... | 246 |
| CUTTING BOARD..... | 140-142 |
| CUTTING BOARD TABLE..... | 140-142 |
| CUTTING BOARD VIOLET..... | 142 |
| DELIVERY BACKPACKS..... | 218-219 |
| DICER & SLICER..... | 129, 130 |
| DISHES..... | 221, 334-336, 338, 344-350, 353-357, 360-361, 368, 370 |
| DISHES, COLORED..... | 336, 357 |
| DISPENSER AND DISPOSABLE COVERS..... | 250 |

english

| ITEM | PAGE |
|---|--|
| DISPENSERS..... | 162, 434, 435 |
| DISPENSING SOLUTIONS..... | 510-515 |
| DISPLAY CABINET..... | 402 |
| DISPLAY COOKWARE..... | 408-411 |
| DISPLAY SLATES..... | 466-467 |
| DISPLAY STANDS..... | 386, 391-393 |
| DISPLAY TRAY..... | 335, 340, 341, 345, 351, 371, 380, 395, 420, 467 |
| DISPLAYER MELAMINE BOWLS. CUBIC..... | 421 |
| DOUBLE CUTTER..... | 158, 166-168 |
| DOUBLE FAST-FOOD TRAY TROLLEY..... | 256 |
| DOUBLE WALL INSULATED COOLER..... | 493 |
| DREGDERS..... | 123 |
| DROP-IN..... | 289, 293 |
| EGG RING..... | 119 |
| EGG SLICER..... | 138 |
| ELECTRIC HEATING UNIT FOR CHAFING DISH..... | 432 |
| ELECTRIC SLICING MACHINE..... | 303 |
| ELEGANCE..... | 355 |
| ENAMELLED GAS BURNIER..... | 85 |
| ENAMELLED STEEL MINATURES..... | 458 |
| ENAMELLED STEEL PAELLA PAN..... | 84 |
| EPP BOX..... | 213 |
| FAST-FOOD TURNER..... | 113 |
| FISH SCALER..... | 124 |
| FISH TURNER..... | 99, 113 |
| FLAP IDENTIFICATION..... | 227 |
| FLAP-RACK®..... | 227, 228 |
| FLARED SAUCE CUPS..... | 479 |
| FLATWARE BASKET..... | 237 |
| FOOD PAN | 155, 201, 318, 345, 349-350, 355, 365, 370, 409, 429, 438, 461 |
| FOOD-PROCESSORS..... | 302-303 |
| FORK..... | 101, 103, 441-443, 446 |
| FRENCH FRY CUTTER..... | 131 |
| FRENCH STYLE SAUCEPAN..... | 49 |
| FRUIT & VEGETABLE SLICER..... | 133 |
| FRY PAN "LYONNAISE"..... | 83 |
| FRY PAN ALUMINIUM..... | 73-76 |
| FRY PAN BLACK SERIES..... | 78 |
| FRY PAN BLINIS..... | 76 |
| FRY PAN CAST ALUMINIUM..... | 78-80 |
| FRY PAN COOL • LINE..... | 71 |
| FRY PAN CRÊPE..... | 79, 80 |
| FRY PAN DEEP ENAMELLED WITH HANDLES..... | 84 |
| FRY PAN IDEA..... | 72 |
| FRY PAN MULTIMETAL..... | 69 |
| FRY PAN PUJADAS 1921..... | 81 |
| FRY PAN ST/STEEL..... | 70-72 |
| FRY PANS..... | 62-83, 408 |
| FRYER..... | 295 |
| FUNNEL..... | 118, 162 |
| GASTRONORM CONTAINERS (MELAMINE)..... | 374-378 |
| GASTRONORM CONTAINERS (POLYCARBONATE)..... | 202-203 |
| GASTRONORM CONTAINERS (POLYPROPYLENE)..... | 206-207 |
| GASTRONORM ENAMELLED STEEL..... | 399 |
| GASTRONORM FOR DEFROST TROLLEY..... | 254 |
| GASTRONORM SANDWICH BOTTOM..... | 189, 199, 401 |
| GASTRONORM ST/STEEL..... | 194-197 |

Index

Índice
Index

| ITEM | PAGE |
|---------------------------------|--|
| GASTRONORM STAND..... | 198, 223, 379, 417 |
| GASTRONORM VIOLET..... | 208 |
| GLASS..... | 221, 356, 457, 496 |
| GLOVES..... | 149 |
| GN BAMBOO BOX..... | 391 |
| GN HERMETIC LID..... | 33, 197 |
| GN HERMETIC LID EASY OPEN..... | 197 |
| GN PASTRY PAN..... | 154 |
| GN TRANSPORT TROLLEY..... | 250-252, 258 |
| GRANITE-SLATE DISPLAYER..... | 373 |
| GRATER..... | 120-121 |
| GRAVY BOAT..... | 479 |
| GRID GN..... | 92 |
| GRID PASTRY..... | 88 |
| GRILL..... | 79, 80 |
| GRILL..... | 27-37 |
| GRILLBOX LID..... | 28 |
| GRIPPER..... | 28, 95, 99, 111, 113-114, 144, 342, 442, 444, 465, 497 |
| HEART RING MOULD..... | 168 |
| HEATING LAMPS..... | 315-317 |
| HEATING PLATE..... | 318 |
| HEMISPHERICALD MOULD..... | 155 |
| HEXAGON MOULD..... | 168 |
| HOOK..... | 118 |
| HOT CUPBOARD..... | 321 |
| HOT TRAY WARMER..... | 257, 321 |
| HOT-PLATE WITH HANDLES..... | 79 |
| ICE BUCKET..... | 493 |
| ICE CREAM CONTAINERS..... | 153 |
| ICE CREAM CUP..... | 153 |
| ICE CREAM SCOOP..... | 152 |
| ICE-CREAM CHURN..... | 326 |
| ICE-CREAM PARLOUR..... | 150-151, 322-327 |
| INDUCTION HOB..... | 284-293 |
| INFORMATION SIGN..... | 450 |
| INOX-PRO..... | 46-53 |
| INSTITUTIONS..... | 220-223 |
| INSULATED COFFE POT..... | 507 |
| ISOTHERMAL TRAY..... | 256 |
| JIGGER..... | 497 |
| JUICE DISPENSER..... | 435 |
| KITCHEN BOWL..... | 155 |
| KITCHEN TIMER ALARM..... | 147 |
| KITS. CUBIC..... | 415-417 |
| KNIFE..... | 441, 443, 446 |
| KNIFE / WHEEL (SPARE PART)..... | 138 |
| LADLE..... | 98, 369, 441-445 |
| LARGE TRAY HOLDER..... | 482 |
| LEMON SQUEEZER..... | 497 |
| LID FOR BREAKFAST CUP..... | 221 |
| LID FOR COOKWARE..... | 33, 49, 399 |
| LID GN..... | 33, 197, 203, 205, 207-208 |
| LID INOX-PRO..... | 49 |
| LID RACKS..... | 236 |
| LIDSAVER®..... | 510-515 |
| LOBSTER CRACKER..... | 449 |
| MANDOLINES..... | 139 |
| MANUAL FOOD PROCESSORS..... | 129-139 |

| ITEM | PAGE |
|------------------------------------|---------------------------------------|
| MARBLE OBLONG DISPLAY PLATE..... | 373 |
| MATS..... | 149 |
| MEASURING CUP..... | 145, 146 |
| MEASURING CUPS..... | 145 |
| MEASURING JUG..... | 146 |
| MEASURING JUG..... | 146 |
| MEASURING SCOOP..... | 144 |
| MEASURING SPOON..... | 144, 145 |
| MEAT BEATER..... | 119 |
| MEDITERRANEAN..... | 356 |
| MELAMINE FOR PRESENTATION..... | 334-383 |
| MELAMINE MINIATURES..... | 380-382 |
| MELAMINE SLIM..... | 376-377 |
| MENU HOLDER..... | 484 |
| METAL WIRE BASKET..... | 471 |
| METALLIC BRUSH..... | 124 |
| MICRO-WAVES..... | 294 |
| MILK DISPENSER..... | 434, 435 |
| MINIATURE CAST ALUMINIUM..... | 459 |
| MIRAGE®..... | 292-293, 306-309 |
| MIRAGE® 3D INDUCTION..... | 306-307 |
| MIRAGE® INDUCTION WARMER..... | 293 |
| MIRAMAR®..... | 408-411 |
| MIRAMAR® DISPLAY COOKWARE..... | 406-409 |
| MIXERS..... | 302, 303 |
| MIXING PADDLE..... | 124 |
| MOULDS "FLEXIPAN"..... | 175-181 |
| MULTIMETAL..... | 50, 77 |
| NAPKIN HOLDER..... | 419, 483, 515 |
| NAPKIN HOLDER. CUBIC..... | 419 |
| NATURAL BAMBOO & WOOD..... | 468, 469 |
| NON SLIP SERVING TRAY..... | 482, 501 |
| NON-SMOKING SING..... | 481 |
| NON-STICK SILICONE MAT..... | 95 |
| NUMBER CARD HOLDER..... | 481 |
| NUT CRACKER..... | 449 |
| OIL POURER..... | 124 |
| ONION CUTTER..... | 133 |
| OVAL MOULD..... | 165, 168 |
| OVAL SERVING DISH..... | 345, 349-350, 355, 365, 370, 438, 461 |
| OVAL SERVING TRAY..... | 482 |
| OVEN MITT..... | 149 |
| OVENS..... | 29-31, 294 |
| PAELLA PAN ALUMINIUM..... | 73 |
| PAELLA PAN INOX-PRO ST/STEEL..... | 48 |
| PAN BAND..... | 198 |
| PASTA COLANDER..... | 52 |
| PASTRY BAGS..... | 170 |
| PASTRY MOULDS..... | 163-165, 167-169, 177-189 |
| PASTRY TORCH..... | 160 |
| PEPPER MILL..... | 481 |
| PERFORATED BOTTOMS GASTRONORM..... | 195, 196, 203, 205, 254 |
| PIZZA BAGS..... | 214, 215 |
| PIZZA BAKING SHEETS..... | 93 |
| PIZZA MOULD..... | 93 |
| PIZZA PAN..... | 93, 94 |
| PIZZA PEEL..... | 95 |
| PIZZA WHEEL..... | 113 |

| ITEM | PAGE |
|---|---|
| SNACK BOWL SET..... | 344, 352, 360, 380, 382, 479 |
| SOUP KETTLE..... | 314 |
| SOUP TOUREEN..... | 439 |
| SPATULA..... | 99, 112, 113, 157, 441-446 |
| SPECIAL TROELLYS..... | 257-261 |
| SPOODLE®..... | 102-103, 105 |
| SPOON..... | 100, 101, 103-105, 157, 369, 380, 441-446 |
| SPOONS..... | 441-443, 444-446 |
| SQUEEZE DISHER..... | 104 |
| SQUEEZE DISPENSER..... | 122, 123 |
| ST/STEEL SELF-SERVICE TRAY..... | 222 |
| STAINLESS STEEL MINIATURES..... | 454-456 |
| STAINLESS STEEL PLATE COVERS..... | 485 |
| STAND FOR CHINESE COLANDER OR FUNN..... | 116 |
| STAND FOR CUTTING BOARDS..... | 202 |
| STAND FOR GN CONTAINERS..... | 198, 379 |
| STAND FOR GN LIDS..... | 202 |
| STEAM POT INOX-PRO..... | 52 |
| STOCK POT ALUMINIUM..... | 56-59 |
| STOCK POT COOL • LINE..... | 52 |
| STOCK POT INOX-PRO..... | 48, 44 |
| STOCK POT WITH TAP..... | 52 |
| STONE..... | 354 |
| SUGAR BOWL..... | 503 |
| SUPER PAN® 3..... | 201 |
| SUPER PAN® SUPER SHAPES..... | 200-201 |
| SUPPORT FOR CUTLERY DISPENSER..... | 223, 237, 257, 420, 427 |
| SUPPORT FOR PASTRY BAGS..... | 170 |
| TABLE CADDY..... | 480 |
| TABLE CRUMBER..... | 483 |
| TABLE NUMBER..... | 481 |
| TABLE SING "RESERVED"..... | 481 |
| TABLE-TIDY..... | 483 |
| TEA POT..... | 503, 504-505 |
| TEA POT WITH FILTER..... | 504 |
| TEA&SUGAR BAGS DISPENSER. CUBIC..... | 419 |
| TEAR MOULD..... | 168 |
| TEMPLATES..... | 41, 410-411 |
| TERRACOTA..... | 352-353 |
| THERMOMETER..... | 147-148 |
| THREE LEVELS STAND. CUBIC..... | 417 |
| TIN PLATES DISPLAY..... | 464-465 |
| TOASTER..... | 296-300 |
| TOMATOES SLICER..... | 137 |
| TONG..... | 35, 95, 107-110, 168, 446, 447-449, 469, 497 |
| TONG. BUTCHER'S..... | 449 |
| TONG. CAKE..... | 448 |
| TONG. UTILITY..... | 108-109, 447 |
| TONGS, SERVING..... | 447 |
| TRAY..... | 89-92, 220, 222-223, 335, 340-341, 343-344, 350-355, 360, 362, 364-367, 371-372, 380, 382 |
| TRAY (FAST-FOOD)..... | 222 |
| TRAY (GASTRONORM)..... | 89, 367, 465 |
| TRAY (NON-STICK ALUMINIUM)..... | 89, 91 |
| TRAY (PASTRY)..... | 90-92, 351 |
| TRAYS, FIBERGLASS..... | 222 |
| TRIANGLE CAKE MOULD..... | 169 |
| TRIBUTE..... | 45, 69 |

| ITEM | PAGE |
|---|--------------------|
| TROLLEY (ALUMINIUM SERVING)..... | 245 |
| TROLLEY (DEFROST WITH RAIL)..... | 254 |
| TROLLEY (DISASSEMBLED SERVING TROLLEY)..... | 248 |
| TROLLEY (DISASSEMBLED WITH RAIL)..... | 251-253 |
| TROLLEY (GUERIDON)..... | 426 |
| TROLLEY (INOX SERVING)..... | 246-249, 255 |
| TROLLEY (PLASTIC)..... | 244, 245, 260, 261 |
| TROLLEY (RAIL)..... | 250-257 |
| TROLLEY (STACKABLE)..... | 251, 252 |
| TROLLEY (WOODEN)..... | 425-427 |
| TROLLEY FOR DISHWASER RACKS..... | 259-260 |
| TROLLEY FOR HEAVY LOADS..... | 259 |
| TROLLEY WITH WORKING TOP..... | 258 |
| TUBE..... | 171-174 |
| T-VERSION..... | 228-233 |
| UNIVERSAL STOPPER..... | 500 |
| VEGETABLE SCRAPER..... | 140 |
| VEGETABLE SIEVE..... | 118 |
| VERSATIL MACHINE..... | 135 |
| VERSATILE MANUAL PROCESSOR..... | 137 |
| VINYL RACK COVER..... | 261 |
| VIOLET COLLECTION..... | 208 |
| WALL-MOUNTED COWKSCREW..... | 502 |
| WARMERS..... | 313, 314 |
| WATER PITCHER..... | 508-509 |
| WEDGER..... | 134 |
| WHISK..... | 156 |
| WHITE WOOD SERVING TRAY..... | 371 |
| WINE BUCKETS..... | 491, 492, 494, 495 |
| WINE COMPLEMENTS..... | 500 |
| WINE COOLER..... | 495 |
| WIRE SKIMMER..... | 100 |
| WOK (ST/STEEL)..... | 72 |
| WOK BLAC SERIES..... | 79 |
| WOK MULTIMETAL..... | 77 |
| WOK STEEL..... | 83 |
| WOK STEEL PRO..... | 81 |
| WOOD SERVING BOARDS..... | 462 |
| WOODEN BOX..... | 387 |

Index

Índice

Index

| ARTÍCULO | PÁGINA |
|--|-------------------|
| ABRELATAS INDUSTRIAL | 138 |
| ALCUZA..... | 124 |
| ALFOMBRA DE BAR PAR ESCURRIR COPAS..... | 498 |
| ALFOMBRAS..... | 149 |
| ANILLO ANTI-GOTEO..... | 500 |
| ANTIMICROBIAL | 102, 103 |
| APLASTACARNES..... | 119 |
| ARAÑA | 100 |
| ARMARIO CALIENTE..... | 321 |
| ARO | 167 |
| ASADOR GRILL..... | 79, 80 |
| AZUCARERO | 503 |
| BALANZA..... | 147 |
| BAMBÚ NATURAL & MADERA..... | 468, 469 |
| BANDA SELLADORA SILICONA..... | 198 |
| BANDEJA..... 89-92, 220, 222-223, 335, 340-341, 343-344, 350-355, 360, 362, 364-367, 371-372, 380, 382 | |
| BANDEJA ALUMINIO ANTIADHERENTE | 89, 91 |
| BANDEJA AUTO-SERVICE ACERO INOX..... | 222 |
| BANDEJA FAST-FOOD | 222 |
| BANDEJA GASTRONORM..... | 89, 367, 465 |
| BANDEJA ISOTÉRMICA | 256 |
| BANDEJA OVAL | 482 |
| BANDEJA PASTELERÍA..... | 90-92, 351 |
| BANDEJA PORTACUBIERTOS | 223 |
| BANDEJA PRESENTACIÓN ...335, 340, 341, 345, 351, 371, 380, 395, 420, 467 | |
| BANDEJA SERVICIO | 388, 389, 501 |
| BANDEJAS ANTI-DESGLIZANTES | 482, 501 |
| BANDEJAS FIBRA DE VIDRIO | 222 |
| BANDEJAS PARA PIZZA..... | 93 |
| BANDEJAS. CUBIC..... | 416-418, 420 |
| BAÑO MARÍA..... | 50, 313, 318, 433 |
| BAR KEEP®..... | 498 |
| BARRA DE NOTAS..... | 124 |
| BASE PIZZA | 93, 94 |
| BATERÍA BRONCE..... | 400 |
| BATERIA COLOR | 55 |
| BATERÍA MIRAMAR® | 406-409 |
| BATERIA PRESENTACIÓN..... | 408-411 |
| BATIDOR | 156 |
| BATIDORA SOBRE MESA..... | 302 |
| BATIDORAS PLANETARIAS | 302, 303 |
| BLACK FIRST | 80 |
| BLACK PRO | 78-79 |
| BLACK SERIES..... | 60 |
| BOL.. 221, 334, 337-339, 344-346, 348, 353-354, 356, 359-360, 362-363, 365-370, 380, 395, 437 | |
| BOL DOBLE PARED | 221, 437 |
| BOL ESTRIDADO INCLINADO | 437 |
| BOLSAS DE CATERING..... | 216, 217 |
| BOLSAS PARA PIZZAS | 214, 215 |
| BOQUILLA..... | 171-174 |
| BOQUILLA POLICARBONATO..... | 174 |
| BOTELLA BAR | 498, 500 |
| BRASA | 27-37 |
| BUFFET CUBIC. CARRO BUFFET | 425-427 |
| BUFFET CUBIC. CUBOS Y ESTANTES..... | 421 |

español

| ARTÍCULO | PÁGINA |
|--|--------------------|
| BUFFET CUBIC. MUEBLE EXPOSITOR..... | 419, 422, 423 |
| CACEROLA ALUMINIO..... | 58 |
| CACEROLA COOL • LINE..... | 55 |
| CACEROLA INOX-PRO | 48 |
| CACILLO..... | 98, 369, 441-445 |
| CADDY DE MESA | 480 |
| CAFETERA..... | 502-505 |
| CAJA CONDIMENTOS..... | 499 |
| CAJA DE MADERA | 387 |
| CAJA GN BAMBU | 391 |
| CAJA PPE..... | 213 |
| CALDERO..... | 154 |
| CALENTADOR DE PLATOS | 257, 321 |
| CALENTADOR INDUCCIÓN MIRAGE | 293 |
| CALENTADORES | 313, 314 |
| CARRO BEBIDAS | 489, 490 |
| CARRO CON GUIAS..... | 250-257 |
| CARRO CON GUIAS, DESMONTABLE | 251-253 |
| CARRO CON GUIAS, ENCASTRABLE | 251, 252 |
| CARRO CON SUPERFICIE DE TRABAJO..... | 258 |
| CARRO DE MADERA..... | 425-427 |
| CARRO DE PLÁSTICO | 244, 245, 260, 261 |
| CARRO DE SERVICIO DESMONTABLE | 248 |
| CARRO DE SERVICIO EN ALUMINIO | 245 |
| CARRO DE SERVICIO INOXIDABLE..... | 246-249, 255 |
| CARRO DESCONGELACIÓN..... | 254 |
| CARRO DESEMBARACE | 245, 246 |
| CARRO DOBLE PARA BANDEJAS FAST-FOOD..... | 256 |
| CARRO GASTRONORM DESCONGELACIÓN..... | 254 |
| CARRO GUERIDON | 426 |
| CARRO PARA CARGAS PESADAS..... | 259 |
| CARRO PARA CESTAS | 259-260 |
| CARRO PARA PLATOS AJUSTABLE | 261 |
| CARRO PORTA CUBETAS GASTRONORM | 250-252, 258 |
| CARRO PORTACUBIERTOS..... | 258, 427 |
| CARROS ESPECIALES | 257-261 |
| CASCANUECES..... | 449 |
| CAYENNE®..... | 312-313 |
| CAZO ALUMINIO | 59 |
| CAZO BOMBEADO | 46, 50, 59 |
| CAZO COOL • LINE | 55 |
| CAZO INOX-PRO | 49-50 |
| CAZO TIPO FRANCÉS | 49 |
| CAZOS DE MEDIDAS..... | 145 |
| CAZUELA ALUMINIO FUNDICIÓN | 60 |
| CAZUELA BLACK SERIES..... | 60 |
| CEDAZO | 161 |
| CENICERO | 383, 483 |
| CENTURY..... | 58, 59 |
| CEPILLO METÁLICO | 124 |
| CESTA GRANDES BANDEJAS | 240 |
| CESTA METAL | 471 |
| CESTA PAN..... | 473-477 |
| CESTA PARA BANDEJAS ISOTÉRMICAS | 240 |
| CESTA PARA CUBIERTOS | 236, 237, 477 |
| CESTA REJADA | 390 |
| CESTA UNIVERSAL | 236 |
| CESTAS ABIERTAS..... | 230-233 |

español

| ARTÍCULO | PÁGINA |
|--|---|
| CESTAS CERRADAS..... | 234, 235 |
| CESTAS PARA PLATOS..... | 238-240 |
| CESTAS POLIPROPILENO | 474-477 |
| CESTILLO PARA CUBIERTOS..... | 237 |
| CHAFING , ACCESORIOS | 429, 432, 434 |
| CHAFING DISH | 428-431 |
| CHAFING DISHEES ECONOMICOS..... | 431 |
| CHAFING DISHES INTRIGUE..... | 429 |
| CHAMPAÑERA | 491, 492, 494, 495 |
| CHAMPAÑERA, COMPLEMENTOS..... | 500 |
| CHIMENEA | 28 |
| CINTA PVC PARA MOUSSE | 168 |
| CLIP DE IDENTIFICACIÓN..... | 228, 234, 235, 239, 240 |
| COCTEL | 496, 497 |
| COCTELERA..... | 496 |
| COLADOR..... | 115-116 |
| COLADOR CHINO..... | 116 |
| COLADOR GUSANILLO..... | 497 |
| COLAPASTAS | 52 |
| COLECTIVIDADES | 220-223 |
| CONJUNTOS COMPLETOS DE ESTANTERIAS | 268-277 |
| CONJUNTOS. CUBIC | 415-417 |
| COOL • LINE..... | 55, 71 |
| COPA HELADO..... | 153 |
| CORTADOR / DESCORAZONADOR MANZANAS..... | 138 |
| CORTADOR DE CEBOLLAS | 133 |
| CORTADOR DE LECHUGA..... | 132 |
| CORTADOR DE PATATAS FRITAS..... | 131 |
| CORTADOR EN CUBOS | 135 |
| CORTADOR SECCIONADOR..... | 134 |
| CORTADOR TOMATES..... | 137 |
| CORTADORA ELÉCTRICA DE FIAMBRES | 303 |
| CORTADOR-REBANADOR..... | 129, 130 |
| CORTAHUEVOS..... | 138 |
| CORTAPASTAS | 158, 166-168 |
| CRÊPERA..... | 294 |
| CUBERTERO PARA CARRO SERVICIO | 246 |
| CUBETA GASTRONORM SIN BPA..... | 204, 205 |
| CUBETAS HELADERÍA | 153 |
| CUBITERA DE PLÁSTICO..... | 494-495 |
| CUBO CHAMPÁN | 491, 492, 494, 495 |
| CUBO CON BASE..... | 146 |
| CUBO HIELO..... | 493 |
| CUCHARA..... | 100, 101, 103-105, 157, 369, 380, 441-446 |
| CUCHARA BATIDORA | 497 |
| CUCHARA MEDIDORA | 144, 145 |
| CUCHARA SERVICIO..... | 441-443, 444-446 |
| CUCHILLA/RODILLO DE RECAMBIO..... | 138 |
| CUCHILLO | 441, 443, 446 |
| CUSCUSERA..... | 51 |
| DISPENSADOR A PRESIÓN | 122, 123 |
| DISPENSADOR BOLSAS TE Y AZÚCAR. CUBIC..... | 419 |
| DISPENSADOR CON CONTROL DE PORCIONES | 162 |
| DISPENSADOR DE CEREALES..... | 435 |
| DISPENSADOR DE ZUMOS..... | 435 |
| DISPENSADOR LECHE | 434, 435 |
| DISPENSADOR Y FUNDAS DESECHABLES | 250 |
| DISPENSADORES..... | 162, 434, 435 |

Index

Índice

Index

| ARTÍCULO | PÁGINA |
|--|---------------------------------------|
| DOSIFICADOR LICOR..... | 497 |
| ELEGANCE..... | 355 |
| ELEMENTO ELÉCTRICO CHAFING DISH..... | 432 |
| EMBUDO..... | 118, 162 |
| EMBUDO DOSIFICADOR..... | 162 |
| ENFRIADOR BOTELLAS BUFFET. CUBIC..... | 418 |
| ENFRIADOR ISOTÉRMICO..... | 493 |
| ENSALADERA ACRÍLICA..... | 439 |
| ESCAMADOR | 124 |
| ESCURRIDERA | 117 |
| ESPÁTULA | 99, 112, 113, 157, 441-446 |
| ESPÁTULA PARA UNTAR | 114 |
| ESPECIEROS..... | 123 |
| ESPUMADERA | 99, 100, 441-444 |
| ESTACION BUFFET TRINCHANTE | 317 |
| ESTANTERÍAS..... | 268-277 |
| EXPOSITOR BOLLERIA..... | 396, 397 |
| EXPOSITOR BUFFET | 339, 340, 395 |
| EXPOSITOR DE TARTAS..... | 161 |
| EXPOSITOR GASTRONORM | 198, 223, 379, 417 |
| EXPOSITOR TRES NIVELES. CUBIC | 417 |
| EXPOSITORES..... | 386, 391-393 |
| EXPRIME LIMONES..... | 497 |
| FLANERO | 169 |
| FLAP IDENTIFICACIÓN..... | 227 |
| FLAP-RACK® | 227, 228 |
| FONDOS PERFORADOS GASTRONORM | 195, 196, 203, 205, 254 |
| FREIDORA..... | 295 |
| FUEL PARA CHAFING DISH..... | 432 |
| FUENTE. 155, 201, 318, 345, 349-350, 355, 365, 370, 409, 429, 438, 461 | |
| FUENTE FONDUE CHOCOLATE..... | 318 |
| FUENTE HONDA CÓNICA..... | 155 |
| FUENTE OVAL..... | 345, 349-350, 355, 365, 370, 438, 461 |
| FUNDA PROTECTORA DE VINILO..... | 261 |
| GANCHO | 118 |
| GASTRONORM ACERO ESMALTADO | 399 |
| GASTRONORM FONDO DIFUSOR | 189, 199, 401 |
| GASTRONORM INOXIDABLE | 194-197 |
| GASTRONORM MELAMINA..... | 374-378 |
| GASTRONORM POLICARBONATO | 202-203 |
| GASTRONORM POLIPROPILENO | 206-207 |
| GASTRONORM VIOLET | 208 |
| GEL LUBRICANTE SANITARIO | 139, 303 |
| GN PASTRY PAN | 154 |
| GRILL DE CONTACTO | 301 |
| GUANTES PROTECCIÓN | 149 |
| HELADERÍA | 150-151, 322-327 |
| HERVIDOR DE ARROZ..... | 294 |
| HORNOS | 29-31, 294 |
| HORNOS DE BRASA..... | 29-31 |
| INDUCCIÓN 3-D MIRAGE..... | 306-307 |
| INOX-PRO..... | 46-53 |
| INSERTOS..... | 289, 293 |
| JARRA | 507 |
| JARRA AGUA | 508-509 |
| JARRA DE MEDIDAS..... | 146 |
| JARRA MEDIDORA | 146 |
| JARRA PARA INFUSIONES | 505 |

Index

Índice

Index

| ARTÍCULO | PÁGINA |
|---|---------------------------|
| JARRA POLICARBONATO | 509 |
| JARRA TERMO..... | 507 |
| LÁMPARAS MANTENEDORAS..... | 315-317 |
| LECHERA | 502-504 |
| LIBRADOR | 152, 155, 497 |
| LIDSAVER®..... | 510-515 |
| LLAUNAS PRESENTACIÓN..... | 464-465 |
| MANDOLINAS | 139 |
| MANGAS PASTELERAS | 170 |
| MANOPLA..... | 149 |
| MANTA ENFRIADORA..... | 495 |
| MANTECADORA..... | 326 |
| MANTEL ANTIDESLIZANTE PARA BANDEJA..... | 501 |
| MANTELES INDIVIDUALES..... | 478 |
| MARCADOR DE TARTAS..... | 160 |
| MARCADORES TIZA..... | 451 |
| MARCOS PARA BANDEJAS..... | 90 |
| MEDITERRANEAN..... | 356 |
| MELAMINA PRESENTACIÓN | 334-383 |
| MELAMINA SLIM..... | 376-377 |
| MESA DE CORTE..... | 140-142 |
| MICRO-ONDAS | 294 |
| MINIATURAS ACERO ESMALTADO..... | 458 |
| MINIATURAS ALUMINIO FUNDICIÓN | 459 |
| MINIATURAS HIERRO FUNDIDO..... | 460-461 |
| MINIATURAS INOXIDABLE..... | 454-456 |
| MINIATURAS MELAMINA..... | 380-382 |
| MIRAGE®..... | 292-293, 306-309 |
| MIRAMAR®..... | 408-411 |
| MOCHILA DE REPARTO..... | 218-219 |
| MOLDE CAKE..... | 163-165, 169, 182 |
| MOLDE FORMA CORAZÓN | 168 |
| MOLDE FORMA LÁGRIMA..... | 168 |
| MOLDE HEXAGONAL..... | 168 |
| MOLDE HUEVO..... | 119 |
| MOLDE MEDIA CAÑA | 169 |
| MOLDE NIDO | 100 |
| MOLDE OVAL | 165, 168 |
| MOLDE PARA PIZZA..... | 93 |
| MOLDE SEMIESFÉRICO | 155 |
| MOLDES "FLEXIPAN"..... | 175-181 |
| MOLDES DE SILICONA | 182-185 |
| MOLDES PASTELERÍA | 163-165, 167-169, 177-189 |
| MOLDES SILICONA 600 X 400..... | 184-185 |
| MOLINILLO PIMIENTA..... | 481 |
| MOLINILLO SAL | 481 |
| MULTIMETAL..... | 50, 77 |
| NÚMERO MESA | 481 |
| OLLA ALUMINIO..... | 56-59 |
| OLLA CON GRIFO | 52 |
| OLLA COOL • LINE..... | 52 |
| OLLA ELÉCTRICA..... | 314 |
| OLLA INOX-PRO..... | 48, 44 |
| PAELLERA ACERO ESMALTADO | 84 |
| PAELLERA ALUMINIO | 73 |
| PAELLERA INOX-PRO..... | 48 |
| PAELLERA VALENCIANA..... | 84 |
| PAELLERO ESMALTADO GAS..... | 85 |

español

| ARTÍCULO | PÁGINA |
|--|--|
| PALA..... | 28, 95, 99, 111, 113-114, 144, 342, 442, 444, 465, 497 |
| PALA CHIPS..... | 111 |
| PALA FAST-FOOD | 113 |
| PALA HIELO | 497 |
| PALA MEDIDORA..... | 144 |
| PALA PASTELES..... | 114, 442, 444 |
| PALA PESCADO..... | 99, 113 |
| PALA PIZZA | 95 |
| PALA PRESENTACIÓN..... | 342, 465 |
| PANEL INFORMACIÓN | 450 |
| PAÑO SILICONA..... | 149 |
| PAPELERA SOBREMESA | 483 |
| PARRILLA PLANA CON ASAS ALUMINIO | 79 |
| PASAPURÉS..... | 118 |
| PERFILES DIVISORIOS..... | 192, 195 |
| PIE CON PORTACUBOS..... | 493 |
| PINCEL | 159 |
| PINCHANOTAS..... | 482 |
| PINCHO / BROCHETA..... | 28, 482 |
| PINCHOS. SOPORTE PRESENTACIÓN. CUBIC | 418 |
| PINZA..... | 35, 95, 107-110, 168, 446, 447-449, 469, 497 |
| PINZA BUFFET | 108-109, 447 |
| PINZA CHARCUTERÍA..... | 449 |
| PINZA PARA MARISCO | 449 |
| PINZA REPOSTERÍA | 448 |
| PINZA SERVICIO | 447 |
| PINZAS PARA EMPLATAR..... | 107 |
| PIZARRAS..... | 451 |
| PIZARRAS PRESENTACIÓN | 466-467 |
| PLACA "RESERVADO"..... | 481 |
| PLACA ADAPTADORA ANGULAR | 329 |
| PLACA CALIENTE | 318 |
| PLACA ENFRIADORA..... | 433 |
| PLACA PROHIBIDO FUMAR..... | 481 |
| PLACAS INDUCCIÓN..... | 284-293 |
| PLANTILLAS | 41, 410-411 |
| PLATOS..... | 221, 334-336, 338, 344-350, 353-357, 360-361, 368, 370 |
| PLATOS COLORES..... | 336, 357 |
| PORCIONADOR APRETABLE | 104 |
| PORTA CUBIERTOS | 223, 237, 257, 420, 427 |
| PORTA PINCHOS..... | 35, 482 |
| PORTAMENÚS..... | 484 |
| PORTASALADOS / PORTASALSAS..... | 344, 352, 360, 380, 382, 479 |
| PORTATARJETAS | 484 |
| POSTE SEPARACIÓN..... | 450 |
| PRESENTADOR BOLS MELAMINA. CUBIC..... | 421 |
| PRESENTADOR CUBETAS GN | 198, 379 |
| PROCESADOR DE ALIMENTOS..... | 302-303 |
| PROCESADOR VERSÁTIL MANUAL | 137 |
| PROCESADORES MANUALES DE ALIMENTOS..... | 129-139 |
| PROTECTOR ACRÍLICO ANTI-ALIENTO..... | 394 |
| PROTECTOR ANTI-ALIENTO | 394 |
| PUJADAS 1921. HIERRO DE FUNDICIÓN ULTRALIGERO INDUCCIÓN..... | 81 |
| QUEMADOR ELÉCTRICO..... | 160 |
| RACIONADOR DE HELADO | 152 |
| RALLADOR..... | 120-121 |
| RASQUETA..... | 113-114 |
| REBANADORA DE FRUTAS Y VERDURAS..... | 133 |

español

| ARTÍCULO | PÁGINA |
|--|-----------------------------------|
| RECIPIENTE PARA SALSAS | 145, 337, 380, 463, 477, 479, 480 |
| RECOGEMIGAS | 483 |
| RECOGEVERDURAS..... | 140 |
| REJILLAS GN..... | 92 |
| REJILLAS PASTELERÍA..... | 88 |
| RELOJ DE COCINA DIGITAL..... | 147 |
| REMO..... | 124 |
| RETERMALIZADOR | 306-313 |
| RETERMALIZADOR RETRO | 308-309 |
| RETERMALIZADORES / CALENTADORES ALIMENTOS..... | 310-314 |
| RODILLO | 158-159 |
| RULETA CORTAPIZZAS | 113 |
| RUSTIDERA | 88 |
| SACACORCHOS..... | 500, 502 |
| SACACORCHOS DE PARED..... | 502 |
| SALSERA | 479 |
| SALSERA BORDE ONDULADO..... | 479 |
| SARTÉN "LIONESA" | 83 |
| SARTÉN ACERO INOXIDABLE..... | 70-72 |
| SARTÉN ALUMINIO | 73-76 |
| SARTÉN ALUMINIO FUNDICIÓN | 78-80 |
| SARTÉN BLACK PRO..... | 78 |
| SARTÉN CRÊPES..... | 79, 80 |
| SARTÉN HONDA ESMALTADA CON ASAS..... | 84 |
| SARTÉN IDEA..... | 72 |
| SARTÉN MULTIMETAL | 69 |
| SARTÉN PARA BLINIS..... | 76 |
| SARTÉN STEEL PRO..... | 81 |
| SARTENES | 62-83, 408 |
| SARTENES COOL • LINE..... | 71 |
| SAUTEX ALUMINIO | 59 |
| SAUTEX INOX-PRO | 50 |
| SERVILLETERO..... | 419, 483, 515 |
| SERVILLETERO. CUBIC..... | 419 |
| SOLUCIONES DE DISPENSADO..... | 510-515 |
| SOPERA | 439 |
| SOPLETE COCINA..... | 160 |
| SOPORTE MÁRMOL EXHIBICIÓN..... | 373 |
| SOPORTE PARA BANDEJAS DE GRAN TAMAÑO..... | 482 |
| SOPORTE PARA CHINO O EMBUDO..... | 116 |
| SOPORTE PARA CUBO CHAMPÁN..... | 495 |
| SOPORTE PARA MANGAS PASTELERAS..... | 170 |
| SOPORTE PARA NÚMEROS..... | 481 |
| SOPORTE PARA PINCHOS. CUBIC..... | 419 |
| SOPORTE PARA TABLAS DE CORTE..... | 202 |
| SOPORTE PRESENTACIÓN MADERA BLANCA..... | 371 |
| SOPORTE PRESENTACIÓN PIZARRA-MÁRMOL..... | 373 |
| SOPORTE TAPAS GN..... | 202 |
| SPOODLE® | 102-103, 105 |
| STONE..... | 354 |
| SUPER PAN® 3 | 201 |
| SUPER PAN® SUPER SHAPES | 200-201 |
| TABLA DE CORTE..... | 140-142 |
| TABLA DE CORTE VIOLET..... | 142 |
| TABLA PRESENTACIÓN | 342 |
| TABLAS DE MADERA..... | 462 |
| TAPA BATERIA..... | 33, 49, 399 |
| TAPA GN | 33, 197, 203, 205, 207-208 |

Index

Índice

Index

| ARTÍCULO | PÁGINA |
|----------------------------------|------------------------|
| TAPA GRILLBOX..... | 28 |
| TAPA HERMÉTICA GN..... | 33, 197 |
| TAPA HERMÉTICA GN EASY OPEN..... | 197 |
| TAPA INOX PARA PLATOS..... | 485 |
| TAPA INOX-PRO..... | 49 |
| TAPA PARA CESTA..... | 236 |
| TAPA PLATOS | 485 |
| TAPA PLATOS PLÁSTICO | 485 |
| TAPA POLINORM® | 197, 203, 205, 207 |
| TAPA TAZA DESAYUNO..... | 221 |
| TAPAS GN TRANSPARENTES..... | 341, 397 |
| TAPAS PARA PLATOS..... | 485 |
| TAPETE DE SILICONA..... | 95 |
| TAPÓN CHAMPÁN | 500 |
| TAPÓN UNIVERSAL | 500 |
| TAZA..... | 221, 369 |
| TAZA MEDIDORA..... | 145, 146 |
| TENEDOR..... | 101, 103, 441-443, 446 |
| TERMO CON DOSIFICADOR..... | 506 |
| TERMÓMETRO | 147-148 |
| TERRACOTA..... | 352-353 |
| TETERA..... | 503, 504-505 |
| TETERA CON FILTRO..... | 504 |
| TOSTADORA | 296-300 |
| TRIBUTE..... | 45, 69 |
| TRÍPODE PAELLERO..... | 85 |
| T-VERSION | 228-233 |
| UTENSILIOS DE SERVICIO | 440-449 |
| VAPORERA INOX-PRO | 52 |
| VASO | 221, 356, 457, 496 |
| VERSATIL MACHINE | 135 |
| VIOLET COLLECTION | 208 |
| VITRINAS DE VIDREO | 321 |
| VITRINAS PRESENTACIÓN | 402 |
| WOK ACERO | 83 |
| WOK BLACK SERIES..... | 79 |
| WOK INOX..... | 72 |
| WOK MULTIMETAL | 77 |
| WOK STEEL PRO | 81 |

Index

Índice

Index

| ARTICLE | PAGE |
|--|---|
| ANTIMICROBIEN..... | 102, 103 |
| APLATISSEUR..... | 119 |
| APPAREILS ET DE MAINTIEN EN TEMP. | 313, 314 |
| APPAREILS MANUELS DE TRANSFORMATION DES ALIMENTS . | 129-139 |
| ARAIGNÉE | 100 |
| ARDOISES PRÉSENTATION..... | 466-467 |
| ARMOIRE CHAUD..... | 321 |
| ASSIETTES | 221, 334-336, 338, 344-350, 353-357, 360-361, 368, 370 |
| ASSIETTES, COULEUR | 336, 357 |
| BAC À ALIMENTS .. | 155, 201, 318, 345, 349-350, 355, 365, 370, 409, 429, 438, 461 |
| BAC GASTRONORME SANS BPA..... | 204, 205 |
| BAC GN ACIER ÉMAILLÉ | 400 |
| BAIN-MARIE | 50, 313, 318, 433 |
| BALANCE | 147 |
| BAMBOU NATUREL & BOIS | 468, 469 |
| BANDE À SILICONE | 198 |
| BAR KEEP®..... | 498 |
| BARRE INTERMÉDIAIRE..... | 192, 195 |
| BARRE PORTE-BONS | 124 |
| BASSINE..... | 154 |
| BASSINE PÂTISSIÈRE | 155 |
| BATTERIE À COULEURS..... | 55 |
| BATTERIE BRONZE | 399 |
| BATTERIE DE CUISINE / PRÉSENTATION | 408-411 |
| BLACK FIRST | 80 |
| BLACK PRO | 78-79 |
| BLACK SERIES | 60 |
| BOIS BLANVC, PLATEAU | 371 |
| BOÎTE À CONDIMENT..... | 499 |
| BOÎTE EN BOIS | 387 |
| BOÎTE PPE | 213 |
| BOL.. | 221, 334, 337-339, 344-346, 348, 353-354, 356, 359-360, 362-363, 365-370, 380, 395, 437 |
| BOL POUR SNACKS..... | 344, 352, 360, 380, 382, 479 |
| BOLS DE SERVICE ISOTHERMES À DOUBLE PAROI..... | 221, 437 |
| BOLS NID D'ABEILLES À PAROI INCLINÉE | 437 |
| BOUCHON À CHAMPAGNE..... | 500 |
| BOUCHON UNIVERSEL | 500 |
| BOUEILLE DE BAR | 498, 500 |
| BRAISE | 27-37 |
| BROCHETTE..... | 28, 482 |
| BROSSE METALLIQUE | 124 |
| BRÛLER ÉMAILLÉ..... | 85 |
| BUFFET CUBIC. CHARIOT BUFFET..... | 425-427 |
| BUFFET CUBIC. CUBES ET TABLETTES | 421 |
| BUFFET CUBIC. MEUBLE PRÉSENTOIR | 419, 422, 423 |
| CADDY DE TABLE | 480 |
| CAFETIÈRE | 502-505 |
| CANNETTE ISOLANTE | 507 |
| CARAMÉLISER | 160 |
| CASSE-NOIX..... | 449 |
| CASSE-PATTES..... | 449 |
| CASSEROLE ALUMINIUM..... | 59 |
| CASSEROLE BOMBÉE | 46, 50, 59 |
| CASSEROLE COOL • LINE | 55 |
| CASSEROLE FORME FRANÇAISE..... | 49 |
| CASSEROLE INOX-PRO..... | 49-50 |

français

| ARTICLE | PAGE |
|--|----------------------------|
| CASSEROLÉS DOSEUR..... | 145 |
| CAYENNE®..... | 312-313 |
| CAYENNE® RÉCHAUDS ET APPAREILS DE REMISE EN TEMPÉRATURE .. | 310-314 |
| CENDRIER | 383, 483 |
| CENTURY..... | 58, 59 |
| CERCLE | 167 |
| CHAFERS | 428-431 |
| CHAFERS INTRIGUE | 429 |
| CHAFERS, ACCESSOIRES POUR | 429, 432, 434 |
| CHAFING DISH ECONOMIQUE..... | 431 |
| CHARIOT À CHARGES LOURDES..... | 259 |
| CHARIOT À DÉGIVRAGE | 254 |
| CHARIOT À GLISSIÈRES | 250-257 |
| CHARIOT À GLISSIÈRES, DÉMONTABLE..... | 251-253 |
| CHARIOT À GLISSIÈRES, EMBOÎTABLE..... | 251, 252 |
| CHARIOT À PLASTIQUE | 244, 245, 260, 261 |
| CHARIOT AJUSTABLE | 261 |
| CHARIOT AVEC PLAN DE TREBALL..... | 258 |
| CHARIOT DE DÉBARASSAGE..... | 245, 246 |
| CHARIOT DE SERVICE DÉMONTABLE | 248 |
| CHARIOT DE SERVICE EN ALUMINIUM..... | 245 |
| CHARIOT DOUBLE POUR PLATEAUX FAST-FOOD..... | 256 |
| CHARIOT EN BOIS | 425-427 |
| CHARIOT GUERIDON..... | 426 |
| CHARIOT POUR PANIERS À VAISSELLE | 259-260 |
| CHARIOT TRANSPORT BAC GN | 250-252, 258 |
| CHARIOTS DE SERVICE INOXYDABLE..... | 246-249, 255 |
| CHARIOTS SPÉCIAUX | 257-261 |
| CHEMINÉE..... | 28 |
| CHINOIS À GAZE..... | 116 |
| CLIP D'IDENTIFICATION..... | 228, 234, 235, 239, 240 |
| COCKTAIL | 496, 497 |
| COCOTTE | 60 |
| COCOTTE BLACK SERIES..... | 60 |
| COCOTTES FONTE ALUMINIUM | 459 |
| COLLECTIVITÉS..... | 220-223 |
| CONTENEUR POUR SERVIETTES..... | 419, 483, 515 |
| COOL • LINE..... | 55, 71 |
| CORBEILLE PAIN | 473-477 |
| CORBEILLES POLYPROPYLENE..... | 474-477 |
| CORPS DE CHAUFFE POUR CHAFING DISH..... | 432 |
| COUPE À GLACE | 153 |
| COUPE EN CUBES | 135 |
| COUPE FRITES..... | 131 |
| COUPE TOMATES | 137 |
| COUPE-OEUF..... | 138 |
| COUPE-ONIONS | 133 |
| COUPE-SALADE | 132 |
| COUP-FRUIT ET LÉGUMES..... | 133 |
| COUSCOUSSIER..... | 51 |
| COUTEAU | 441, 443, 446 |
| COUTEAU / ROULEAU (PIÈCE DE RECHNGE)..... | 138 |
| COUTEAU À BEURRE | 114 |
| COUVER-ASSIETTES EN PLASTIQUE | 485 |
| COUVERCLE BATTERIE | 33, 49, 399 |
| COUVERCLE GN..... | 33, 197, 203, 205, 207-208 |
| COUVERCLE GRILLBOX | 28 |

français

| ARTICLE | PAGE |
|---|---|
| COUVERCLE HERMET | 33, 197 |
| COUVERCLE HERMET EASY OPEN..... | 197 |
| COUVERCLE INOX-PRO | 49 |
| COUVERCLE POLINORM®..... | 197, 203, 205, 207 |
| COUVERCLE POUR COUPELLE DESSERT..... | 221 |
| COUVERCLE POUR PANIER | 236 |
| COUVERCLES À ASSIETTE | 485 |
| COUVERCLES À ASSIETTE | 485 |
| COUVERCLES GN TRANSPARENTS | 341, 397 |
| COUVRE-ASSIETTES INOX..... | 485 |
| CREMIÈRE..... | 502-504 |
| CRÉPIÈRE..... | 294 |
| CROCHET | 118 |
| CUILLÈRE..... | 100, 101, 103-105, 157, 369, 380, 441-446 |
| CUILLÈRE À COCKTAIL..... | 497 |
| CUILLÈRE À GLACE | 152 |
| CUILLÈRES À MESURER | 144, 145 |
| CUILLÈRES À SERVIR | 441-443, 444-446 |
| CUISEUR À RIZ..... | 294 |
| CUIT-PÂTES..... | 52 |
| CUIT-VAPEUR INOX-PRO..... | 52 |
| DEMI-SPÉRIQUE..... | 155 |
| DISTRIBUER À JUS | 435 |
| DISTRIBUTEUR À LAIT..... | 434, 435 |
| DISTRIBUTEUR À PRESSION..... | 122, 123 |
| DISTRIBUTEUR CONTRÔLE DE LA PARTIE | 162 |
| DISTRIBUTEUR DE CÉRÉALES | 435 |
| DISTRIBUTEUR DES SAQUETTES THÉ & SUCRE. CUBIC | 419 |
| DISTRIBUTEUR ET HOUSSES JETABLES | 250 |
| DISTRIBUTEUR SERVIETTES. CUBIC | 419 |
| DISTRIBUTEURS..... | 162, 434, 435 |
| DIVISEUR | 134 |
| DOSEUR À PRESSER..... | 104 |
| DOUILLE | 171-174 |
| ECAILEUR | 124 |
| ECUMOIRE | 99, 100, 441-444 |
| EGOUTTOIRS POUR BACS GASTRONORME..... | 195, 196, 203, 205, 254 |
| ELEGANCE..... | 355 |
| ENCASTRÉE..... | 289, 293 |
| ENTONNOIR..... | 118, 162 |
| ENTONNOIR DOSEUR..... | 162 |
| EPINGLE PORTE-TICKETS..... | 482 |
| ETAGÈRES | 268-277 |
| FAITOUT ALUMINIUM | 58 |
| FAITOUT COOL • LINE..... | 55 |
| FAITOUT INOX-PRO | 48 |
| FLAP IDENTIFICATION | 227 |
| FLAP-RACK® | 227, 228 |
| FONTAIN À CHOCOLAT..... | 318 |
| FOUET..... | 156 |
| FOUR À BRAISE | 29-31 |
| FOUR À MICRO-ONDES..... | 294 |
| FOURCHETTE | 101, 103, 441-443, 446 |
| FOURS..... | 29-31, 294 |
| FRITEUSE | 295 |
| FUEL POR CHAFING DISH..... | 432 |
| GABARITS..... | 41, 410-411 |
| GANT À FOUR..... | 149 |

Index

Índice

Index

| ARTICLE | PAGE |
|---|-------------------|
| GANTS..... | 149 |
| GARTRONORME POUR CHARIOT DÉGIVRAGE | 254 |
| GASTRONORM INOXYDABLE | 194-197 |
| GASTRONORME (MELAMINE) | 374-378 |
| GASTRONORME (POLYCARBONATE)..... | 202-203 |
| GASTRONORME (POLYPROPYLENE)..... | 206-207 |
| GASTRONORME AVEC FOND THERMO-DIFFUSEUR | 189, 199, 401 |
| GASTRONORME VIOLET | 208 |
| GEL LUBRIFIANT SANITAIRE..... | 139, 303 |
| GLACES..... | 150-151, 322-327 |
| GN PASTRY PAN | 154 |
| GOUTIÈRE | 169 |
| GRILL..... | 79, 80 |
| GRILL DE CONTACT | 301 |
| GRILL PLAT AVEC POIGNÉES..... | 79 |
| GRILLE GN..... | 92 |
| GRILLE PÂTISSERIE | 88 |
| HUILIÈRE | 124 |
| INOX-PRO..... | 46-53 |
| KITS PRÉPARÉS DE ÉTEGÈRE..... | 268-277 |
| KITS. CUBIC..... | 415-417 |
| LAMPE CHAUFFANTE | 315-317 |
| LIDSAVER®..... | 510-515 |
| LOUCHE..... | 98, 369, 441-445 |
| MANDOLINES | 139 |
| MARMITE ALUMINIUM..... | 56-59 |
| MARMITE BUFFET..... | 314 |
| MARMITE COOL • LINE..... | 52 |
| MARMITE INOX-PRO..... | 48, 44 |
| MARMITE TRAITÉUR AVEC ROBINET | 52 |
| MARMITES DE REMISE EN TEMPÉRATURE | 306-313 |
| MARMITES DE REMISE EN TEMPÉRATURE RÉTRO..... | 308-309 |
| MARQUEURS..... | 451 |
| MEDITERRANEAN..... | 356 |
| MELAMINE POUR PRÉSENTATION | 334-383 |
| MÉLAMINE SLIM..... | 376-377 |
| MÉLANGEURS | 302, 303 |
| MÉLANGEURS DE COMPTOIR..... | 302 |
| MESURE À COCKTAIL..... | 497 |
| MINIATURE FONTE ÉMAILLÉE | 460-461 |
| MINIATURES ACIER ÉMAILLÉ | 458 |
| MINIATURES ACIER INOXYDABLE | 454-456 |
| MINIATURES MÉLAMINE | 380-382 |
| MINUTEUR DE CUISINE..... | 147 |
| MIRAGE®..... | 292-293, 306-309 |
| MIRAGE® 3D INDUCTION | 306-307 |
| MIRAGE® INDUCTION WARMER | 293 |
| MIRAMAR® | 408-411 |
| MIRAMAR® BATTERIE DE CUISINE / PRÉSENTATION | 406-409 |
| MOULE À CAKE | 163-165, 169, 182 |
| MOULE À FLAN | 169 |
| MOULE À FLAN ÉVASSÉ | 479 |
| MOULE À NID..... | 100 |
| MOULE À OEUF..... | 119 |
| MOULE À PIZZA | 93 |
| MOULE COEUR | 168 |
| MOULE HEXAGONE..... | 168 |
| MOULE LARME | 168 |

| ARTICLE | PAGE |
|---|--|
| MOULE OVALE..... | 165, 168 |
| MOULES "FLEXIPAN"..... | 175-181 |
| MOULES À SILICONE 600 X 400..... | 184-185 |
| MOULES DE SILICONE..... | 182-185 |
| MOULES PÂTISSERIE..... | 163-165, 167-169, 177-189 |
| MOULIN À LÉGUMES..... | 118 |
| MOULINS À POIVRE..... | 481 |
| MOULINS À SEL..... | 481 |
| MULTIMÉTAL..... | 50, 77 |
| NUMÉRO DE TABLE..... | 481 |
| OICHET À EAU..... | 508-509 |
| OUVRE-BOÎTES..... | 138 |
| PALETTE..... | 99, 112, 113, 157, 441-446 |
| PALETTE À FISH..... | 99, 113 |
| PALETTE FAST-FOOD..... | 113 |
| PANIER EN MÉTAL..... | 471 |
| PANIER FERMÉES..... | 230-233 |
| PANIER OUVERTS..... | 234, 235 |
| PANIER POUR ASSITTES..... | 238-240 |
| PANIER POUR COUVERTS..... | 236, 237, 477 |
| PANIER POUR PLATEAUX..... | 240 |
| PANIER POUR PLATEAUX ISOTHERMES..... | 240 |
| PANIER UNIVERSEL..... | 236 |
| PANIER, MÉTALIQUE..... | 390 |
| PANNEAU INFORMATION..... | 450 |
| PARE-HALEINE MOBILES..... | 394 |
| PARE-HALEINE MOBILES EN ACRYLIQUE..... | 394 |
| PASSOIRE À COCKTAIL..... | 497 |
| PASSOIRE À POIGNÉES..... | 117 |
| PASSOIRE À QUEUE..... | 115-116 |
| PELLE..... | 28, 95, 99, 111, 113-114, 144, 342, 442, 444, 465, 497 |
| PELLE À ENFOURNER..... | 95 |
| PELLE À FARINE..... | 152, 155, 497 |
| PELLE À FRITES..... | 111 |
| PELLE À GÂTEAU..... | 114, 442, 444 |
| PELLE À LÉGUMES..... | 140 |
| PELLE GLAÇON..... | 497 |
| PELLE MESURE..... | 144 |
| PELLE PRÉSENTATION..... | 342, 465 |
| PETIT PANIER POUR LES COUVERTS..... | 237 |
| PICHET..... | 507 |
| PICHET GRADUÉ..... | 146 |
| PICHET POLYCARBONATE..... | 509 |
| PIED PORTE-SEAU..... | 493 |
| PIED POUR BRÛLEUR..... | 85 |
| PINCE..... | 35, 95, 107-110, 168, 446, 447-449, 469, 497 |
| PINCE À GÂTEAU..... | 448 |
| PINCE À VIANDE..... | 449 |
| PINCE BUFFET..... | 108-109, 447 |
| PINCE DE SERVICE..... | 447 |
| PINCEAU..... | 159 |
| PINCES POUR PRÉSENTATION..... | 107 |
| PIQUES SUPPORT PRÉSENTATION. CUBIC..... | 418 |
| PLANCHE À DÉCOUPER..... | 140-142 |
| PLANCHE À DÉCOUPER VIOLET..... | 142 |
| PLAQUE "DÉFENSE DE FUMER"..... | 481 |
| PLAQUE "RÉSERVÉ"..... | 481 |
| PLAQUE À PÂTISSERIE..... | 90-92, 351 |

| ARTICLE | PAGE |
|--|---|
| PLAQUE À PIZZA..... | 93, 94 |
| PLAQUE À RÔTIR..... | 88 |
| PLAQUE ALUMINIUM ANTI-ADHESIF..... | 89, 91 |
| PLAQUE CHAUFFANTE..... | 318 |
| PLAQUE GASTRONORME..... | 89, 367, 465 |
| PLAQUE INTERMÉDIAIRE INCLINÉE..... | 329 |
| PLAQUE RÉFRIGÉRANTE..... | 433 |
| PLAQUES À PIZZA..... | 93 |
| PLAQUES INDUCTION..... | 284-293 |
| PLAT À PAELLA ACIER ÉMAILLÉ..... | 84 |
| PLAT À PAELLA ALUMINIUM..... | 73 |
| PLAT À PAELLA EN TÔLE ACIER..... | 84 |
| PLAT À PAELLA INOX-PRO..... | 48 |
| PLAT OVALE..... | 345, 349-350, 355, 365, 370, 438, 461 |
| PLATEAU..... | 89-92, 220, 222-223, 335, 340-341, 343-344, 350-355, 360, 362, 364-367, 371-372, 380, 382 |
| PLATEAU DE PRÉSENTATION..... | 342 |
| PLATEAU DE SERVICE..... | 388, 389, 501 |
| PLATEAU DE SERVICE ANTI-DÉRRAPANT..... | 482, 501 |
| PLATEAU FAST-FOOD..... | 222 |
| PLATEAU FORME OVALE..... | 482 |
| PLATEAU ISOTHERMIC..... | 256 |
| PLATEAU MARBRES NOIR..... | 373 |
| PLATEAU PRÉSENTATION..... | 335, 340, 341, 345, 351, 371, 380, 395, 420, 467 |
| PLATEAU PRÉSENTATION. CUBIC..... | 416-418, 420 |
| PLATEAU SELF-SERVICE ACIER INOX..... | 222 |
| PLATEAUX EN FIBRE DE VERRE..... | 222 |
| PLATEAUX INOX PRÉSENTATION..... | 464-465 |
| POCHES PÂTISSIÈRES..... | 170 |
| POËLE "LYONNAISE"..... | 83 |
| POËLE À BLINIS..... | 76 |
| POËLE À CRÊPES..... | 79, 80 |
| POËLE ACIER INOXYDABLE..... | 70-72 |
| POËLE ALUMINIUM..... | 73-76 |
| POËLE ALUMINIUM FONTÉ..... | 78-80 |
| POËLE BLACK SERIES..... | 78 |
| POËLE COOL • LINE..... | 71 |
| POËLE HAUTE AVEC ANSES..... | 84 |
| POËLE IDEA..... | 72 |
| POËLE MULTIMÉTAL..... | 69 |
| POËLE PUJADAS 1921..... | 81 |
| POËLES..... | 62-83, 408 |
| POLUCARBONATE DOUILLE..... | 174 |
| PORTE-BROCHETTES..... | 35, 482 |
| PORTE-CARTES..... | 484 |
| PORTE-MENU..... | 484 |
| POT À INFUSIONS..... | 505 |
| POT MESUREUR..... | 146 |
| POTEAU..... | 450 |
| PRÉSENTOIR..... | 386, 391-393 |
| PRÉSENTOIR 3 NIVEAUX. CUBIC..... | 417 |
| PRÉSENTOIR BACS GASTRONORME..... | 198, 223, 379, 417 |
| PRÉSENTOIR BOLS MÉLAMINE. CUBIC..... | 421 |
| PRÉSENTOIR BUFFET..... | 339, 340, 395 |
| PRÉSENTOIR DE TARTES..... | 161 |
| PRÉSENTOIR GN BAMBOU..... | 391 |
| PRÉSENTOIR GRANITE-ARDOISE..... | 373 |

| ARTICLE | PAGE |
|---|-----------------------------------|
| PRESSE CITRON..... | 497 |
| PROCESSEUR VERSATILE ET MANUEL..... | 137 |
| PROTECTRICE EN VINYLE..... | 261 |
| PUJADAS 1921. FONTE ULTRALÉGER INDUCTION..... | 81 |
| RACLETTE..... | 113-114 |
| RAMASSE-COUVERTS..... | 223 |
| RAMASSE-COUVERTS POUR CHARIOT SERVICE..... | 246 |
| RAMASSE-MIETTES..... | 483 |
| RAMEQUIN..... | 145, 337, 380, 463, 477, 479, 480 |
| RÂPE..... | 120-121 |
| RECEPTALBE À DÉCHETS..... | 483 |
| RÉCHAUD..... | 257, 321 |
| RÉCIPIENT À GLACE..... | 153 |
| RECTANGLE POUR PLAQUES INOX..... | 90 |
| REFRAÎCHISSEUR..... | 495 |
| REFRAÎCHISSEUR BOUTEILLES. CUBIC..... | 418 |
| REFRAÎCHISSEUR ISOTHERME..... | 493 |
| ROBOT MULTIFUNCTION..... | 302-303 |
| ROULEAU..... | 158-159 |
| ROULETTE À PÂTES..... | 158, 166-168 |
| ROULETTE À PIZZA..... | 113 |
| RUBAN PÂTISSIER..... | 168 |
| SACS À DOS DE LIVRAISON..... | 218-219 |
| SACS À PIZZAS..... | 214, 215 |
| SACS DE TRAITEUR..... | 216, 217 |
| SALADIER..... | 439 |
| SAUCIÈRE..... | 479 |
| SAUPOUDREUSES..... | 123 |
| SAUTEUSE ALUMINIUM..... | 59 |
| SAUTEUSE INOX-PRO..... | 50 |
| SEAU À CHAMPAGNE..... | 491, 492, 494, 495 |
| SEAU À CHAMPAGNE EN PLASTIQUE..... | 494-495 |
| SEAU À CHAMPAGNE, COMPLÉMENTS..... | 500 |
| SEAU À GLAÇONS..... | 493 |
| SEAU AVEC BASE..... | 146 |
| SEAUX À VIN..... | 491, 492, 494, 495 |
| SÉPARATEUR DE PORTIONS..... | 160 |
| SETS DE TABLE..... | 478 |
| SHAKER..... | 496 |
| SOLUTIONS DE DISTRIBUTION..... | 510-515 |
| SOUPIÈRE..... | 439 |
| SPATULE GÉANTE..... | 124 |
| SPOODLE®..... | 102-103, 105 |
| STATIONS POUR BUFFET..... | 317 |
| STONE..... | 354 |
| STOP GOUTTES..... | 500 |
| SUCRIER..... | 503 |
| SUPER PAN® 3..... | 201 |
| SUPER PAN® SUPER SHAPES..... | 200-201 |
| SUPPORT À PIQUES. CUBIC..... | 419 |
| SUPPORT DE TABLE POU SEAUX..... | 495 |
| SUPPORT NUMÉRO..... | 481 |
| SUPPORT POUR BACS GN..... | 258, 427 |
| SUPPORT POUR BACS GN..... | 198, 379 |
| SUPPORT POUR COUVERCLES GN..... | 202 |
| SUPPORT POUR ENTONNOIR OU CHINOIS..... | 116 |
| SUPPORT POUR GRANDS PLATEAUX..... | 482 |
| SUPPORT POUR PLANCHES À DÉCOUPER..... | 202 |

| ARTICLE | PAGE |
|-----------------------------------|-------------------------|
| SUPPORT POUR POCHE PÂTISSIER..... | 170 |
| SUPPORT RAMASSE-COUVERTS..... | 223, 237, 257, 420, 427 |
| TABLE À DÉCOUPER..... | 140-142 |
| TABLE EN BOIS..... | 462 |
| TABLEAUX..... | 451 |
| TAMIS..... | 161 |
| TAPIS..... | 149 |
| TAPIS ANTIDÉRAPANT..... | 501 |
| TAPIS DE BAR..... | 498 |
| TASSE..... | 221, 369 |
| TASSE GRADUÉE..... | 145, 146 |
| TCHARIOT BOISSON..... | 489, 490 |
| TERRACOTA..... | 352-353 |
| THÉIÈRE..... | 503, 504-505 |
| THÉIÈRE AVEC FILTRE..... | 504 |
| THERMOMÈTRE..... | 147-148 |
| TIRE-BOUCHONS..... | 500, 502 |
| TIRE-BOUCHONS MUR..... | 502 |
| TOASTEUR..... | 296-300 |
| TOILE DE CUISSON..... | 95 |
| TORCHE À CARAMÉLISER..... | 160 |
| TORCHON EN SILICONE..... | 149 |
| TRANCHES ET CUBES..... | 129, 130 |
| TRANCHEUR ELÉCTRIQUE..... | 303 |
| TRIBUTE..... | 45, 69 |
| TURBINE À GLACE..... | 326 |
| T-VERSION..... | 228-233 |
| USTENSILS DE SERVICE..... | 440-449 |
| VERRE..... | 221, 356, 457, 496 |
| VERSATIL MACHINE..... | 135 |
| VERSEUSE À POMPE..... | 506 |
| VIDE / COUPE POMMES..... | 138 |
| VIOLET COLLECTION..... | 208 |
| VITRINES À PÂTISSERIES..... | 396, 397 |
| VITRINES EN VERRE..... | 321 |
| VITRINES PRÉSENTATION..... | 402 |
| WOK ACIER..... | 83 |
| WOK BLACK SERIES..... | 79 |
| WOK INOX..... | 72 |
| WOK MULTIMÉTAL..... | 77 |
| WOK STEEL PRO..... | 81 |

Numerical index

Índice numérico
Index numérique

| REF. | PAG. | REF. | PAG. | REF. | PAG. | REF. | PAG. | REF. | PAG. |
|-----------|------|----------|------|---------|------|---------|------|---------|------|
| 0644N | 137 | 19196 | 392 | 40770 | 303 | 46656 | 145 | 47157 | 152 |
| 0654 | 137 | 2208-13 | 122 | 40771 | 303 | 46657 | 145 | 47158 | 152 |
| 1009-01 | 228 | 2212-13 | 122 | 40772 | 303 | 46658 | 145 | 47159 | 152 |
| 1009-02 | 228 | 2224-13 | 122 | 40773 | 303 | 46659 | 145 | 47160 | 152 |
| 1009-03 | 228 | 2331-99 | 498 | 40774 | 303 | 46661 | 145 | 47161 | 152 |
| 1009-04 | 228 | 26120-13 | 123 | 40775 | 303 | 46665 | 437 | 47169 | 152 |
| 1009-05 | 228 | 26240-13 | 123 | 40776 | 303 | 46666 | 437 | 47170 | 152 |
| 1009-06 | 228 | 26320-13 | 123 | 40862 | 321 | 46667 | 437 | 47171 | 152 |
| 1009-08 | 228 | 2803-18 | 162 | 40863 | 321 | 46671 | 317 | 47172 | 152 |
| 1009-19 | 228 | 2808-13 | 122 | 434 | 132 | 46672 | 317 | 47200 | 152 |
| 1009-32 | 228 | 2812-13 | 122 | 435 | 132 | 46787 | 497 | 47274 | 152 |
| 1078-13 | 485 | 2908-13 | 123 | 4400N | 132 | 46789 | 500 | 47275 | 152 |
| 1100-13 | 485 | 2912-13 | 123 | 4408 | 132 | 46790 | 497 | 47276 | 152 |
| 1200-13 | 485 | 306 | 134 | 44572 | 144 | 46791 | 496 | 47277 | 152 |
| 1400 | 139 | 308 | 134 | 45603-1 | 131 | 46793 | 496 | 47278 | 152 |
| 1420-01 | 501 | 3100020 | 404 | 45749-1 | 131 | 46861 | 429 | 47279 | 152 |
| 1474-0606 | 501 | 3100040 | 404 | 45750-1 | 131 | 4689760 | 105 | 47309 | 108 |
| 1476-0606 | 501 | 3100220 | 404 | 45751-1 | 131 | 4689815 | 105 | 47312 | 108 |
| 15000 | 130 | 3100240 | 404 | 46009 | 393 | 4689830 | 105 | 47316 | 108 |
| 15001 | 130 | 3100320 | 404 | 4600960 | 393 | 4689840 | 105 | 47322 | 110 |
| 15002 | 130 | 3100321 | 404 | 46070 | 431 | 4689850 | 105 | 47325 | 111 |
| 15005 | 130 | 3100340 | 404 | 46080 | 431 | 4689860 | 105 | 47326 | 110 |
| 15006 | 130 | 3100341 | 404 | 46093 | 434 | 4689960 | 105 | 47370 | 104 |
| 15007 | 130 | 3101015 | 403 | 46094 | 434 | 46905 | 444 | 47371 | 104 |
| 15016 | 130 | 3101020 | 403 | 46095 | 431 | 46907 | 444 | 47372 | 104 |
| 15017 | 130 | 3101040 | 403 | 46110 | 318 | 46909 | 444 | 47390 | 104 |
| 15050 | 130 | 3101120 | 403 | 46110 | 432 | 46926 | 447 | 47391 | 104 |
| 15052 | 130 | 3101220 | 403 | 46115 | 318 | 46928 | 448 | 47392 | 104 |
| 15053 | 130 | 3101240 | 403 | 46115 | 432 | 46929 | 449 | 47393 | 104 |
| 15054 | 130 | 3102015 | 403 | 46124 | 429 | 46936 | 444 | 47394 | 104 |
| 15055 | 130 | 3102020 | 403 | 46125 | 429 | 46938 | 447 | 47395 | 104 |
| 15058 | 130 | 3102040 | 403 | 46131 | 429 | 46952 | 444 | 47396 | 104 |
| 15059 | 130 | 3102120 | 404 | 46132 | 429 | 46960 | 444 | 47397 | 104 |
| 15060 | 130 | 3102220 | 403 | 46134 | 429 | 46988 | 447 | 47398 | 104 |
| 15061 | 130 | 3316-13 | 122 | 46137 | 429 | 46989 | 447 | 47399 | 104 |
| 15062 | 130 | 3324-13 | 122 | 46221 | 438 | 47002 | 156 | 47400 | 104 |
| 15063 | 130 | 3332-13 | 122 | 46285 | 434 | 47003 | 156 | 47401 | 104 |
| 15064 | 130 | 3616 | 498 | 4635110 | 434 | 47004 | 156 | 47402 | 104 |
| 15065 | 130 | 3628 | 498 | 4635210 | 435 | 47005 | 156 | 47403 | 104 |
| 15067 | 130 | 3632 | 498 | 4635810 | 434 | 47025 | 144 | 47404 | 104 |
| 15068 | 130 | 3648 | 498 | 4644010 | 428 | 47026 | 144 | 4741-06 | 499 |
| 15069 | 130 | 3664 | 498 | 4644020 | 428 | 47027 | 144 | 4743-06 | 499 |
| 15070 | 130 | 3805-06 | 513 | 46527 | 309 | 47028 | 144 | 4747 | 499 |
| 15072 | 130 | 3820-28 | 513 | 46569 | 437 | 47029 | 144 | 47488 | 307 |
| 15073 | 130 | 400N | 132 | 46582 | 437 | 47031 | 144 | 47488 | 312 |
| 15076 | 130 | 401N | 132 | 46584 | 437 | 47046 | 111 | 47490 | 307 |
| 15078 | 130 | 402NC | 132 | 46585 | 437 | 47049 | 111 | 47490 | 312 |
| 15081 | 130 | 403NH | 133 | 46586 | 437 | 47054 | 144 | 47602 | 500 |
| 15082 | 130 | 4075502 | 302 | 46587 | 437 | 47058 | 144 | 47611 | 493 |
| 15083 | 130 | 4075503 | 302 | 46588 | 144 | 47104 | 497 | 47619 | 437 |
| 15085 | 130 | 4075602 | 302 | 46589 | 145 | 47118 | 145 | 47620 | 491 |
| 15086 | 130 | 4075603 | 302 | 46590 | 437 | 47119 | 145 | 47632 | 437 |
| 15103 | 137 | 4075702 | 303 | 4659015 | 437 | 47139 | 104 | 4763215 | 437 |
| 15104 | 137 | 4075703 | 303 | 4659050 | 437 | 47140 | 104 | 4763250 | 437 |
| 15105 | 137 | 4075802 | 303 | 4659060 | 437 | 47141 | 104 | 4763260 | 437 |
| 15113 | 137 | 4075803 | 303 | 46591 | 437 | 47142 | 104 | 47634 | 437 |
| 15114 | 137 | 4075902 | 303 | 4659115 | 437 | 47143 | 104 | 4763415 | 437 |
| 15115 | 137 | 4075903 | 303 | 4659150 | 437 | 47144 | 104 | 4763450 | 437 |
| 15149 | 139 | 40761 | 302 | 4659160 | 437 | 47145 | 104 | 4763460 | 437 |
| 15209 | 137 | 40762 | 302 | 46592 | 437 | 47146 | 104 | 47635 | 437 |
| 15601 | 133 | 40763 | 302 | 4659215 | 437 | 47150 | 152 | 4763515 | 437 |
| 15604 | 133 | 40764 | 302 | 4659250 | 437 | 47151 | 152 | 4763550 | 437 |
| 1612-06 | 501 | 40765 | 303 | 4659260 | 437 | 47152 | 152 | 4763560 | 437 |
| 1697 | 260 | 40766 | 303 | 46599 | 508 | 47153 | 152 | 47637 | 437 |
| 1811 | 135 | 40767 | 303 | 46622 | 500 | 47154 | 152 | 47703 | 131 |
| 1812 | 135 | 40768 | 303 | 46654 | 145 | 47155 | 152 | 47713 | 131 |
| 1823 | 135 | 40769 | 303 | 46655 | 145 | 47156 | 152 | 47714 | 131 |

Numerical index

Índice numérico
Index numérique

| REF. | PAG. | REF. | PAG. | REF. | PAG. | REF. | PAG. | REF. | PAG. |
|---------|------|------------|------|-----------|------|---------|------|----------|------|
| 47715 | 131 | 49417 | 408 | 55477 | 129 | 6422655 | 103 | 700-4 | 134 |
| 4780610 | 110 | 49418 | 408 | 55478 | 129 | 6422865 | 103 | 702111 | 45 |
| 4780620 | 109 | 49419 | 409 | 55479 | 129 | 6432120 | 103 | 702115 | 45 |
| 4780630 | 109 | 49420 | 409 | 55480 | 129 | 6432220 | 103 | 702125 | 45 |
| 4780640 | 109 | 49423 | 409 | 55481 | 129 | 6432230 | 103 | 702135 | 45 |
| 4780650 | 109 | 49424 | 408 | 55482 | 129 | 6432335 | 103 | 702145 | 45 |
| 4780660 | 109 | 49425 | 408 | 55483 | 129 | 6432420 | 103 | 704 | 134 |
| 4780670 | 109 | 49426 | 409 | 55484 | 129 | 6432445 | 103 | 706 | 134 |
| 4780910 | 110 | 49427 | 409 | 55485 | 129 | 6433120 | 103 | 708 | 134 |
| 4780912 | 110 | 49428 | 408 | 55486 | 129 | 6433220 | 103 | 712 | 134 |
| 4780920 | 109 | 49429 | 409 | 55490 | 129 | 6433230 | 103 | 7217310 | 309 |
| 4780922 | 110 | 49430 | 408 | 55491 | 129 | 6433335 | 103 | 7217350 | 309 |
| 4780930 | 109 | 49431 | 409 | 55492 | 129 | 6433445 | 103 | 7217355 | 309 |
| 4780940 | 109 | 49432 | 409 | 55493 | 129 | 6433480 | 103 | 7217360 | 309 |
| 4780950 | 109 | 49433 | 409 | 55494 | 129 | 6433620 | 103 | 7217410 | 309 |
| 4780960 | 109 | 49435 | 409 | 595027502 | 293 | 6433655 | 103 | 7217450 | 309 |
| 4780970 | 109 | 49441 | 408 | 595027503 | 293 | 6433865 | 103 | 7217455 | 309 |
| 4780980 | 109 | 49442 | 409 | 595087502 | 293 | 64403 | 444 | 7217460 | 309 |
| 4781210 | 110 | 49445 | 409 | 595087503 | 293 | 64404 | 444 | 7217810 | 309 |
| 4781212 | 110 | 4961-1301 | 123 | 59601 | 289 | 64406 | 444 | 7217850 | 309 |
| 4781220 | 109 | 4961-1308 | 123 | 59602 | 289 | 64407 | 444 | 7217855 | 309 |
| 4781222 | 110 | 4961-13191 | 123 | 59641 | 293 | 6512-06 | 515 | 7217860 | 309 |
| 4781230 | 109 | 4961-1332 | 123 | 59642 | 293 | 6535-13 | 515 | 7217910 | 309 |
| 4781240 | 109 | 4980120 | 98 | 59650 | 289 | 6706CC | 93 | 7217950 | 309 |
| 4781250 | 109 | 4980230 | 98 | 59651 | 289 | 6706HC | 93 | 7217955 | 309 |
| 4781260 | 109 | 4980335 | 98 | 606N | 134 | 6706N | 93 | 7217960 | 309 |
| 4781270 | 109 | 4980422 | 309 | 62300 | 485 | 6708CC | 93 | 72522 | 312 |
| 4781280 | 109 | 4980445 | 98 | 62301 | 485 | 6708HC | 93 | 72550 | 313 |
| 4781610 | 110 | 4980622 | 309 | 62303 | 485 | 6708N | 93 | 72630 | 313 |
| 4781612 | 110 | 4980655 | 98 | 62305 | 485 | 6709CC | 93 | 74110210 | 307 |
| 4781620 | 109 | 4980865 | 98 | 62309 | 485 | 6709N | 93 | 74110240 | 307 |
| 4781622 | 110 | 500N | 133 | 62311 | 485 | 6710CC | 93 | 741102D | 307 |
| 4781630 | 109 | 501N | 133 | 62312 | 485 | 6710N | 93 | 74110310 | 307 |
| 4781640 | 109 | 509 | 133 | 62313 | 485 | 6712CC | 93 | 74110340 | 307 |
| 4781650 | 109 | 511 | 133 | 62314 | 485 | 6712N | 93 | 741103D | 307 |
| 4781660 | 109 | 52160 | 507 | 62315 | 485 | 671307 | 68 | 7470210 | 307 |
| 4781670 | 109 | 52162 | 507 | 62318 | 485 | 671308 | 68 | 7470240 | 307 |
| 4790910 | 110 | 52164 | 507 | 62321 | 485 | 671310 | 68 | 74702D | 307 |
| 4791210 | 35 | 52170 | 507 | 62322 | 485 | 671312 | 68 | 7470310 | 307 |
| 4791210 | 110 | 52172 | 507 | 62323 | 485 | 671314 | 68 | 7470340 | 307 |
| 4791610 | 35 | 52174 | 507 | 62325 | 485 | 6714CC | 93 | 74703D | 307 |
| 4791610 | 110 | 5220 | 92 | 62326 | 485 | 6714HC | 93 | 75013 | 404 |
| 47933 | 155 | 5223 | 92 | 62327 | 485 | 6714N | 93 | 75015 | 404 |
| 47934 | 155 | 5228 | 92 | 62328 | 485 | 6716CC | 93 | 7512-06 | 515 |
| 47935 | 155 | 52291 | 260 | 6412120 | 103 | 6716HC | 93 | 77519 | 45 |
| 47938 | 155 | 52640 | 237 | 6412230 | 103 | 6716N | 93 | 77520 | 45 |
| 47943 | 155 | 52641 | 237 | 6412335 | 103 | 68296 | 146 | 77521 | 45 |
| 4806-01 | 514 | 52642 | 237 | 6412420 | 103 | 68297 | 146 | 77522 | 45 |
| 4806-06 | 514 | 52643 | 237 | 6412445 | 103 | 68351 | 146 | 77523 | 45 |
| 48070 | 496 | 5283520 | 105 | 6412520 | 103 | 68352 | 146 | 77760 | 45 |
| 4808820 | 112 | 5283620 | 105 | 6412655 | 103 | 691407 | 69 | 77761 | 45 |
| 4808920 | 112 | 5283720 | 105 | 6412865 | 103 | 691408 | 69 | 78204 | 312 |
| 48144 | 443 | 5283920 | 105 | 64130 | 101 | 691410 | 69 | 78710 | 433 |
| 48148 | 443 | 5284120 | 112 | 64132 | 101 | 691412 | 69 | 78720 | 433 |
| 4830-06 | 514 | 5284220 | 105 | 64134 | 101 | 691414 | 69 | 78725 | 433 |
| 4842-01 | 514 | 5284320 | 105 | 6414015 | | | | | |

Numerical index

Índice numérico
Index numériqué

| REF. | PAG. | REF. | PAG. | REF. | PAG. | REF. | PAG. | REF. | PAG. |
|---------|------|--------------|------|--------------------------|---------|--------------------|---------|-----------|------|
| 8242010 | 410 | 90212 | 200 | CT4-23080003 | 297 | M1-L-T1 | 511 | P100861 | 476 |
| 8242014 | 410 | 90213 | 201 | CT4-230DUAL | 296 | M2V-LL-T1-T1 | 511 | P100862 | 476 |
| 8242310 | 410 | 90222 | 200 | CT4H-230950 | 296 | M3V-LLL-T1-T1-T1 | 511 | P100871 | 476 |
| 8242314 | 410 | 90223 | 201 | CTC-3X2V | 515 | M4V-4L-T1-T1-T1-T1 | 511 | P100880 | 476 |
| 8242414 | 410 | 90242 | 200 | CTCL-4B | 514 | MBA92821 | 394 | P100881 | 476 |
| 8242514 | 410 | 90243 | 201 | CTFWH-8B | 514 | N-0001B | 198 | P100882 | 476 |
| 8242610 | 410 | 90252 | 200 | CTNO-06 | 515 | N-0002B | 198 | P100890 | 476 |
| 8242614 | 410 | 90262 | 200 | G58807 | 514 | N-0003B | 198 | P100891 | 476 |
| 8242710 | 410 | 90263 | 201 | HPI4-260002 | 288 | N-0006B | 198 | P100892 | 476 |
| 8242714 | 410 | 90282 | 200 | HPI4-260003 | 288 | P1 | 511 | P100900 | 475 |
| 8242810 | 411 | 90302 | 201 | HPI4-260004 | 288 | P100003P | 198 | P100931 | 477 |
| 8242814 | 411 | 90312 | 201 | HPI4-300002 | 288 | P100004P | 198 | P100932 | 477 |
| 8242914 | 411 | 90322 | 201 | HPI4-300003 | 288 | P100005P | 198 | P100940 | 477 |
| 8243014 | 411 | 90342 | 201 | HPI4-300004 | 288 | P100006P | 198 | P100950 | 477 |
| 8243114 | 411 | 90352 | 201 | HPI4-380002 | 288 | P100008P | 198 | P100951 | 477 |
| 8243210 | 411 | 90362 | 201 | HPI4-380003 | 288 | P100511 | 468 | P100955 | 477 |
| 8243214 | 411 | 90382 | 201 | HPI4-380004 | 288 | P100512 | 468 | P100960 | 477 |
| 8243314 | 411 | 90402 | 201 | INC-80 | 511 | P100520 | 468 | P100965 | 477 |
| 86100 | 222 | 90412 | 201 | INC-80 | 513 | P100521 | 468 | P103322 | 59 |
| 86101 | 222 | 90422 | 201 | INC-80S18 | 513 | P100522 | 468 | P104318 | 59 |
| 86103 | 222 | 90442 | 201 | J1-L-T5 | 512 | P100530 | 469 | P104320 | 59 |
| 86104 | 222 | 90452 | 201 | J2H-LL-T5-T5 | 512 | P100531 | 469 | P104324 | 59 |
| 86105 | 222 | 90462 | 201 | J2V-LL-T5-T5 | 512 | P100540 | 469 | P106320 | 59 |
| 86106 | 222 | 90482 | 201 | J3V-LLL-T5-T5-T5 | 512 | P100541 | 469 | P106324 | 59 |
| 86107 | 222 | 90502 | 200 | K1-L | 511 | P100542 | 469 | P109035 | 117 |
| 86108 | 222 | 90512 | 200 | K1LLDS-T1 | 512 | P100543 | 469 | P109040 | 117 |
| 86109 | 222 | 90522 | 200 | K2H-LC-T1-T2 | 511 | P100544 | 469 | P109045 | 117 |
| 86110 | 222 | 90542 | 200 | K2H-LL-T1-T1 | 511 | P100550 | 469 | P109050 | 117 |
| 86111 | 222 | 90552 | 200 | K2H-LP-T1-T4 | 511 | P100551 | 469 | P110000 | 197 |
| 86113 | 222 | 90562 | 200 | K2VLLDS-T1-T2 | 512 | P100552 | 469 | P110004 | 197 |
| 86114 | 222 | 90622 | 201 | K2V-LC-T1-T2 | 511 | P100553 | 469 | P110004A | 33 |
| 86115 | 222 | 90642 | 201 | K2VLLDS-T1-T1 | 512 | P100554 | 469 | P110004EO | 197 |
| 86116 | 222 | 90662 | 201 | K2V-LL-T1-T1 | 511 | P100570 | 469 | P110005 | 197 |
| 86117 | 222 | 90682 | 201 | K2V-LP-T1-T4 | 511 | P100571 | 469 | P1100BF | 205 |
| 86118 | 222 | 90922 | 201 | K3H-LCC-T1-T2-T2 | 511 | P100572 | 469 | P1100C1 | 203 |
| 86119 | 222 | 90942 | 201 | K3H-LCP-T1-T2-T4 | 511 | P100600 | 468 | P1100C1 | 207 |
| 86120 | 222 | 918-13 | 485 | K3H-LCS-T1-T2-T3 | 511 | P100601 | 468 | P1100P1 | 197 |
| 86121 | 222 | 93100 | 201 | K3H-LLL-T1-T1-T1 | 511 | P100740 | 474 | P1100P1 | 203 |
| 86123 | 222 | 93110 | 201 | K3VLLCLDS-T1-T2-T2 | 512 | P100741 | 474 | P1100P1 | 205 |
| 86124 | 222 | 93200 | 201 | K3V-LCC-T1-T2-T2 | 511 | P100742 | 474 | P1100P1 | 207 |
| 86125 | 222 | 93300 | 201 | K3V-LCP-T1-T2-T4 | 511 | P100754 | 474 | P1100P2 | 197 |
| 86126 | 222 | 93400 | 201 | K3V-LCS-T1-T2-T3 | 511 | P100755 | 474 | P1100P2 | 203 |
| 86127 | 222 | 93500 | 201 | K3V-LLL-T1-T1-T1 | 511 | P100760 | 474 | P1100P3 | 197 |
| 86128 | 222 | 93600 | 201 | K4H-LCCC-T1-T2-T2-T2511 | P100761 | 474 | P1100P3 | 203 | |
| 86129 | 222 | 93900 | 201 | K4H-LCCP-T1-T2-T2-T4511 | P100770 | 474 | P1100P4 | 197 | |
| 88184 | 307 | 95160 | 146 | K4H-LCCS-T1-T2-T2-T3 511 | P100780 | 474 | P1100P4 | 203 | |
| 88204 | 307 | 95320 | 146 | K4H-LLCC-T1-T1-T2-T2 511 | P100792 | 475 | P1100P5 | 197 | |
| 90002 | 200 | 95640 | 146 | K4V-LCCC-T1-T2-T2-T2 511 | P100803 | 475 | P1100P5 | 203 | |
| 90012 | 200 | 97004 | 245 | K4V-LCCP-T1-T2-T2-T4 511 | P100804 | 475 | P1100P6 | 208 | |
| 90013 | 201 | 97005 | 245 | K4V-LCCS-T1-T2-T2-T3 511 | P100805 | 475 | P110101 | 154 | |
| 9002 | 92 | 97006 | 245 | K4V-LLCC-T1-T1-T2-T2 511 | P100807 | 473 | P110101 | 194 | |
| 90022 | 200 | 97007 | 245 | K4X-LCCC-T1-T2-T2-T2 511 | P100808 | 473 | P110201 | 194 | |
| 90023 | 201 | 97168 | 249 | K4X-LCCP-T1-T2-T2-T4 511 | P100813 | 475 | P110202 | 196 | |
| 90042 | 200 | 97181 | 247 | K4X-LCCS-T1-T2-T2-T3 511 | P100814 | 475 | P110401 | 194 | |
| 90043 | 201 | 97208 | 249 | K4X-LLCC-T1-T1-T2-T2 511 | P100816 | 473 | P110402 | 196 | |
| 90052 | 200 | 99710 | 237 | LD2-2 | 513 | P100817 | 473 | P110551 | 194 |
| 90053 | 201 | ADC-4 | 261 | LD3-2 | 513 | P100820 | 475 | P110552 | 196 |
| 90062 | 200 | ADP | 261 | LDS-3 | 515 | P100821 | 475 | P110651 | 194 |
| 90063 | 201 | CADJ-1 | 513 | LDS-4CUP | 515 | P100826 | 473 | P110652 | 196 |
| 90082 | 200 | CADJ-2 | 513 | LS03IB-T1 | 512 | P100827 | 473 | P1106BF | 204 |
| 90102 | 200 | CADJ-3 | 511 | LS03IS18B-T1 | 512 | P100836 | 473 | P1106C1 | 202 |
| 90112 | 200 | CADJ-3 | 513 | LS03IVB-T1 | 512 | P100837 | 473 | P1106F1 | 199 |
| 90122 | 200 | CFIFO-4 | 515 | LS03MS18B-T5 | 512 | P100838 | 473 | P1106F3 | 401 |
| 90142 | 200 | CT2-23035002 | 297 | LS03MVS18B-T5 | 512 | P100840 | 476 | P1106F3A | 401 |
| 90162 | 200 | CT2-23035003 | 297 | LS03PB-T1 | 512 | P100841 | 476 | P1106F3G | 401 |
| 90182 | 200 | CT4-23010000 | 297 | LS03PS18B-T1 | 512 | P100851 | 476 | P1106F3N | 401 |
| 90202 | 200 | CT4-23080002 | 297 | LS03PVB-T1 | 512 | P100860 | 476 | P1106F3R | 401 |

Numerical index

Índice numérico
Index numériqué

| REF. | PAG. | REF. | PAG. | REF. | PAG. | REF. | PAG. | REF. | PAG. |
|----------|------|-----------|------|---------|------|---------|------|----------|------|
| P1106P1 | 206 | P118335 | 58 | P121501 | 194 | P1300P1 | 197 | P1400C1 | 203 |
| P111001 | 194 | P118340 | 58 | P121502 | 196 | P1300P1 | 203 | P1400C1 | 207 |
| P111002 | 196 | P118345 | 58 | P1215BF | 204 | P1300P1 | 205 | P1400P1 | 197 |
| P1110BF | 204 | P118350 | 58 | P1215C1 | 202 | P1300P1 | 207 | P1400P1 | 203 |
| P1110C1 | 202 | P118360 | 58 | P1215P1 | 206 | P1300P2 | 197 | P1400P1 | 205 |
| P1110F1 | 199 | P120000 | 197 | P1215P6 | 208 | P1300P2 | 203 | P1400P1 | 207 |
| P1110F2 | 199 | P120004 | 197 | P122001 | 194 | P1300P3 | 197 | P1400P2 | 197 |
| P1110P1 | 206 | P120004A | 33 | P122002 | 196 | P1300P3 | 203 | P1400P2 | 203 |
| P111111 | 195 | P120004EO | 197 | P122040 | 88 | P1300P4 | 197 | P1400P3 | 197 |
| P111501 | 194 | P120005 | 197 | P122050 | 88 | P1300P4 | 203 | P1400P3 | 203 |
| P111502 | 196 | P120018 | 74 | P122060 | 88 | P1300P5 | 197 | P1400P4 | 197 |
| P1115BF | 204 | P120020 | 74 | P1220BF | 204 | P1300P5 | 203 | P1400P4 | 203 |
| P1115C1 | 202 | P120022 | 74 | P1220C1 | 202 | P1300P6 | 208 | P1400P5 | 197 |
| P1115F1 | 199 | P120024 | 74 | P1220P1 | 206 | P130201 | 194 | P1400P5 | 203 |
| P1115F2 | 199 | P120026 | 74 | P122222 | 195 | P130202 | 196 | P140201 | 195 |
| P1115P1 | 206 | P120028 | 74 | P123040 | 91 | P130401 | 194 | P140651 | 195 |
| P1115P6 | 208 | P120032 | 74 | P123060 | 91 | P130402 | 196 | P1406BF | 204 |
| P112001 | 194 | P120036 | 74 | P123140 | 91 | P130651 | 194 | P1406C1 | 202 |
| P112002 | 196 | P120040 | 74 | P123160 | 91 | P130652 | 196 | P1406P1 | 207 |
| P1120BF | 204 | P1200BF | 205 | P123260 | 91 | P1306BF | 204 | P141001 | 195 |
| P1120C1 | 202 | P1200C1 | 203 | P124024 | 75 | P1306C1 | 202 | P141014 | 60 |
| P1120P1 | 206 | P1200C1 | 207 | P124028 | 75 | P1306P1 | 207 | P141014 | 459 |
| P112324 | 59 | P1200P1 | 197 | P124032 | 75 | P131001 | 194 | P141016 | 60 |
| P112328 | 59 | P1200P1 | 203 | P124036 | 75 | P131002 | 196 | P141016 | 459 |
| P112332 | 59 | P1200P1 | 205 | P124040 | 75 | P131022 | 76 | P141020 | 60 |
| P112335 | 59 | P1200P1 | 207 | P125000 | 195 | P131026 | 76 | P141020 | 459 |
| P112340 | 59 | P1200P2 | 197 | P125038 | 76 | P1310BF | 204 | P141024 | 60 |
| P112345 | 59 | P1200P2 | 203 | P1250BF | 205 | P1310C1 | 202 | P141024B | 399 |
| P112350 | 59 | P1200P3 | 197 | P1250C1 | 203 | P1310P1 | 207 | P141028 | 60 |
| P113035 | 88 | P1200P3 | 203 | P127024 | 75 | P131120 | 400 | P141028B | 399 |
| P113040 | 88 | P1200P4 | 197 | P127028 | 75 | P131165 | 400 | P141032 | 60 |
| P113050 | 88 | P1200P4 | 203 | P127032 | 75 | P131220 | 400 | P141032B | 399 |
| P113060 | 88 | P1200P5 | 197 | P127040 | 75 | P131265 | 400 | P141036 | 60 |
| P113070 | 88 | P1200P6 | 208 | P128018 | 74 | P131501 | 194 | P141040 | 60 |
| P114040 | 88 | P120101 | 154 | P128022 | 74 | P131502 | 196 | P1410BF | 204 |
| P114050 | 88 | P120101 | 194 | P128024 | 74 | P1315BF | 204 | P1410C1 | 202 |
| P114060 | 88 | P120201 | 194 | P128026 | 74 | P1315C1 | 202 | P1410P1 | 207 |
| P114070 | 88 | P120401 | 194 | P128028 | 74 | P1315P1 | 207 | P14126 | 239 |
| P114540 | 88 | P120651 | 194 | P128032 | 74 | P1315P6 | 208 | P14126F1 | 239 |
| P114545 | 88 | P120652 | 196 | P128036 | 74 | P132001 | 194 | P141501 | 195 |
| P115000 | 195 | P1206BF | 204 | P128040 | 74 | P132002 | 196 | P1415BF | 204 |
| P115000 | 254 | P1206C1 | 202 | P128124 | 75 | P132040 | 91 | P1415C1 | 202 |
| P11500BF | 205 | P1206F1 | 199 | P128128 | 75 | P132060 | 91 | P1415P1 | 207 |
| P1150C1 | 203 | P1206F3 | 401 | P128132 | 75 | P1320C1 | 202 | P142000 | 80 |
| P115320 | 58 | P1206F3A | 401 | P128224 | 75 | P1320P1 | 207 | P142001 | 195 |
| P115324 | 58 | P1206F3G | 401 | P128228 | 75 | P132140 | 91 | P142100 | 79 |
| P115340 | 58 | P1206F3N | 401 | P128232 | 75 | P132160 | 91 | P145000 | 195 |
| P116324 | 58 | P1206F3R | 401 | P128324 | 75 | P132260 | 91 | P1450BF | 205 |
| P116328 | 58 | P1206P1 | 206 | P128328 | 75 | P132365 | 89 | P1450C1 | 203 |
| P116332 | 58 | P120820 | 75 | P128332 | 75 | P132560 | 89 | P148020 | 75 |
| P116335 | 58 | P120824 | 75 | P128424 | 75 | P135000 | 195 | P148024 | 75 |
| P116340 | 58 | P120828 | 75 | P128428 | 75 | P13500F | 205 | P148028 | 75</ |

Numerical index

Índice numérico
Index numérique

| REF. | PAG. | REF. | PAG. | REF. | PAG. | REF. | PAG. | REF. | PAG. |
|----------|------|---------|------|----------|------|----------|------|---------|------|
| P15004 | 301 | P160004 | 197 | P19100 | 450 | P203024 | 50 | P214016 | 49 |
| P15005 | 301 | P1600BF | 205 | P191001 | 195 | P204020 | 50 | P214018 | 49 |
| P15006 | 301 | P1600C1 | 203 | P19101 | 450 | P204024 | 50 | P214020 | 49 |
| P15007 | 301 | P1600C1 | 207 | P19103 | 450 | P204028 | 50 | P214022 | 49 |
| P15008 | 301 | P1600P1 | 197 | P19104 | 450 | P204030 | 50 | P214024 | 49 |
| P15010 | 318 | P1600P1 | 203 | P19105 | 450 | P204032 | 50 | P215000 | 195 |
| P150128 | 79 | P1600P1 | 205 | P19106 | 450 | P204035 | 50 | P215000 | 254 |
| P15020 | 313 | P1600P1 | 207 | P19107 | 450 | P204040 | 50 | P216016 | 48 |
| P15027 | 321 | P1600P2 | 197 | P1910BF | 205 | P205020 | 48 | P216018 | 48 |
| P15028 | 321 | P1600P2 | 203 | P1910C1 | 203 | P205024 | 48 | P216020 | 48 |
| P15029 | 315 | P1600P3 | 197 | P1910P1 | 207 | P205028 | 48 | P216024 | 48 |
| P15030 | 315 | P1600P3 | 203 | P19114A | 450 | P205030 | 48 | P216028 | 48 |
| P15033 | 316 | P1600P4 | 197 | P19114N | 450 | P205032 | 48 | P216030 | 48 |
| P15034 | 316 | P1600P4 | 203 | P19114R | 450 | P205035 | 48 | P216032 | 48 |
| P15035 | 294 | P1600P5 | 197 | P19115A | 450 | P205040 | 48 | P216035 | 48 |
| P15038 | 299 | P1600P5 | 203 | P19115N | 450 | P205045 | 48 | P216040 | 48 |
| P15039 | 299 | P1600P6 | 208 | P19115R | 450 | P205050 | 48 | P216045 | 48 |
| P15040 | 300 | P160651 | 195 | P19116 | 450 | P205060 | 48 | P216050 | 48 |
| P15041 | 300 | P1606BF | 205 | P19117 | 450 | P209016 | 49 | P216060 | 48 |
| P15042 | 299 | P1606C1 | 203 | P19118 | 450 | P209018 | 49 | P217016 | 48 |
| P15070 | 295 | P1606P1 | 207 | P19120 | 394 | P209020 | 49 | P217018 | 48 |
| P15071 | 295 | P161001 | 195 | P19126 | 239 | P209020A | 33 | P217020 | 48 |
| P15072 | 290 | P161034 | 60 | P19126F1 | 239 | P209024 | 49 | P217024 | 48 |
| P15073 | 318 | P161038 | 60 | P193918 | 76 | P209024A | 33 | P217028 | 48 |
| P15074 | 318 | P1610BF | 205 | P193920 | 76 | P209028 | 49 | P217030 | 48 |
| P15075 | 294 | P1610C1 | 203 | P193922 | 76 | P209028A | 33 | P217032 | 48 |
| P15077 | 291 | P1610P1 | 207 | P193924 | 76 | P209030 | 49 | P217035 | 48 |
| P15078 | 290 | P161501 | 195 | P193926 | 76 | P209032 | 49 | P217040 | 48 |
| P15079 | 291 | P1615BF | 205 | P193928 | 76 | P209032A | 33 | P217045 | 48 |
| P15081 | 294 | P1615C1 | 203 | P193932 | 76 | P209035 | 49 | P217050 | 48 |
| P15089 | 303 | P1615P1 | 207 | P193936 | 76 | P209040 | 49 | P217060 | 48 |
| P15090 | 303 | P1615P6 | 208 | P195000 | 465 | P209045 | 49 | P218016 | 48 |
| P15091 | 303 | P162001 | 195 | P200012 | 49 | P209050 | 49 | P218018 | 48 |
| P15096 | 318 | P1650BF | 205 | P200014 | 49 | P209060 | 49 | P218020 | 48 |
| P15097 | 318 | P166032 | 81 | P200016 | 49 | P21000 | 451 | P218024 | 48 |
| P151012 | 60 | P169020 | 81 | P200018 | 49 | P21001 | 451 | P218028 | 48 |
| P151012 | 459 | P169024 | 81 | P200020 | 49 | P21003 | 451 | P218030 | 48 |
| P151014 | 60 | P169028 | 81 | P200022 | 49 | P21005 | 451 | P218032 | 48 |
| P151014 | 459 | P169030 | 81 | P200024 | 49 | P21015 | 451 | P218035 | 48 |
| P151016 | 60 | P170020 | 61 | P200028 | 49 | P21016 | 451 | P218040 | 48 |
| P151016 | 459 | P170024 | 61 | P200116 | 49 | P21017 | 451 | P218045 | 48 |
| P151020 | 60 | P170028 | 61 | P200120 | 49 | P21020 | 451 | P218050 | 48 |
| P151020B | 399 | P171024 | 61 | P200320 | 50 | P210201 | 194 | P218060 | 48 |
| P151024 | 60 | P171028 | 61 | P200324 | 50 | P210202 | 196 | P22000 | 367 |
| P151024B | 399 | P173016 | 61 | P20041 | 484 | P21027 | 451 | P22001 | 367 |
| P151028 | 60 | P190000 | 197 | P20042 | 484 | P21028 | 451 | P220018 | 70 |
| P151028B | 399 | P1900BF | 205 | P20050 | 484 | P210401 | 194 | P22002 | 366 |
| P151032 | 60 | P1900C1 | 203 | P20066 | 484 | P210402 | 196 | P220020 | 70 |
| P15105 | 239 | P1900C1 | 207 | P20069 | 484 | P210651 | 194 | P220021 | 366 |
| P15105F1 | 239 | P1900P1 | 197 | P20072 | 419 | P210652 | 196 | P220022 | 70 |
| P151100 | 459 | P1900P1 | 203 | P201016 | 49 | P211001 | 194 | P220023 | 366 |
| P151200 | 459 | P1900P1 | 205 | P201018 | 49 | P211002 | 196 | P220024 | 70 |
| P151300 | 459 | P1900P1 | 207 | P201020 | 49 | P21105 | 239 | P220026 | 70 |
| P151400 | 459 | P1900P2 | 197 | P201024 | 49 | P21105F1 | 239 | P220028 | 70 |
| P152025 | 88 | P1900P2 | 203 | P201028 | 49 | P211501 | 194 | P22003 | 365 |
| P152030 | 88 | P1900P3 | 197 | P201032 | 49 | P211502 | 196 | P220031 | 365 |
| P152035 | 88 | P1900P3 | 203 | P20115 | 239 | P212001 | 194 | P220032 | 70 |
| P152035B | 399 | P1900P4 | 197 | P20115F1 | 239 | P212002 | 196 | P220033 | 365 |
| P152935 | 399 | P1900P4 | 203 | P202016 | 49 | P213018 | 71 | P220036 | 70 |
| P153025 | 79 | P1900P5 | 197 | P202018 | 49 | P213020 | 71 | P22004 | 367 |
| P153034 | 79 | P1900P5 | 203 | P202020 | 49 | P213022 | 71 | P220040 | 70 |
| P153050 | 79 | P19060 | 394 | P202024 | 49 | P213024 | 71 | P22005 | 367 |
| P154020 | 399 | P190651 | 195 | P202028 | 49 | P213026 | 71 | P22006 | 378 |
| P154024 | 399 | P1906BF | 205 | P202032 | 49 | P213028 | 71 | P22007 | 378 |
| P154028 | 399 | P1906C1 | 203 | P203016 | 50 | P213032 | 71 | P22008 | 378 |
| P154032 | 399 | P1906P1 | 207 | P203018 | 50 | P213036 | 71 | P22009 | 375 |
| P160000 | 197 | P19090 | 394 | P203020 | 50 | P213040 | 71 | P22010 | 375 |

Numerical index

Índice numérico
Index numérique

| REF. | PAG. | REF. | PAG. | REF. | PAG. | REF. | PAG. | REF. | PAG. |
|---------|------|----------|------|---------|------|---------|------|---------|------|
| P22011 | 375 | P22117 | 369 | P22250 | 369 | P22362 | 395 | P22420 | 362 |
| P22012 | 367 | P22118 | 369 | P22251 | 369 | P22363 | 340 | P22421 | 362 |
| P22013 | 367 | P22119 | 380 | P22301 | 345 | P22363 | 395 | P22422 | 345 |
| P22014 | 367 | P22120 | 382 | P22302 | 345 | P22364 | 370 | P22423 | 345 |
| P22015 | 367 | P22124 | 373 | P22303 | 345 | P22364 | 395 | P22424 | 342 |
| P22016 | 367 | P22125 | 373 | P223035 | 52 | P22365 | 370 | P22425 | 342 |
| P22019 | 370 | P22126 | 373 | P22304 | 345 | P22365 | 395 | P22426 | 342 |
| P22020 | 370 | P22127 | 342 | P223040 | 52 | P22366 | 340 | P22427 | 342 |
| P22022 | 370 | P22128 | 342 | P22305 | 345 | P22366 | 395 | P22501 | 365 |
| P22023 | 370 | P22129 | 342 | P22306 | 345 | P22367 | 340 | P22502 | 365 |
| P22030 | 383 | P22144 | 373 | P22307 | 345 | P22367 | 395 | P22600 | 371 |
| P22031 | 383 | P22145 | 373 | P22308 | 344 | P22368 | 337 | P22601 | 371 |
| P22033 | 369 | P22150 | 367 | P22309 | 344 | P22369 | 337 | P22602 | 371 |
| P22034 | 369 | P22151 | 367 | P22310 | 348 | P22370 | 337 | P22603 | 371 |
| P22035 | 383 | P22154 | 379 | P22311 | 348 | P22370A | 359 | P22604 | 371 |
| P22036 | 383 | P22156 | 379 | P22312 | 348 | P22370G | 359 | P22610B | 371 |
| P22037 | 364 | P22158 | 379 | P22313 | 348 | P22370N | 359 | P22610N | 371 |
| P22038 | 364 | P22160 | 379 | P22314 | 348 | P22370R | 359 | P22611B | 371 |
| P22039 | 375 | P22161 | 372 | P22315 | 348 | P22371 | 337 | P22611N | 371 |
| P22040 | 378 | P22162 | 372 | P22316 | 348 | P22371A | 359 | P22614B | 371 |
| P22041 | 375 | P22164 | 364 | P22317 | 348 | P22371G | 359 | P22614N | 371 |
| P22042 | 378 | P22165 | 364 | P22318 | 347 | P22371N | 359 | P22620 | 371 |
| P22043 | 375 | P22166 | 364 | P22319 | 347 | P22371R | 359 | P22621 | 371 |
| P22044 | 378 | P22167 | 365 | P22320 | 347 | P22372 | 337 | P22622 | 371 |
| P22045 | 375 | P22168 | 365 | P22321 | 347 | P22373 | 341 | P22640N | 372 |
| P22046 | 378 | P22169 | 363 | P22322 | 343 | P22374 | 341 | P22641N | 372 |
| P22047 | 375 | P22170 | 363 | P22323 | 343 | P22375 | 341 | P22642N | 372 |
| P22048 | 378 | P22171 | 363 | P22324 | 343 | P22376 | 341 | P22650 | 342 |
| P22049 | 375 | P22172 | 363 | P22325 | 343 | P22377 | 334 | P22651 | 342 |
| P22050 | 378 | P22173 | 363 | P22326 | 343 | P22378 | 334 | P22652 | 342 |
| P22051 | 375 | P22174 | 370 | P22327 | 343 | P22379 | 334 | P22660 | 371 |
| P22052 | 378 | P22175 | 370 | P22328 | 343 | P22380 | 334 | P22661 | 371 |
| P22053 | 375 | P22176 | 370 | P22329 | 346 | P22381 | 334 | P22662 | 371 |
| P22054 | 378 | P22177 | 365 | P22330 | 346 | P22382 | 334 | P22663 | 371 |
| P22079 | 378 | P22178 | 369 | P22331 | 346 | P22384 | 334 | P22664 | 371 |
| P22080 | 375 | P22179 | 369 | P22332 | 347 | P22385 | 334 | P22690 | 372 |
| P22081 | 378 | P22180 | 369 | P22333 | 346 | P22386 | 334 | P22691 | 372 |
| P22082 | 375 | P22181 | 369 | P22334 | 346 | P22387 | 334 | P22692 | 372 |
| P220820 | 71 | P22182 | 368 | P22335 | 346 | P22388 | 334 | P22695 | 373 |
| P220824 | 71 | P22183 | 368 | P22336 | 350 | P22389 | 334 | P22696 | 373 |
| P220828 | 71 | P22184 | 368 | P22337 | 350 | P22390 | 334 | P22697 | 373 |
| P22083 | 378 | P22185 | 383 | P22338 | 350 | P22391 | 334 | P22698 | 373 |
| P220832 | 71 | P22200 | 366 | P22339 | 350 | P22393 | 334 | P22700 | 353 |
| P22084 | 375 | P22200A | 366 | P22340 | 350 | P22394 | 334 | P22701 | 353 |
| P22085 | 367 | P22200AM | 366 | P22341 | 350 | P22399 | 339 | P22702 | 353 |
| P22086 | 367 | P22200N | 366 | P22342 | 350 | P22400 | 339 | P22703 | 353 |
| P22087 | 378 | P22200R | 366 | P22343 | 350 | P22401 | 339 | P22704 | 353 |
| P22088 | 380 | P22200V | 366 | P22344 | 349 | P22402 | 339 | P22705 | 353 |
| P22090 | 370 | P22201 | 366 | P22345 | 349 | P224023 | 52 | P22710 | 353 |
| P22094 | 378 | P22202 | 366 | P22346 | 349 | P224026 | 52 | P22711 | 353 |
| P22099 | 367 | P22202A | 366 | P22347 | 349 | P22403 | 339 | P22712 | 353 |
| P22100 | 365 | P22202AM | 366 | P22348 | 349 | P22404 | 338 | P22720 | 356 |
| P22101 | 365 | P22202N | 366 | P22349 | 362 | P22405 | 338 | P22725 | 356 |
| P22102 | 365 | P22202R | 366 | P22350 | 362 | P22406 | 338 | P22726 | 356 |
| P22103 | 364 | P22202V | 366 | P22351 | 362 | P22407 | 338 | P22727 | 356 |
| P22104 | 380 | P22203 | 366 | P22352 | 362 | P22408 | 338 | P22728 | 356 |
| P22105 | 380 | P22203A | 366 | P22353 | 362 | P224 | | | |

Numerical index

Índice numérico
Index numérique

| REF. | PAG. | REF. | PAG. | REF. | PAG. | REF. | PAG. | REF. | PAG. |
|----------|------|---------|------|---------|------|----------|------|---------|------|
| P22755 | 352 | P22885 | 349 | P23500 | 460 | P24705 | 455 | P301165 | 98 |
| P22756 | 352 | P22886 | 349 | P235000 | 195 | P24706 | 455 | P301206 | 98 |
| P22758 | 356 | P22887 | 349 | P23501 | 460 | P24707 | 455 | P301208 | 98 |
| P22759 | 356 | P22888 | 344 | P23502 | 460 | P24708 | 455 | P301210 | 98 |
| P22760 | 352 | P22889 | 344 | P23503 | 460 | P24709 | 455 | P301212 | 98 |
| P22770 | 353 | P22890 | 380 | P23504 | 461 | P24710 | 455 | P301214 | 98 |
| P22772 | 353 | P22891 | 344 | P23505 | 461 | P24711 | 455 | P301216 | 98 |
| P22775 | 351 | P22892 | 344 | P23506 | 461 | P24712 | 455 | P302108 | 99 |
| P22778 | 351 | P22893 | 344 | P23507 | 461 | P24713 | 455 | P302110 | 99 |
| P22779 | 351 | P22894 | 344 | P23508 | 461 | P24714 | 454 | P302112 | 99 |
| P22780 | 355 | P22895 | 345 | P23509 | 461 | P24715 | 454 | P302114 | 99 |
| P22781 | 355 | P22896 | 344 | P23800 | 381 | P24716 | 454 | P302116 | 99 |
| P22782 | 355 | P22897 | 344 | P23800A | 358 | P24717 | 454 | P302118 | 99 |
| P22783 | 355 | P22898 | 344 | P23800G | 358 | P24718 | 454 | P302120 | 99 |
| P22784 | 355 | P22899 | 344 | P23800N | 358 | P24719 | 454 | P302210 | 99 |
| P22800 | 354 | P22901 | 360 | P23800R | 358 | P248028 | 52 | P302212 | 99 |
| P22801 | 354 | P22902 | 360 | P23810 | 381 | P248032 | 52 | P302214 | 99 |
| P22802 | 354 | P22911 | 360 | P23824 | 381 | P248035 | 52 | P302216 | 99 |
| P22803 | 354 | P22912 | 360 | P23825 | 381 | P248040 | 52 | P303016 | 116 |
| P22815 | 354 | P22920 | 382 | P23829 | 381 | P248045 | 52 | P303018 | 116 |
| P22816 | 354 | P22930 | 382 | P23835 | 381 | P26000 | 149 | P303020 | 116 |
| P22817 | 354 | P22940 | 360 | P23836 | 381 | P26001 | 149 | P303022 | 116 |
| P22823 | 354 | P22950 | 360 | P23840 | 381 | P26100 | 498 | P303024 | 116 |
| P22824 | 354 | P22960 | 360 | P23841 | 381 | P28202 | 467 | P303026 | 116 |
| P22825 | 354 | P22971 | 360 | P23842 | 382 | P28252 | 467 | P303200 | 116 |
| P22830 | 357 | P22972 | 360 | P23843 | 382 | P28302 | 467 | P303265 | 98 |
| P22833 | 357 | P22973 | 363 | P23844 | 382 | P28303 | 467 | P306035 | 154 |
| P22834 | 357 | P22974 | 363 | P23845 | 382 | P28403 | 467 | P307020 | 154 |
| P22835 | 357 | P22975 | 363 | P239036 | 77 | P28501 | 467 | P307025 | 154 |
| P22838 | 357 | P22999 | 353 | P239136 | 77 | P28502 | 467 | P307030 | 154 |
| P22839 | 357 | P230000 | 197 | P239236 | 72 | P28503 | 467 | P307035 | 154 |
| P22844 | 357 | P23003 | 505 | P239336 | 72 | P28504 | 467 | P307040 | 154 |
| P22845 | 357 | P23004 | 505 | P239436 | 77 | P28505 | 467 | P307045 | 154 |
| P22850 | 354 | P23008 | 505 | P239536 | 77 | P28506 | 467 | P307050 | 154 |
| P22851 | 354 | P23009 | 505 | P23990 | 351 | P28600 | 466 | P307060 | 154 |
| P22852 | 354 | P230101 | 154 | P23991 | 351 | P28610 | 466 | P307070 | 154 |
| P22860 | 374 | P230101 | 194 | P23992 | 351 | P28620 | 466 | P307125 | 154 |
| P22861 | 374 | P23015 | 505 | P23993 | 351 | P28621 | 466 | P307130 | 154 |
| P22862 | 374 | P230201 | 194 | P240040 | 51 | P29600 | 465 | P307140 | 154 |
| P22863 | 374 | P230202 | 196 | P240050 | 51 | P2960001 | 28 | P307150 | 154 |
| P22864 | 374 | P23030 | 377 | P240401 | 194 | P29610 | 465 | P308030 | 117 |
| P22865 | 374 | P23031 | 377 | P240651 | 194 | P29620 | 465 | P308035 | 117 |
| P22866 | 374 | P23032 | 377 | P241001 | 194 | P29630 | 465 | P308040 | 117 |
| P22867 | 374 | P23033 | 377 | P241040 | 51 | P296415 | 464 | P308045 | 117 |
| P22868 | 374 | P23034 | 377 | P241050 | 51 | P296430 | 464 | P308050 | 117 |
| P22869 | 374 | P23036 | 377 | P241501 | 194 | P2965001 | 465 | P309040 | 88 |
| P22870 | 374 | P23037 | 377 | P242024 | 51 | P296515 | 464 | P309050 | 88 |
| P22871 | 374 | P23038 | 377 | P242028 | 51 | P296530 | 464 | P309060 | 88 |
| P22872 | 374 | P23039 | 377 | P242032 | 51 | P296615 | 464 | P310000 | 493 |
| P22873 | 374 | P23040 | 377 | P242035 | 51 | P296630 | 464 | P311002 | 492 |
| P22874 | 374 | P230401 | 194 | P243024 | 51 | P296715 | 464 | P311004 | 493 |
| P22875 | 374 | P230402 | 196 | P243028 | 51 | P296730 | 464 | P311006 | 492 |
| P22876 | 374 | P23042 | 377 | P243032 | 51 | P29680 | 465 | P311020 | 493 |
| P22877 | 374 | P23043 | 377 | P243035 | 51 | P300024 | 117 | P311071 | 492 |
| P22878 | 374 | P23044 | 377 | P244024 | 52 | P300030 | 117 | P312000 | 493 |
| P22879 | 374 | P23045 | 377 | P244028 | 52 | P300325 | 117 | P313025 | 118 |
| P22880 | 374 | P23046 | 377 | P244032 | 52 | P300335 | 117 | P313030 | 118 |
| P22881 | 374 | P230651 | 194 | P244035 | 52 | P300340 | 117 | P313126 | 118 |
| P22882 | 374 | P230652 | 196 | P24407 | 456 | P30084 | 239 | P313132 | 118 |
| P22883 | 374 | P231001 | 194 | P24409 | 456 | P30084F1 | 239 | P314110 | 99 |
| P22884 | 349 | P231002 | 196 | P24410 | 456 | P301108 | 98 | P314112 | 99 |
| P22884A | 358 | P231501 | 194 | P24411 | 456 | P301109 | 98 | P314210 | 99 |
| P22884B | 358 | P231502 | 196 | P24412 | 457 | P301110 | 98 | P314212 | 99 |
| P22884G | 358 | P232001 | 194 | P24413 | 457 | P301112 | 98 | P314300 | 99 |
| P22884N | 358 | P232002 | 196 | P24414 | 457 | P301114 | 98 | P315010 | 99 |
| P22884NE | 358 | P234020 | 50 | P24415 | 457 | P301116 | 98 | P315012 | 99 |
| P22884R | 358 | P234024 | 50 | P24704 | 455 | P301118 | 98 | P315015 | 99 |

Numerical index

Índice numérico
Index numérique

| REF. | PAG. | REF. | PAG. | REF. | PAG. | REF. | PAG. | REF. | PAG. |
|----------|------|---------|------|---------|------|---------|------|----------|------|
| P315017 | 99 | P325018 | 115 | P350435 | 161 | P373024 | 115 | P41006 | 479 |
| P315020 | 99 | P325020 | 115 | P350440 | 161 | P373028 | 115 | P41007 | 479 |
| P316025 | 156 | P326000 | 492 | P350530 | 161 | P374013 | 115 | P41008 | 462 |
| P316030 | 156 | P327000 | 493 | P350535 | 161 | P374015 | 115 | P41009 | 462 |
| P316035 | 156 | P328020 | 120 | P350630 | 161 | P374018 | 115 | P41010 | 462 |
| P316040 | 156 | P328023 | 120 | P350635 | 161 | P374020 | 115 | P41011 | 462 |
| P316045 | 156 | P328600 | 120 | P350730 | 161 | P374026 | 115 | P41012 | 479 |
| P316050 | 156 | P330035 | 496 | P350735 | 161 | P375010 | 114 | P41013 | 479 |
| P316125 | 156 | P330050 | 496 | P351000 | 448 | P375030 | 115 | P41014 | 479 |
| P316130 | 156 | P330070 | 496 | P352000 | 448 | P375035 | 115 | P41015 | 479 |
| P316135 | 156 | P331039 | 152 | P353000 | 448 | P375061 | 114 | P41016 | 479 |
| P316140 | 156 | P331044 | 152 | P354025 | 156 | P375070 | 114 | P41017 | 479 |
| P316145 | 156 | P331050 | 152 | P354030 | 156 | P375110 | 114 | P41018 | 479 |
| P316150 | 156 | P331056 | 152 | P354035 | 156 | P376037 | 100 | P41019 | 479 |
| P317025 | 438 | P331059 | 152 | P354040 | 156 | P376137 | 100 | P41020 | 479 |
| P317030 | 438 | P331066 | 152 | P354045 | 156 | P377037 | 100 | P44073 | 240 |
| P317035 | 438 | P331070 | 152 | P354050 | 156 | P377137 | 101 | P44073F1 | 240 |
| P317040 | 438 | P332010 | 153 | P355007 | 169 | P379065 | 431 | P454012 | 53 |
| P317045 | 438 | P332095 | 153 | P355008 | 169 | P379500 | 431 | P454014 | 53 |
| P317050 | 438 | P333010 | 479 | P356016 | 155 | P380000 | 113 | P454016 | 53 |
| P317100B | 389 | P333020 | 479 | P356020 | 155 | P381008 | 113 | P454018 | 53 |
| P317100G | 389 | P333035 | 479 | P356024 | 155 | P381010 | 113 | P456016 | 53 |
| P317100S | 389 | P334050 | 124 | P356028 | 155 | P382000 | 113 | P456020 | 53 |
| P317200B | 389 | P334100 | 124 | P356032 | 155 | P383000 | 113 | P456024 | 53 |
| P317200G | 389 | P335002 | 508 | P357000 | 483 | P384000 | 113 | P456028 | 53 |
| P317200S | 389 | P33621 | 445 | P358024 | 108 | P385020 | 112 | P457016 | 53 |
| P317300B | 389 | P33622 | 445 | P358029 | 108 | P385026 | 112 | P457020 | 53 |
| P317300G | 389 | P33623 | 445 | P358040 | 108 | P385030 | 112 | P457024 | 53 |
| P317300S | 389 | P33624 | 445 | P358230 | 447 | P385500 | 114 | P457028 | 53 |
| P317400B | 389 | P33625 | 445 | P358231 | 447 | P386000 | 113 | P458024 | 53 |
| P317400G | 389 | P337030 | 507 | P358232 | 447 | P387065 | 431 | P458028 | 53 |
| P317400S | 389 | P337060 | 507 | P358237 | 447 | P387100 | 432 | P459018 | 72 |
| P317425 | 438 | P337090 | 507 | P358241 | 108 | P387200 | 432 | P459020 | 72 |
| P317430 | 438 | P337150 | 507 | P358242 | 108 | P387500 | 430 | P459024 | 72 |
| P317435 | 438 | P337200 | 507 | P358243 | 108 | P388018 | 497 | P459028 | 72 |
| P317440 | 438 | P33801 | 446 | P358244 | 108 | P389000 | 449 | P459032 | 72 |
| P317445 | 438 | P33802 | 446 | P358245 | 108 | P390000 | 138 | P460018 | 76 |
| P317450 | 438 | P33803 | 446 | P358246 | 108 | P390100 | 138 | P460020 | 76 |
| P317500B | 388 | P33804 | 446 | P358247 | 108 | P391000 | 120 | P460024 | 76 |
| P317500G | 388 | P33805 | 446 | P358301 | 108 | P392065 | 98 | P460026 | 76 |
| P317500S | 388 | P33806 | 446 | P358302 | 108 | P393080 | 156 | P460028 | 76 |
| P318005 | 89 | P33807 | 446 | P358303 | 108 | P393100 | 156 | P460030 | 76 |
| P318040 | 90 | P33808 | 446 | P358304 | 108 | P393125 | 156 | P460032 | 76 |
| P318060 | 90 | P33809 | 446 | P358305 | 108 | P394008 | 100 | P490014A | 55 |
| P318100 | 497 | P340000 | 222 | P358306 | 108 | P394012 | 100 | P490014G | 55 |
| P318211 | 89 | P341000 | 443 | P358307 | 108 | P395038 | 101 | P490014N | 55 |
| P319000 | 497 | P342000 | 443 | P358404 | 108 | P397247 | 101 | P490014R | 55 |
| P319100 | 497 | P343000 | 443 | P358407 | 108 | P397347 | 101 | P490016A | 55 |
| P32083 | 239 | P343400 | 107 | P359000 | 448 | P398024 | 157 | P490016G | 55 |
| P32083F1 | 239 | P343600 | 107 | P361000 | 441 | P398035 | 157 | P490016N | 55 |
| P322101 | 121 | P343700 | 107 | P361100 | 442 | P398042 | 157 | P490016R | 55 |
| P322102 | 121 | P343800 | 107 | P362000 | 441 | P398125 | 157 | P490220A | 71 |
| P322103 | 121 | P344000 | 443 | P362100 | 442 | P398135 | 157 | P490220G | 71 |
| P322104 | 121 | P345000 | 443 | P363000 | 441 | P398140 | 157 | P490220N | 71 |
| P322201 | 121 | P347020 | 116 | P363100 | 442 | P398225 | 157 | | |

Numerical index

Índice numérico
Index numérique

| REF. | PAG. | REF. | PAG. | REF. | PAG. | REF. | PAG. | REF. | PAG. |
|-----------|------|-----------|------|---------|------|----------|------|---------|------|
| P490624A | 55 | P5090E5F1 | 235 | P590008 | 395 | P619002 | 501 | P646310 | 509 |
| P490624G | 55 | P5090F1 | 234 | P590009 | 395 | P620001 | 111 | P646400 | 509 |
| P490624N | 55 | P5091 | 230 | P590010 | 395 | P621000 | 111 | P649050 | 509 |
| P490624R | 55 | P5091F1 | 234 | P590011 | 395 | P623003 | 479 | P649100 | 509 |
| P490628A | 55 | P5160 | 230 | P590012 | 395 | P625000 | 483 | P650000 | 483 |
| P490628G | 55 | P5160E1 | 232 | P590110 | 397 | P630010 | 481 | P685004 | 432 |
| P490628N | 55 | P5160E1F1 | 235 | P590120 | 397 | P630020 | 481 | P688045 | 315 |
| P490628R | 55 | P5160E2 | 232 | P590130 | 397 | P630030 | 481 | P688065 | 291 |
| P490632A | 55 | P5160E2F1 | 235 | P590240 | 397 | P630040 | 481 | P688085 | 294 |
| P490632G | 55 | P5160E3 | 232 | P591001 | 471 | P63052 | 240 | P688087 | 294 |
| P490632N | 55 | P5160E3F1 | 235 | P591002 | 471 | P63052F1 | 240 | P688130 | 314 |
| P490632R | 55 | P5160E4 | 232 | P591003 | 471 | P632001 | 481 | P688133 | 314 |
| P490724A | 55 | P5160E4F1 | 235 | P591004 | 471 | P632002 | 481 | P688134 | 314 |
| P490724G | 55 | P5160E5 | 232 | P591005 | 471 | P632003 | 481 | P688250 | 316 |
| P490724N | 55 | P5160E5F1 | 235 | P591006 | 387 | P632004 | 481 | P688251 | 316 |
| P490724R | 55 | P5160F1 | 234 | P591007 | 387 | P632005 | 481 | P688260 | 316 |
| P490728A | 55 | P5161 | 230 | P595001 | 387 | P632006 | 481 | P688261 | 316 |
| P490728G | 55 | P5161F1 | 234 | P595002 | 387 | P632007 | 481 | P688265 | 315 |
| P490728N | 55 | P5250 | 230 | P595003 | 387 | P632008 | 481 | P688266 | 315 |
| P490728R | 55 | P5250E1 | 232 | P595004 | 387 | P632009 | 481 | P7000 | 268 |
| P490732A | 55 | P5250E1F1 | 235 | P595100 | 391 | P632010 | 481 | P7001 | 268 |
| P490732G | 55 | P5250E2 | 232 | P595110 | 391 | P632011 | 481 | P7002 | 268 |
| P490732N | 55 | P5250E2F1 | 235 | P595111 | 391 | P632012 | 481 | P7003 | 268 |
| P490732R | 55 | P5250E3 | 232 | P595120 | 391 | P632013 | 481 | P7004 | 268 |
| P490928A | 55 | P5250E3F1 | 235 | P595121 | 391 | P632014 | 481 | P7004R | 274 |
| P490928A | 400 | P5250E4 | 232 | P595130 | 391 | P632015 | 481 | P7005 | 268 |
| P490928G | 55 | P5250E4F1 | 235 | P595131 | 391 | P632016 | 481 | P7005R | 274 |
| P490928G | 400 | P5250E5 | 232 | P595200 | 391 | P632017 | 481 | P7006 | 268 |
| P490928N | 55 | P5250E5F1 | 235 | P595300 | 391 | P632018 | 481 | P7006R | 274 |
| P490928N | 400 | P5250F1 | 234 | P596110 | 390 | P632019 | 481 | P7007 | 268 |
| P490928R | 55 | P5251 | 230 | P596111 | 390 | P632020 | 481 | P7008 | 268 |
| P490928R | 400 | P5251F1 | 234 | P596120 | 390 | P632021 | 481 | P7009 | 268 |
| P490932A | 55 | P5360 | 231 | P596121 | 390 | P632022 | 481 | P7010 | 268 |
| P490932A | 400 | P5360E1 | 233 | P596130 | 390 | P632023 | 481 | P7011 | 268 |
| P490932G | 55 | P5360E1F1 | 235 | P596131 | 390 | P632024 | 481 | P7012 | 268 |
| P490932G | 400 | P5360E2 | 233 | P597110 | 392 | P632025 | 481 | P7013 | 268 |
| P490932N | 55 | P5360E2F1 | 235 | P597120 | 392 | P632026 | 481 | P7014 | 268 |
| P490932N | 400 | P5360E3 | 233 | P597130 | 392 | P632027 | 481 | P7015 | 268 |
| P490932R | 55 | P5360E3F1 | 235 | P597140 | 393 | P632028 | 481 | P7016 | 268 |
| P490932R | 400 | P5360E4 | 233 | P597150 | 393 | P632029 | 481 | P7017 | 268 |
| P5000 | 236 | P5360E4F1 | 235 | P597160 | 393 | P632030 | 481 | P7018 | 268 |
| P5001 | 236 | P5360E5 | 233 | P597170 | 392 | P633000 | 481 | P7019 | 268 |
| P5002 | 236 | P5360E5F1 | 235 | P598001 | 386 | P633002 | 481 | P7020 | 268 |
| P5003 | 236 | P5360F1 | 234 | P598002 | 386 | P633003 | 481 | P702026 | 163 |
| P5004 | 237 | P5361 | 231 | P598003 | 386 | P634000 | 481 | P702028 | 163 |
| P5015 | 260 | P5361F1 | 234 | P598700 | 396 | P635000 | 484 | P7021 | 268 |
| P5017 | 260 | P5490 | 231 | P598800 | 396 | P636000 | 484 | P7022 | 268 |
| P5018 | 237 | P5490E1 | 233 | P603012 | 146 | P637000 | 484 | P702230 | 163 |
| P5019 | 237 | P5490E1F1 | 235 | P603015 | 146 | P637100 | 484 | P7023 | 268 |
| P501F1 | 227 | P5490E2 | 233 | P604001 | 146 | P638000 | 483 | P7024 | 268 |
| P501F2 | 227 | P5490E2F1 | 235 | P604002 | 146 | P638003 | 480 | P7025 | 268 |
| P501F3 | 227 | P5490E3 | 233 | P604500 | 145 | P638004 | 480 | P7026 | 268 |
| P501F4 | 227 | P5490E3F1 | 235 | P605000 | 448 | P639000 | 483 | P7027 | 268 |
| P501F5 | 227 | P5490E4 | 233 | P606000 | 448 | P640000 | 244 | P7028 | 268 |
| P501F6 | 227 | P5490E4F1 | 235 | P607000 | 95 | P641100 | 244 | P7029 | 268 |
| P5062 | 236 | P5490E5 | 233 | P607100 | 95 | P642000 | 244 | P7030 | 268 |
| P508015 | 316 | P5490E5F1 | 235 | P609010 | 147 | P643000 | 244 | P703020 | 164 |
| P5090 | 230 | P5490F1 | 234 | P609200 | 147 | P644200 | 509 | P703024 | 164 |
| P5090E1 | 232 | P5491 | 231 | P609705 | 147 | P644240 | 509 | P703028 | 164 |
| P5090E1F1 | 235 | P5491F1 | 234 | P610000 | 138 | P644275 | 509 | P703032 | 164 |
| P5090E2 | 232 | P590001 | 396 | P611000 | 147 | P646000 | 495 | P7031 | 268 |
| P5090E2F1 | 235 | P590002 | 396 | P611001 | 111 | P646100 | 509 | P7032 | 268 |
| P5090E3 | 232 | P590003 | 396 | P615000 | 449 | P646103 | 509 | P7033 | 268 |
| P5090E3F1 | 235 | P590004 | 396 | P616000 | 497 | P646105 | 509 | P7034 | 268 |
| P5090E4 | 232 | P590005 | 396 | P617017 | 448 | P646200 | 509 | P7035 | 268 |
| P5090E4F1 | 235 | P590006 | 396 | P618000 | 449 | P646300 | 509 | P7036 | 268 |
| P5090E5 | 232 | P590007 | 359 | P619000 | 501 | P646301 | 509 | P7037 | 268 |

Numerical index

Índice numérico
Index numérique

| REF. | PAG. | REF. | PAG. | REF. | PAG. | REF. | PAG. | REF. | PAG. |
|---------|------|---------|------|---------|------|---------|------|-------|------|
| P7038 | 268 | P7094 | 272 | P7146R | 274 | P720010 | 165 | P7258 | 272 |
| P7039 | 268 | P7095 | 272 | P7147 | 268 | P720012 | 165 | P7259 | 272 |
| P7040 | 268 | P7096 | 272 | P7147R | 274 | P7201 | 270 | P7260 | 272 |
| P704024 | 163 | P7097 | 272 | P7148 | 268 | P7202 | 270 | P7261 | 272 |
| P704030 | 163 | P7098 | 272 | P7149 | 268 | P7203 | 270 | P7262 | 272 |
| P7041 | 268 | P7099 | 272 | P7150 | 268 | P7204 | 270 | P7263 | 272 |
| P7042 | 268 | P7100 | 272 | P715006 | 165 | P7205 | 270 | P7264 | 272 |
| P7043 | 268 | P710020 | 164 | P7151 | 268 | P7206 | 270 | P7265 | 272 |
| P7044 | 268 | P710024 | 164 | P7152 | 268 | P7207 | 270 | P7266 | 272 |
| P7045 | 268 | P710028 | 164 | P7153 | 268 | P7208 | 270 | P7267 | 272 |
| P7046 | 268 | P7101 | 272 | P7154 | 268 | P7209 | 270 | P7268 | 272 |
| P7047 | 270 | P7102 | 272 | P7155 | 268 | P7210 | 270 | P7269 | 272 |
| P7048 | 270 | P710205 | 316 | P7156 | 268 | P721005 | 165 | P7270 | 272 |
| P7049 | 270 | P710206 | 316 | P7157 | 268 | P721006 | 165 | P7271 | 272 |
| P7050 | 270 | P7103 | 272 | P7158 | 268 | P721007 | 165 | P7272 | 272 |
| P705024 | 94 | P7104 | 272 | P7159 | 268 | P721008 | 165 | P7273 | 272 |
| P705028 | 94 | P7105 | 272 | P7160 | 268 | P721010 | 165 | P7274 | 272 |
| P705032 | 94 | P7106 | 272 | P7161 | 268 | P7211 | 270 | P7275 | 272 |
| P7051 | 270 | P7107 | 272 | P7162 | 268 | P7212 | 270 | P7276 | 272 |
| P7052 | 270 | P7108 | 272 | P7163 | 268 | P7213 | 270 | P7277 | 272 |
| P7053 | 270 | P7109 | 272 | P7164 | 268 | P7214 | 270 | P7278 | 272 |
| P7054 | 270 | P7110 | 272 | P7165 | 268 | P7215 | 270 | P7279 | 272 |
| P7055 | 270 | P711010 | 164 | P7166 | 268 | P7216 | 270 | P7280 | 272 |
| P7056 | 270 | P711012 | 164 | P7167 | 268 | P7217 | 270 | P7281 | 272 |
| P7057 | 270 | P711020 | 164 | P7168 | 268 | P7218 | 270 | P7282 | 269 |
| P7058 | 270 | P711024 | 164 | P7169 | 268 | P7219 | 270 | P7283 | 269 |
| P7059 | 270 | P711028 | 164 | P7170 | 268 | P7220 | 270 | P7284 | 269 |
| P7060 | 270 | P711032 | 164 | P717008 | 165 | P722000 | 165 | P7285 | 269 |
| P706039 | 163 | P7111 | 272 | P717010 | 165 | P7221 | 270 | P7286 | 269 |
| P7061 | 270 | P7112 | 272 | P7171 | 268 | P7222 | 270 | P7287 | 269 |
| P7062 | 270 | P7113 | 272 | P7172 | 268 | P7223 | 270 | P7288 | 269 |
| P7063 | 270 | P7114 | 272 | P7173 | 268 | P7224 | 270 | P7289 | 269 |
| P7064 | 270 | P7115 | 272 | P7174 | 268 | P7225 | 270 | P7290 | 269 |
| P7065 | 270 | P7116 | 272 | P7175 | 268 | P7226 | 270 | P7291 | 269 |
| P7066 | 270 | P7117 | 272 | P7176 | 268 | P7227 | 270 | P7292 | 269 |
| P7067 | 270 | P7118 | 272 | P7177 | 268 | P7228 | 270 | P7293 | 269 |
| P7068 | 270 | P7119 | 272 | P7178 | 268 | P7229 | 270 | P7294 | 269 |
| P7069 | 270 | P7120 | 272 | P7179 | 268 | P7230 | 270 | P7295 | 269 |
| P7070 | 270 | P712022 | 164 | P7180 | 268 | P723024 | 164 | P7296 | 269 |
| P707039 | 163 | P7121 | 272 | P718006 | 165 | P723028 | 164 | P7297 | 269 |
| P7071 | 270 | P7122 | 272 | P718008 | 165 | P7231 | 270 | P7298 | 269 |
| P7072 | 270 | P7123 | 272 | P718010 | 165 | P7232 | 270 | P7299 | 269 |
| P7073 | 270 | P7124 | 272 | P718011 | 165 | P7233 | 270 | P7300 | 269 |
| P7074 | 270 | P7125 | 272 | P7181 | 268 | P7234 | 270 | P7301 | 269 |
| P7075 | 270 | P7126 | 272 | P7182 | 268 | P7235 | 272 | P7302 | 269 |
| P7076 | 270 | P7127 | 272 | P7183 | 268 | P7236 | 272 | P7303 | 269 |
| P7077 | 270 | P7128 | 272 | P7184 | 268 | P7237 | 272 | P7304 | 269 |
| P7078 | 270 | P7129 | 272 | P7185 | 268 | P7238 | 272 | P7305 | 269 |
| P7079 | 270 | P7130 | 272 | P7186 | 268 | P7239 | 272 | P7306 | 269 |
| P7080 | 270 | P713075 | 165 | P7187 | 268 | P7240 | 272 | P7307 | 269 |
| P708008 | 164 | P7131 | 272 | P7188 | 270 | P7241 | 272 | P7308 | 269 |
| P708022 | 164 | P7132 | 272 | P7189 | 270 | P7242 | 272 | P7309 | 269 |
| P708024 | 164 | P7133 | 272 | P7190 | 270 | P7243 | 272 | P7310 | 269 |
| P7081 | 270 | P7134 | 272 | P7191 | 270 | P7244 | 272 | P7311 | 269 |
| P7082 | 270 | P7135 | 272 | P7192 | 270 | P7245 | 272 | P7312 | 269 |
| P7083 | 270 | P7136 | 272 | P7193 | 270 | P7246 | 272 | P7313 | 269 |
| P7084 | 270 | P7137 | 272 | P7194 | 270 | P7247 | 272 | P7314 | 269 |
| P7085 | 270 | | | | | | | | |

Numerical index

Índice numérico
Index numérique

| REF. | PAG. | REF. | PAG. | REF. | PAG. | REF. | PAG. | REF. | PAG. |
|---------|------|-------|------|-------|------|-------|------|---------|------|
| P7324 | 269 | P7388 | 273 | P7455 | 269 | P7522 | 273 | P7590 | 276 |
| P7325 | 269 | P7389 | 273 | P7456 | 269 | P7523 | 273 | P7591 | 276 |
| P7326 | 269 | P7390 | 273 | P7457 | 269 | P7524 | 273 | P7592 | 276 |
| P7327 | 269 | P7391 | 273 | P7458 | 269 | P7525 | 273 | P7593 | 276 |
| P7328 | 269 | P7392 | 273 | P7459 | 269 | P7526 | 273 | P7594 | 276 |
| P7329 | 271 | P7393 | 273 | P7460 | 269 | P7527 | 273 | P7595 | 276 |
| P7330 | 271 | P7394 | 273 | P7461 | 269 | P7528 | 273 | P7596 | 276 |
| P733000 | 166 | P7395 | 273 | P7462 | 269 | P7529 | 273 | P7597 | 276 |
| P7331 | 271 | P7396 | 273 | P7463 | 269 | P7530 | 273 | P7598 | 276 |
| P7332 | 271 | P7397 | 273 | P7464 | 269 | P7531 | 273 | P7599 | 276 |
| P7333 | 271 | P7398 | 273 | P7465 | 269 | P7532 | 273 | P7603 | 274 |
| P7334 | 271 | P7399 | 273 | P7466 | 269 | P7533 | 273 | P7604 | 274 |
| P7335 | 271 | P7400 | 273 | P7467 | 269 | P7534 | 273 | P7605 | 274 |
| P7336 | 271 | P7401 | 273 | P7468 | 269 | P7535 | 273 | P7606 | 274 |
| P7337 | 271 | P7402 | 273 | P7469 | 269 | P7536 | 273 | P7607 | 274 |
| P7338 | 271 | P7403 | 273 | P7470 | 271 | P7537 | 273 | P7608 | 274 |
| P7339 | 271 | P7404 | 273 | P7471 | 271 | P7538 | 273 | P7609 | 274 |
| P7340 | 271 | P7405 | 273 | P7472 | 271 | P7539 | 273 | P7610 | 274 |
| P7341 | 271 | P7406 | 273 | P7473 | 271 | P7540 | 273 | P7611 | 274 |
| P7342 | 271 | P7407 | 273 | P7474 | 271 | P7541 | 273 | P7612 | 274 |
| P7343 | 271 | P7408 | 273 | P7475 | 271 | P7542 | 273 | P7613 | 274 |
| P7344 | 271 | P7409 | 273 | P7476 | 271 | P7543 | 273 | P7614 | 274 |
| P7345 | 271 | P7410 | 273 | P7477 | 271 | P7544 | 273 | P7615 | 274 |
| P7346 | 271 | P7411 | 273 | P7478 | 271 | P7545 | 273 | P7616 | 274 |
| P7347 | 271 | P7412 | 273 | P7479 | 271 | P7546 | 273 | P7617 | 274 |
| P7348 | 271 | P7413 | 273 | P7480 | 271 | P7547 | 273 | P7618 | 274 |
| P7349 | 271 | P7414 | 273 | P7481 | 271 | P7548 | 273 | P7628 | 275 |
| P7350 | 271 | P7415 | 273 | P7482 | 271 | P7549 | 273 | P7629 | 275 |
| P7351 | 271 | P7416 | 273 | P7483 | 271 | P7550 | 273 | P7630 | 275 |
| P7352 | 271 | P7417 | 273 | P7484 | 271 | P7551 | 273 | P7631 | 275 |
| P7353 | 271 | P7418 | 273 | P7485 | 271 | P7552 | 273 | P7632 | 275 |
| P7354 | 271 | P7419 | 273 | P7486 | 271 | P7553 | 273 | P7633 | 275 |
| P7355 | 271 | P7420 | 273 | P7487 | 271 | P7554 | 273 | P7634 | 275 |
| P7356 | 271 | P7421 | 273 | P7488 | 271 | P7555 | 273 | P7635 | 275 |
| P7357 | 271 | P7422 | 273 | P7489 | 271 | P7556 | 273 | P7636 | 275 |
| P7358 | 271 | P7423 | 269 | P7490 | 271 | P7557 | 273 | P7637 | 275 |
| P7359 | 271 | P7424 | 269 | P7491 | 271 | P7558 | 273 | P7638 | 275 |
| P7360 | 271 | P7425 | 269 | P7492 | 271 | P7559 | 273 | P7639 | 275 |
| P736030 | 94 | P7426 | 269 | P7493 | 271 | P7560 | 273 | P7640 | 275 |
| P736034 | 94 | P7427 | 269 | P7494 | 271 | P7561 | 273 | P764008 | 155 |
| P7361 | 271 | P7428 | 269 | P7495 | 271 | P7562 | 273 | P764010 | 155 |
| P7362 | 271 | P7429 | 269 | P7496 | 271 | P7563 | 273 | P764012 | 155 |
| P7363 | 271 | P7430 | 269 | P7497 | 271 | P7564 | 273 | P7641 | 275 |
| P7364 | 271 | P7431 | 269 | P7498 | 271 | P7565 | 273 | P7642 | 275 |
| P7365 | 271 | P7432 | 269 | P7499 | 271 | P7566 | 273 | P7643 | 275 |
| P7366 | 271 | P7433 | 269 | P7500 | 271 | P7567 | 273 | P76430 | 275 |
| P7367 | 271 | P7434 | 269 | P7501 | 271 | P7568 | 273 | P7646 | 276 |
| P7368 | 271 | P7435 | 269 | P7502 | 271 | P7569 | 273 | P7647 | 276 |
| P7369 | 271 | P7436 | 269 | P7503 | 271 | P7570 | 273 | P765020 | 168 |
| P7370 | 271 | P7437 | 269 | P7504 | 271 | P7571 | 273 | P765024 | 168 |
| P7371 | 271 | P7438 | 269 | P7505 | 271 | P7572 | 273 | P768006 | 168 |
| P7372 | 271 | P7439 | 269 | P7506 | 271 | P7573 | 273 | P768008 | 168 |
| P7373 | 271 | P7440 | 269 | P7507 | 271 | P7574 | 273 | P769008 | 168 |
| P7374 | 271 | P7441 | 269 | P7508 | 271 | P7575 | 273 | P769010 | 168 |
| P7375 | 271 | P7442 | 269 | P7509 | 271 | P7576 | 273 | P769018 | 168 |
| P7376 | 273 | P7443 | 269 | P7510 | 271 | P7577 | 273 | P769020 | 168 |
| P7377 | 273 | P7444 | 269 | P7511 | 271 | P7578 | 273 | P769022 | 168 |
| P7378 | 273 | P7445 | 269 | P7512 | 271 | P7579 | 273 | P769025 | 168 |
| P7379 | 273 | P7446 | 269 | P7513 | 271 | P7580 | 273 | P771025 | 168 |
| P7380 | 273 | P7447 | 269 | P7514 | 271 | P7581 | 273 | P777540 | 90 |
| P7381 | 273 | P7448 | 269 | P7515 | 271 | P7582 | 273 | P777548 | 90 |
| P7382 | 273 | P7449 | 269 | P7516 | 271 | P7583 | 273 | P777560 | 90 |
| P7383 | 273 | P7450 | 269 | P7517 | 273 | P7584 | 273 | P778040 | 90 |
| P7384 | 273 | P7451 | 269 | P7518 | 273 | P7585 | 276 | P778048 | 90 |
| P7385 | 273 | P7452 | 269 | P7519 | 273 | P7586 | 276 | P778060 | 90 |
| P7386 | 273 | P7453 | 269 | P7520 | 273 | P7587 | 276 | P779017 | 90 |
| P7387 | 273 | P7454 | 269 | P7521 | 273 | P7588 | 276 | P779021 | 90 |
| | | | | P7521 | 273 | P7589 | 276 | P779026 | 90 |

Numerical index

Índice numérico
Index numérique

| REF. | PAG. | REF. | PAG. | REF. | PAG. | REF. | PAG. | REF. | PAG. |
|---------|------|---------|------|---------|------|-----------|------|---------|------|
| P779060 | 90 | P80260 | 246 | P80970 | 251 | P846025 | 146 | P85200 | 27 |
| P780006 | 167 | P80270 | 246 | P81000 | 320 | P846050 | 146 | P85201 | 28 |
| P780008 | 167 | P80280 | 246 | P810004 | 171 | P846100 | 146 | P85220 | 27 |
| P780010 | 167 | P80282 | 247 | P810006 | 171 | P846200 | 146 | P85222 | 28 |
| P781006 | 167 | P80290 | 246 | P810008 | 171 | P846300 | 146 | P85223 | 28 |
| P781008 | 167 | P80300 | 246 | P810010 | 171 | P848008 | 160 | P85230 | 33 |
| P781010 | 167 | P803000 | 159 | P810012 | 171 | P848014 | 160 | P85231 | 33 |
| P782008 | 167 | P80310 | 246 | P810014 | 171 | P849000 | 170 | P85232 | 33 |
| P782010 | 167 | P80320 | 246 | P81010 | 320 | P850000 | 34 | P853004 | 174 |
| P782012 | 167 | P80330 | 248 | P81020 | 320 | P850001 | 183 | P853006 | 174 |
| P782014 | 167 | P80340 | 248 | P811004 | 171 | P850002 | 183 | P853008 | 174 |
| P782016 | 167 | P80350 | 248 | P811006 | 171 | P850003 | 183 | P853010 | 174 |
| P782018 | 167 | P80360 | 248 | P811008 | 171 | P850004 | 183 | P853012 | 174 |
| P782020 | 167 | P80374 | 246 | P811010 | 171 | P850005 | 183 | P853014 | 174 |
| P782022 | 167 | P80380 | 258 | P811012 | 171 | P850006 | 183 | P854006 | 174 |
| P782024 | 167 | P80390 | 258 | P811014 | 171 | P850007 | 183 | P854008 | 174 |
| P782026 | 167 | P804000 | 159 | P811016 | 171 | P850012 | 183 | P854010 | 174 |
| P782028 | 167 | P80430 | 250 | P812003 | 171 | P850017 | 183 | P854012 | 174 |
| P782075 | 167 | P80440 | 252 | P812005 | 171 | P850018 | 183 | P854014 | 174 |
| P783006 | 167 | P80460 | 253 | P812007 | 171 | P850022 | 183 | P854016 | 174 |
| P783008 | 167 | P80470 | 251 | P812009 | 171 | P850023 | 183 | P855000 | 174 |
| P783010 | 167 | P80480 | 252 | P812011 | 171 | P850024 | 183 | P856000 | 174 |
| P783012 | 167 | P80500 | 253 | P813016 | 171 | P850025 | 183 | P857000 | 174 |
| P783014 | 167 | P805000 | 158 | P813020 | 171 | P850026 | 183 | P859101 | 177 |
| P783016 | 167 | P80510 | 252 | P814000 | 172 | P850027 | 183 | P859102 | 177 |
| P783018 | 167 | P80520 | 251 | P815006 | 172 | P850028 | 183 | P859103 | 177 |
| P783020 | 167 | P80540 | 258 | P815009 | 172 | P850031 | 183 | P859104 | 177 |
| P783022 | 167 | P80550 | 258 | P815012 | 172 | P850033 | 183 | P859105 | 177 |
| P783024 | 167 | P80560 | 258 | P815015 | 172 | P850101 | 34 | P859106 | 179 |
| P783026 | 167 | P80570 | 259 | P816011 | 171 | P850102 | 34 | P859107 | 179 |
| P783028 | 167 | P80580 | 259 | P817005 | 171 | P850104 | 34 | P859109 | 177 |
| P783030 | 167 | P80590 | 259 | P817006 | 171 | P850124 | 182 | P859110 | 177 |
| P784020 | 169 | P80610 | 250 | P817008 | 171 | P850128 | 182 | P859111 | 177 |
| P784025 | 169 | P80620 | 250 | P818000 | 124 | P850222 | 182 | P859113 | 176 |
| P784030 | 169 | P80630 | 250 | P820000 | 172 | P850424 | 182 | P859114 | 178 |
| P784035 | 169 | P80641 | 250 | P821000 | 172 | P850426 | 182 | P859115 | 176 |
| P784040 | 169 | P80670 | 250 | P822000 | 173 | P85050B | 29 | P859116 | 180 |
| P785006 | 167 | P80680 | 246 | P823000 | 173 | P85050CP | 30 | P859117 | 180 |
| P785008 | 167 | P80700 | 223 | P824000 | 173 | P85050R | 29 | P859119 | 181 |
| P785010 | 167 | P807000 | 158 | P830001 | 162 | P85050SS | 29 | P859120 | 181 |
| P788025 | 169 | P80710 | 223 | P830002 | 162 | P850528 | 182 | P859122 | 178 |
| P788050 | 169 | P80720 | 223 | P830003 | 162 | P85090B | 29 | P859123 | 178 |
| P789025 | 169 | P80730 | 223 | P830004 | 162 | P85090CP | 30 | P859124 | 178 |
| P789050 | 169 | P80740 | 258 | P830005 | 162 | P85090MP | 31 | P859125 | 178 |
| P796000 | 166 | P80750 | 259 | P833001 | 95 | P85090MPR | 31 | P859126 | 178 |
| P796100 | 166 | P80760 | 259 | P833002 | 95 | P85090MT | 31 | P859129 | 180 |
| P798040 | 170 | P80770 | 259 | P833003 | 95 | P85090MTR | 31 | P859130 | 178 |
| P798055 | 170 | P80780 | 258 | P834000 | 397 | P85090R | 29 | P859132 | 176 |
| P798056 | 170 | P80790 | 257 | P835000 | 397 | P85090SS | 29 | P859134 | 176 |
| P798065 | 170 | P80810 | 254 | P836110 | 160 | P851001 | 30 | P859135 | 176 |
| P800030 | 170 | P80811 | 254 | P836120 | 160 | P851002 | 30 | P859139 | 176 |
| P800035 | 170 | P80813 | 254 | P836147 | 160 | P851003 | 30 | P859141 | 176 |
| P800040 | 170 | P80814 | 254 | P836200 | 160 | P851004 | 35 | P859142 | 176 |
| P800045 | 170 | P80840 | 253 | P836215 | 160 | P851005 | 35 | P859143 | 176 |
| P800050 | 170 | P80850 | 253 | P837003 | 161 | P851006 | 35 | P859144 | 177 |
| P800055 | 170 | P80870 | 253 | P837005 | 161 | P851007 | 35 | P859150 | 177 |
| P800060 | 170 | P80880 | 253 | P837007 | 161 | P851040 | 170 | P859151 | 177 |
| P800065 | 170 | P80900 | 245 | P839000 | 158 | P851046 | 170 | P859152 | 177 |
| P800070 | 170 | P80910 | 25 | | | | | | |

Numerical index

Índice numérico
Index numérique

| REF. | PAG. | REF. | PAG. | REF. | PAG. | REF. | PAG. | REF. | PAG. |
|---------|------|----------|------|---------|------|---------|------|----------|------|
| P859172 | 178 | P882035 | 505 | P904350 | 418 | P911201 | 141 | P921001 | 221 |
| P859184 | 178 | P882100 | 505 | P904400 | 423 | P911202 | 141 | P922000 | 221 |
| P859185 | 178 | P885025 | 504 | P904500 | 423 | P911301 | 141 | P922100 | 221 |
| P859186 | 179 | P885040 | 504 | P904600 | 420 | P911302 | 141 | P923000 | 221 |
| P859189 | 179 | P885060 | 504 | P904610 | 421 | P911303 | 141 | P923001 | 221 |
| P859190 | 179 | P886035 | 504 | P904612 | 421 | P911304 | 141 | P924001 | 221 |
| P859191 | 179 | P887015 | 504 | P904650 | 421 | P911305 | 141 | P924002 | 221 |
| P859192 | 179 | P887025 | 504 | P904652 | 421 | P911306 | 141 | P924002A | 221 |
| P859195 | 179 | P887060 | 504 | P904660 | 420 | P911401 | 141 | P924002R | 221 |
| P859196 | 179 | P887100 | 504 | P904680 | 421 | P911402 | 141 | P924002V | 221 |
| P859197 | 179 | P890025 | 503 | P904682 | 421 | P911403 | 141 | P925001 | 256 |
| P859198 | 179 | P890035 | 503 | P904711 | 420 | P911404 | 141 | P925002 | 256 |
| P859200 | 180 | P890060 | 503 | P904720 | 419 | P911405 | 141 | P926002 | 478 |
| P859201 | 180 | P891035 | 503 | P904721 | 419 | P911406 | 141 | P926003 | 478 |
| P859202 | 181 | P891060 | 503 | P904725 | 419 | P911407 | 142 | P926004 | 478 |
| P859203 | 181 | P891100 | 503 | P904740 | 420 | P911408 | 141 | P926005 | 478 |
| P859204 | 181 | P892015 | 503 | P904760 | 420 | P911501 | 142 | P926006 | 478 |
| P859205 | 181 | P892015B | 502 | P904780 | 420 | P911502 | 142 | P926007 | 478 |
| P859206 | 180 | P892015N | 502 | P904790 | 417 | P911503 | 142 | P926008 | 478 |
| P859207 | 180 | P892015R | 502 | P904804 | 418 | P911504 | 142 | P926009 | 478 |
| P859210 | 180 | P892025 | 503 | P904809 | 418 | P911505 | 142 | P926010 | 478 |
| P859211 | 180 | P892035 | 503 | P904810 | 418 | P911506 | 142 | P926011 | 478 |
| P859212 | 180 | P892035B | 502 | P904820 | 418 | P911507 | 142 | P926012 | 478 |
| P859219 | 178 | P892035N | 502 | P904850 | 418 | P911508 | 142 | P926051 | 478 |
| P859900 | 184 | P892035R | 502 | P904900 | 425 | P911601 | 142 | P926052 | 478 |
| P859901 | 184 | P892060 | 503 | P90492 | 425 | P911602 | 142 | P926053 | 478 |
| P859902 | 184 | P892060B | 502 | P90493 | 425 | P911603 | 142 | P926300 | 464 |
| P859903 | 184 | P892060N | 502 | P904937 | 421 | P911604 | 142 | P926400 | 464 |
| P859904 | 184 | P892060R | 502 | P904950 | 421 | P911605 | 142 | P926500 | 464 |
| P859905 | 184 | P892100 | 503 | P904975 | 421 | P911606 | 142 | P926600 | 464 |
| P859907 | 185 | P892150 | 503 | P904980 | 421 | P911607 | 142 | P927000 | 439 |
| P859908 | 185 | P892200 | 503 | P904990 | 421 | P911608 | 142 | P928000 | 439 |
| P859909 | 185 | P893025 | 503 | P905015 | 119 | P911701 | 141 | P928001 | 439 |
| P859910 | 185 | P893035 | 503 | P905300 | 416 | P911801 | 141 | P929025 | 94 |
| P859911 | 185 | P894003 | 506 | P905310 | 417 | P911802 | 141 | P929028 | 94 |
| P861045 | 222 | P894004 | 506 | P905320 | 417 | P911803 | 141 | P929030 | 94 |
| P861053 | 222 | P894005 | 506 | P905340 | 417 | P911804 | 141 | P929036 | 94 |
| P862100 | 482 | P895006 | 507 | P905400 | 416 | P911805 | 141 | P929040 | 94 |
| P863000 | 482 | P895010 | 507 | P905410 | 416 | P911806 | 141 | P937000 | 135 |
| P867030 | 380 | P895015 | 507 | P905504 | 415 | P911808 | 141 | P938000 | 138 |
| P867060 | 380 | P895020 | 507 | P905506 | 415 | P911901 | 142 | P940000 | 124 |
| P867090 | 380 | P896001 | 506 | P905508 | 415 | P911902 | 142 | P940090 | 124 |
| P867120 | 380 | P896002 | 506 | P905516 | 415 | P911903 | 142 | P940120 | 124 |
| P868001 | 122 | P896003 | 505 | P905518 | 416 | P911904 | 142 | P941013 | 100 |
| P868002 | 122 | P896008 | 505 | P907024 | 439 | P911905 | 142 | P941015 | 100 |
| P868003 | 122 | P897500 | 430 | P907026 | 439 | P911906 | 142 | P941018 | 100 |
| P868004 | 122 | P898001 | 507 | P908000 | 152 | P911908 | 142 | P941020 | 100 |
| P868005 | 122 | P898002 | 507 | P908001 | 152 | P912001 | 141 | P941022 | 100 |
| P868006 | 122 | P899200 | 435 | P908002 | 152 | P913000 | 142 | P941024 | 100 |
| P868007 | 122 | P899300 | 435 | P908003 | 152 | P913501 | 142 | P941028 | 100 |
| P868008 | 122 | P900000 | 223 | P908004 | 152 | P913601 | 142 | P942000 | 119 |
| P868009 | 122 | P901014 | 142 | P90813 | 427 | P913701 | 142 | P943000 | 119 |
| P870000 | 119 | P901018 | 142 | P908132 | 427 | P913901 | 142 | P944000 | 124 |
| P871000 | 119 | P902000 | 449 | P90814 | 427 | P914080 | 153 | P945037 | 118 |
| P872000 | 114 | P903001 | 433 | P908142 | 427 | P914120 | 153 | P945050 | 118 |
| P872500 | 160 | P903002 | 433 | P90910 | 489 | P914150 | 153 | P945051 | 118 |
| P873045 | 124 | P904113 | 423 | P90911 | 489 | P915080 | 153 | P946001 | 123 |
| P873060 | 124 | P904120 | 423 | P909111 | 92 | P916000 | 153 | P946002 | 123 |
| P873090 | 124 | P904140 | 423 | P909121 | 92 | P916120 | 153 | P946003 | 123 |
| P874000 | 482 | P904142 | 423 | P909211 | 92 | P917080 | 153 | P946004 | 123 |
| P876001 | 470 | P904145 | 423 | P909221 | 92 | P919000 | 220 | P947302 | 149 |
| P876002 | 470 | P904146 | 423 | P90930 | 490 | P919001 | 220 | P947303 | 149 |
| P876003 | 470 | P904155 | 418 | P909340 | 92 | P919002 | 220 | P947400 | 149 |
| P880035 | 505 | P904160 | 423 | P909360 | 92 | P919003 | 220 | P947600 | 149 |
| P880050 | 505 | P904165 | 423 | P909460 | 92 | P920001 | 221 | P947700 | 149 |
| P881100 | 505 | P904200 | 423 | P909559 | 162 | P920002 | 221 | P948066 | 95 |
| P882015 | 505 | P904300 | 397 | P910008 | 314 | P920003 | 221 | P948090 | 95 |

Numerical index

Índice numérico
Index numérique

| REF. | PAG. | REF. | PAG. | REF. | PAG. | REF. | PAG. | REF. | PAG. |
|---------|------|---------|------|----------|------|-------------|------|------------|------|
| P948132 | 95 | P968135 | 35 | P995016 | 84 | PC15PHC | 93 | TRJ | 230 |
| P949025 | 94 | P968135 | 482 | P995016 | 458 | PC15PN | 93 | TRM | 231 |
| P949030 | 94 | P969000 | 482 | P995020 | 84 | PC15SCC | 93 | VCBL100 | 217 |
| P949035 | 94 | P970000 | 116 | P995026 | 84 | PC15SN | 93 | VCBM100 | 217 |
| P949040 | 94 | P972053 | 95 | P995030 | 84 | PC16FPHC | 93 | VDBBM300 | 219 |
| P950000 | 318 | P972060 | 95 | P995034 | 84 | PC16PN | 93 | VDBBM50002 | 219 |
| P950000 | 432 | P972201 | 491 | P995036 | 84 | PC16SHC | 93 | VPB116 | 215 |
| P951010 | 155 | P972202 | 491 | P995038 | 84 | PC18FPHC | 93 | VPB118 | 215 |
| P951015 | 155 | P972203 | 491 | P995040 | 84 | PC18PCC | 93 | VTB300 | 219 |
| P951019 | 155 | P974000 | 493 | P995042 | 84 | PC18PN | 93 | VTB50002 | 219 |
| P951024 | 155 | P975000 | 131 | P995050 | 84 | PC18SCC | 93 | VTBWR-1 | 219 |
| P952001 | 155 | P975501 | 139 | P995060 | 84 | PC18SN | 93 | XMIX0702 | 302 |
| P952002 | 155 | P975600 | 139 | P997014 | 84 | PLC-1 | 513 | XMIX0703 | 302 |
| P952003 | 155 | P975900 | 137 | P997014 | 458 | PLC-2 | 513 | XMIX0704 | 302 |
| P953001 | 155 | P976200 | 492 | P997016 | 84 | PLC-3 | 513 | XMIX0705 | 302 |
| P953002 | 155 | P976210 | 491 | P997016 | 458 | RE8505004 | 30 | | |
| P953003 | 155 | P976300 | 492 | P997028 | 84 | RE8509007 | 30 | | |
| P953004 | 155 | P979000 | 160 | P997032 | 84 | RE851008 | 35 | | |
| P953005 | 155 | P979100 | 160 | P997036 | 84 | RE8514007 | 30 | | |
| P954013 | 118 | P979200 | 160 | P997040 | 84 | RE937001 | 135 | | |
| P954015 | 118 | P980000 | 148 | P998010 | 458 | RE937002 | 135 | | |
| P954020 | 118 | P980050 | 148 | P998012 | 458 | RE937003 | 135 | | |
| P954025 | 118 | P980200 | 147 | P998014 | 458 | RE940001 | 124 | | |
| P955010 | 100 | P980400 | 147 | P998035 | 85 | RE964100 | 138 | | |
| P955012 | 100 | P981500 | 148 | P998050 | 85 | RE964200 | 138 | | |
| P955015 | 100 | P981600 | 148 | P998070 | 85 | RE975001 | 131 | | |
| P955017 | 100 | P981650 | 148 | P999000 | 85 | RE975002 | 131 | | |
| P955020 | 100 | P983000 | 500 | P999012 | 458 | RE975901 | 137 | | |
| P956035 | 501 | P984100 | 500 | P999014 | 458 | RSCL-4 | 513 | | |
| P956040 | 501 | P984500 | 500 | PC07PCC | 93 | S1 | 511 | | |
| P956135 | 501 | P985000 | 500 | PC07PHC | 93 | SAC-SQ5-06 | 261 | | |
| P956140 | 501 | P988100 | 495 | PC07SCC | 93 | SAVC | 261 | | |
| P958010 | 118 | P988200 | 495 | PC07SHC | 93 | SO2-23010.5 | 298 | | |
| P958012 | 118 | P988300 | 495 | PC07SN | 93 | SO2-23014.5 | 298 | | |
| P958014 | 118 | P988400 | 494 | PC08PCC | 93 | T3660 | 435 | | |
| P958016 | 118 | P988500 | 494 | PC08PN | 93 | T7206 | 152 | | |
| P958018 | 118 | P988600 | 494 | PC08SHC | 93 | TR11 | 230 | | |
| P959025 | 156 | P988700 | 494 | PC08SN | 93 | TR11G | 232 | | |
| P959030 | 156 | P988900 | 495 | PC09SCC | 93 | TR11GG | 232 | | |
| P959035 | 156 | P990000 | 495 | PC09SHC | 93 | TR11GGG | 232 | | |
| P959040 | 156 | P99001 | 213 | PC10FPHC | 93 | TR11GGGG | 232 | | |
| P959045 | 156 | P99020 | 214 | PC10PCC | 93 | TR11GGGGG | 232 | | |
| P959050 | 156 | P99021 | 214 | PC10PN | 93 | TR12 | 231 | | |
| P960225 | 157 | P99030 | 216 | PC10SCC | 93 | TR12H | 233 | | |
| P960230 | 157 | P99031 | 216 | PC10SHC | 93 | TR12HH | 233 | | |
| P960235 | 157 | P992040 | 168 | PC10SN | 93 | TR12HHH | 233 | | |
| P962002 | 432 | P992045 | 168 | PC11PCC | 93 | TR12HHHH | 233 | | |
| P962003 | 432 | P992050 | 168 | PC11PHC | 93 | TR12HHHHH | 233 | | |
| P963025 | 94 | P994020 | 84 | PC11PN | 93 | TR13 | 231 | | |
| P963030 | 94 | P994022 | 84 | PC11SHC | 93 | TR13M | 233 | | |
| P963035 | 94 | P994024 | 84 | PC11SN | 93 | TR13MM | 233 | | |
| P963040 | 94 | P994026 | 84 | PC12FPHC | 93 | TR13MMM | 233 | | |
| P964001 | 138 | P994030 | 84 | PC12PCC | 93 | TR13MMMM | 233 | | |
| P967001 | 481 | P994032 | 84 | PC12PHC | 93 | TR18 | 230 | | |
| P967002 | 481 | P994034 | 84 | PC12PN | 93 | TR18J | 232 | | |
| P967003 | 481 | P994036 | 84 | PC12SCC | 93 | TR18JJ | 232 | | |
| P967004 | 481 | P994038 | 84 | PC12SN | 93 | TR18JJJ | 232 | | |
| P967005 | 481 | P994040 | 84 | PC13PCC | 93 | TR18JJJJ | 232 | | |
| P967006 | 481 | P994042 | | | | | | | |

1. GOVERNING PROVISIONS

All sales by PUJADAS – A Vollrath Company (“Seller”) are subject to these terms and conditions, and are expressly conditioned upon assent to these terms and conditions. No additional or different terms or conditions will be binding upon Seller unless specifically agreed to in writing. Seller hereby objects to any such additional or different terms, and notifies buyer that Seller is unwilling to sell on any terms other than these terms and conditions. **Each contract of sale, including these terms and conditions shall constitute the entire agreement between Seller and buyer, and shall be governed by, construed and interpreted according to the laws of Spain, without reference to Principles of Conflicts of Laws. The rights and obligations of the Parties hereunder shall not be governed by the 1980 U.N. Convention on Contracts for the International Sale of Goods; and both parties hereby expressly submit to the jurisdiction of the Courts of Barcelona (Spain), in respect of any proceedings arising out of or in connection with the present General Selling Conditions.** There are no conditions affecting the parties’ agreement which are not expressed in these terms and conditions.

2. TAXES AND OTHER CHARGES

Any manufacturer's tax, occupation tax, use tax, sales tax, excise tax, value added tax, duty, custom, inspection or testing fee, or any other tax, fee, interest or charge of any nature whatsoever imposed by any governmental authority on or measured by the transaction between Seller and buyer shall be paid by buyer in addition to the prices quoted or invoiced. In the event Seller is required to pay any such taxes or other charges, buyer shall reimburse Seller therefore on demand.

3. DELIVERY AND FREIGHT

All items are delivered FCA point of origin (Incoterms 2020). Except as provided below, orders made from the area of the Peninsula and the Balearic Islands with a value over 500 € (1,600 € in Canary Islands) shipping to one location will be shipped PREPAID by Seller. Orders with a value below 500 € will be assessed a 20 € freight charge. (60 € in Canary Islands). For ultimate destinations outside of Spain, all items are FCA Seller's loading dock (as the latter shipping term is defined in Incoterms 2020). Delivery of products to the carrier shall constitute delivery to buyer; and regardless of shipping terms or freight payment, buyer shall bear all risk of loss or damage in transit. Seller reserves the right to make delivery in multiple shipments, unless otherwise expressly stipulated herein; all such shipments to be separately invoiced and paid for when due per invoice, without regard to subsequent deliveries.

Seller reserves ownership rights over all the materials supplied until full payment of the same.

a. Minimum Order Amount and Drop Ship Orders

A 6 € minimum order charge will apply to orders less than One Hundred Euro (100 €) NET. Seller reserves the right to refuse requests to drop ship orders for the same products to one or multiple locations.

b. Quantity

The materials will be supplied in complete packaging containing the quantity indicated in our rates.

c. Custom Smallwares

Custom Smallwares orders are completed with over/under shipments, not to exceed plus or minus 10% of the original order quantity.

4. CLAIMS, DELAYS AND FORCE MAJEURE

Under no circumstances shall claims concerning the condition of the merchandise or regarding shipping mistakes be accepted once 15 workdays have elapsed since the reception thereof.

Claims for shortages or other errors in delivery must be made in writing to Seller within 15 working days after receipt of shipment; and failure to give such notice shall constitute unqualified acceptance and a waiver of all such claims by buyer. **Claims for loss of or damage to goods in transit must be made to the carrier, and not to Seller. OUR RESPONSIBILITY FOR SHIPMENT CEASES WITH ACCEPTANCE BY CARRIERS.**

All delivery dates are approximate. Delay in delivery of any shipment shall not relieve buyer of its obligations to accept remaining shipments. Further, Seller shall not be liable for any losses or damages as a result of any delay or failure to deliver due to any cause beyond Seller's reasonable control, including but not limited to any act of God, act of buyer, arrest or other governmental act, regulation or request, fire, accident, strike, slowdown, war, act of terrorism, riot, delay in transportation, or inability to obtain necessary labor, materials or manufacturing facilities. In the event of any such delay, the date of delivery shall be extended for a period equal to the time lost because of the delay. Buyer's exclusive remedy for other delays and for Seller's inability to deliver for any reason shall be rescission of its agreement to purchase.

5. CHANGES

Seller may at any time make such changes in design and construction of products, components or parts as Seller deems appropriate, without notice to buyer. Seller may furnish suitable substitutes for materials unobtainable because of priorities or regulations established by governmental authority or non-availability of materials from suppliers.

6. WARRANTIES

Seller warrants any smallwares provided hereunder to be free from nonconformity to any attached specifications, and free of defects in materials and workmanship, appearing within 60 days. Seller also warrants any equipment provided hereunder to be free from nonconformity to any attached specifications, and free of defects in materials and workmanship, appearing within 18 months from date of shipment or 12 months from date of purchase by the end user, whichever ends earlier. If within such periods any such applicable goods shall be proved to Seller's satisfaction to be defective, the affected part will be repaired or replaced free of charge, FCA buyer's original destination, or Seller will refund the purchase price of the affected part. Such repair, replacement or refund (whichever Seller determines, in its discretion, to provide) shall be Seller's sole obligation and buyer's exclusive remedy for any deficiency in goods furnished hereunder, and shall be conditioned upon buyer's return of such goods to Seller, .. DDP Seller's loading dock (as the latter shipping term is defined in Incoterms 2020). Any parts repaired or replaced under this warranty are warranted only for the balance of the warranty period on the part that was repaired or replaced. Seller gives no warranty on any goods damaged by accident, carelessness, improper installation, lack of proper setup or supervision (when required) or installed or operated in any manner contrary to the installation and operating instructions. Seller gives no warranty on any repair services performed by unauthorized personnel or unauthorized service agencies.

THE ABOVE WARRANTIES ARE EXCLUSIVE AND IN LIEU OF ALL OTHER REPRESENTATIONS AND WARRANTIES, EXPRESS OR IMPLIED; AND SELLER EXPRESSLY DISCLAIMS AND EXCLUDES ANY IMPLIED WARRANTY OF MERCHANTABILITY OR FITNESS FOR ANY PARTICULAR PURPOSE, AND ANY WARRANTIES ARISING FROM COURSE OF DEALING OR USAGE OF TRADE.

7. CANCELLATIONS AND RETURNS.

No order may be cancelled or altered by buyer except upon terms and conditions acceptable to Seller, as evidenced by Seller's written consent.

Return Authorizations must be requested for all returns. Product returned without prior authorization from Seller's Santa Coloma de Farners office **WILL BE REFUSED.** PUJADAS if free to authorize the return and can decide refuse the return by its free criterion.

a. Requests for returns of merchandise (other than defective merchandise) must be made within **90 DAYS of the PUJADAS INVOICE DATE. PURCHASE ORDER NUMBER or PUJADAS INVOICE NUMBER MUST BE PROVIDED when requesting the authorization. NO RETURN AUTHORIZATION will be issued unless Purchase Order Number or PUJADAS Invoice Number is provided.**

b. **A restocking charge applies as follows:**

1. Merchandise less than 50 € value – 10 € restocking charge.
2. **Merchandise more than 50 € value - 20% restocking charge.**

c. The returns or shipments of materials to the facilities of PUJADAS whether for payment, replacement or repair should always be made **by prepaid freight.**

d. Return Authorization Number must be marked on all returned cartons.

e. **Returns accepted only on current merchandise found in original carton and in new and saleable condition. Merchandise returned that is used, obsolete or shelf-worn will be disposed of and credit WILL NOT be issued.**

1. The return of SHELIVING shall only be performed in complete & original packaging, on pallets if it is more than one packaging and properly protected.

2. The return of TROLLEYS shall be made on pallets and with complete protective packaging.

f. The following items may not be returned: (1) custom smallware, (2) Traex dishwasher racks, (3) personalized items.

Neither shall the return of materials be admitted in which PUJADAS has performed some specific adaptation to comply with the order.

8. PATENTS, TRADEMARKS AND COPYRIGHTS

Seller will, at its own expense, defend any suits that may be instituted by anyone against buyer for alleged infringement of any European Union patent, trademark or copyright relating to goods or services provided by Seller, and pay any final damage award therein, provided buyer shall have made all payments then due hereunder, shall give Seller immediate notice in writing of any such suit, shall transmit to Seller immediately upon receipt all processes and papers served upon buyer, and shall permit Seller, through its counsel, to defend or settle the same either in the name of buyer or in the name of Seller, giving Seller all needed information, assistance and authority to enable Seller to do so. Further, if the result of any such suit is a determination or acknowledgement of infringement, Seller shall, at Seller's option (a) obtain for buyer the right to continue to use the goods or products of the services purchased from Seller, or (b) replace the same with non-infringing goods or services, or (c) modify such goods or services so that they are non-infringing, or (d) remove such goods or products of services and refund to buyer the undepreciated portion of the purchase price, determined on the basis of a five-year useful life.

To the extent that any goods or services that Seller furnishes to buyer are manufactured in accordance with drawings, designs or specifications proposed or furnished by buyer, Seller shall not be liable, and buyer shall indemnify and hold harmless Seller from and against any and all losses, liabilities, damages, claims and expenses (including but not limited to Seller's reasonable attorneys' fees and other costs of defense) incurred by Seller as a result of any claim of patent, trademark, copyright or trade secret infringement, or infringement or any other proprietary rights of third parties.

9. CONSEQUENTIAL DAMAGES AND OTHER LIABILITY; INDEMNITY

Seller's liability with respect to the goods or services sold hereunder shall be limited to the warranty and indemnity provided in sections 7 and 9 of these terms and conditions of sale and, with respect to any other breaches of its contract with buyer, shall be limited to the contract price. **SELLER SHALL NOT BE SUBJECT TO ANY OTHER OBLIGATIONS OR LIABILITIES, WHETHER ARISING OUT OF BREACH OF CONTRACT, WARRANTY, TORT (INCLUDING NEGLIGENCE AND STRICT LIABILITY) OR UNDER OTHER THEORIES OF LAW OR EQUITY, WITH RESPECT TO GOODS OR SERVICES SOLD BY SELLER, OR ANY UNDERTAKINGS, ACTS OR OMISSIONS RELATING THERETO.** Without limiting the generality of the foregoing, Seller specifically disclaims any liability for property damages, penalties, special or punitive damages, damages for lost profits or revenues, down-time, lost good will, cost of capital, cost of substitute goods or services, or for any other types of loss of economic advantage, or for claims of buyer's customers or any third party for any such damages, costs or losses.

SELLER SHALL NOT BE LIABLE FOR AND DISCLAIMS ALL CONSEQUENTIAL, INCIDENTAL, INDIRECT AND CONTINGENT DAMAGES WHATSOEVER.

Buyer shall indemnify and hold harmless Seller from and against any and all losses, liabilities, damages and expenses (including but not limited to attorneys' fees and other costs of defense) that Seller may incur as a result of any claim by buyer or by buyer's customers or by any third party arising out of or in connection with the goods or services sold hereunder, , unless such losses, liabilities, damages or expenses are ultimately determined to be attributable solely to the willful misconduct of Seller.

10. PRICES

The selling prices are those specified in our rates, in reference to the merchandise in our warehouse of Santa Coloma de Farners with non-returnable cardboard packaging.

11. PHOTOS, DATA AND MEASUREMENTS

The photos, **data and measurements in the Seller's catalogue are subject to change,** without prior notice, due to technical or production requirements.

12. PERSONAL DATA PROTECTION

In accordance with the provisions of current legislation on the Protection of Personal Data, VOLLRATH PUJADAS, S.A.U informs the buyer that the personal data collected during the commercial relationship will be processed and incorporated into the seller's files, with the aim of being able to provide the services requested, as well as to keep the buyer informed of new products and services. The data provided will be kept as long as the commercial relationship is maintained and, once it has ended, to meet those requests required under tax legislation. The buyer may, at any time, exercise the rights of access, rectification or erasure, restriction of processing, data portability and opposition by means of a written request to info@pujadas.es, accompanied by a photocopy of your DNI/NIF (National Identity Document/Tax Identification Number). You can also contact the competent Control Authority to submit any complaint that you consider appropriate.

All rights reserved to make changes, without prior notice to articles that appear in this catalogue, particularly in relation to colours and/or prices.

Photographs do not form part of the contract.

1. DISPOSICIONES LEGALES

Todas las ventas realizadas por PUJADAS – Una compañía del grupo Vollrath (en adelante, “el vendedor”) están sujetas a los presentes términos y condiciones, y están expresamente condicionadas por la aceptación de los presentes términos y condiciones. Ningún otro término o condición adicional o diferente será vinculante para el vendedor a menos que se acuerde lo contrario específicamente por escrito. Por el presente el vendedor no acepta otros términos adicionales o diferentes y notifica al comprador que no está dispuesto a vender en virtud de términos diferentes de los presentes términos y condiciones. **Cada contrato de venta, incluyendo los presentes términos y condiciones, constituirá el acuerdo indivisible entre el vendedor y el comprador, y se regirá, interpretará y entenderá según las leyes de España, sin remisión a los Principios sobre Conflictos de Leyes. Los derechos y las obligaciones de las partes en virtud del presente no se regirán por la Convención de las Naciones Unidas sobre los Contratos de Compraventa Internacional de Mercaderías de 1980; y por el presente ambas partes se someten expresamente a la jurisdicción de los tribunales de Barcelona (España), para cualquier proceso judicial que surja de las presentes condiciones generales de venta o relacionado con estas.** No existe ninguna condición que afecte al acuerdo de las partes que no esté expresada en los presentes términos y condiciones.

2. IMPUESTOS Y OTROS CARGOS

Los impuestos del fabricante, impuesto por ocupación, impuesto por el uso, impuesto sobre las ventas, impuesto sobre consumos específicos, impuesto sobre el valor añadido, tasas, tarifas de personalización, inspección o prueba, o cualquier otro impuesto, tasa, interés o cargo de cualquier naturaleza impuesto por una autoridad gubernamental, en virtud de la transacción entre el comprador y el vendedor serán pagados por el comprador, además de los precios cotizados o facturados. Si el vendedor debiera pagar dichos impuestos u otros cargos, el comprador deberá reembolsarlos al vendedor.

3. ENTREGA Y FLETE

Todos los productos se entregarán bajo FCA punto de origen (Incoterms 2020). Con la excepción de lo establecido a continuación, los pedidos realizados desde la zona de la Península Ibérica y las Islas Baleares con un valor superior a 500 € (1.600 € en las Islas Canarias) con envío a un único destino se enviarán PREPAGADOS por el vendedor. Los pedidos con un valor inferior a 500 € (Base Imponible) se grabarán con un cargo por flete de 20 € (60 € en las Islas Canarias). Para destinos finales fuera de España, todos los productos estarán sujetos a FCA muelle de carga del vendedor (según la definición de este último en Incoterms 2020). La entrega de los productos al transportista se considerará entrega al comprador; e independientemente de los términos de envío o el pago del flete, el comprador asumirá todos los riesgos por pérdida o daño durante el transporte. El vendedor se reserva el derecho a hacer la entrega en múltiples envíos, a menos que se estipule lo contrario expresamente en el presente; dichos envíos se facturarán por separado y se pagarán en la fecha que indica cada factura, independientemente de las entregas posteriores. El vendedor se reserva los derechos de propiedad de todos los materiales enviados hasta el pago completo de estos.

a. Gestión por pedido mínimo

Se aplicará un cargo de 6 € por la gestión de pedidos inferiores a 100 € NETOS. El vendedor se reserva el derecho a no aceptar pedidos de envío directo para los mismos productos a uno o múltiples sitios.

b. Cantidad

Los materiales se enviarán con el embalaje completo que contenga la cantidad indicada en nuestras tarifas.

c. Utensilios de cocina a medida

Los pedidos de utensilios de cocina a medida se ejecutan con entregas parciales/sobreenvíos, sin que la diferencia suponga un 10% más o menos de la cantidad original pedida.

d. Para pedidos Urgentes para todo territorio nacional, incluyendo islas Baleares y Canarias, se les aplicará un cargo de 15€ por pedido.

El envío será por “Transporte Ugente” con compromiso de entrega en 24 horas, a excepción de las Islas Canarias y Baleares. En estos casos, el transporte será a cargo del cliente.

4. RECLAMACIONES, RETRASOS Y FUERZA MAYOR

No se aceptarán bajo ninguna circunstancia reclamaciones relativas al estado de la mercancía o a errores de envío tras 15 días laborables desde la recepción de esta.

Las reclamaciones por falta de materiales u otros errores en la entrega deben efectuarse por escrito ante el vendedor en el plazo de 15 días laborables tras la recepción del envío; y el hecho de no notificar dicha reclamación supone la aceptación absoluta y la renuncia a cualquier reclamación por parte del comprador. **Las reclamaciones por pérdidas o daños en los productos durante el transporte deben efectuarse ante el transportista y no ante el vendedor. NUESTRA RESPONSABILIDAD POR EL ENVÍO FINALIZA CON LA ACEPTACIÓN DE ESTE POR PARTE DE LOS TRANSPORTISTAS.**

Todas las fechas de entrega son aproximadas. El retraso en la entrega de cualquier envío no exime al comprador de su obligación de aceptar los envíos restantes. Además, el vendedor no será responsable por las pérdidas o los daños que resulten de los retrasos o de la falta de entrega por cualquier causa fuera del control razonable del vendedor, incluyendo sin limitación fuerza mayor, actos del comprador, embargo u otro acto, norma o petición gubernamental, incendio, accidente, huelga, parones, guerra, acto de terrorismo, disturbios, retraso en el transporte o incapacidad para conseguir la mano de obra, los materiales o las instalaciones de producción necesarios. En caso de algún retraso de este tipo, la fecha de entrega se ampliará durante un plazo igual al tiempo perdido debido al retraso. El único remedio del comprador por otros retrasos y por la incapacidad del vendedor de efectuar la entrega por cualquier motivo será la rescisión de su contrato de compra.

5. MODIFICACIONES

En cualquier momento, el vendedor podrá realizar modificaciones en el diseño y la construcción de los productos, los componentes y las partes como el vendedor lo crea apropiado, sin previo aviso al comprador. El vendedor puede ofrecer sustitutos apropiados del material no disponible debido a las prioridades o normas establecidas por la autoridad gubernamental o la falta de materiales por parte de los proveedores.

6. GARANTÍA

El vendedor garantiza que cualquier utensilio de cocina suministrado en virtud del presente está libre de disconformidad con cualquier especificación adjunta y libre de defectos en los materiales y la calidad, que aparezcan en el plazo de 60 días. El vendedor también garantiza que cualquier equipo suministrado en virtud del presente está libre de disconformidad con cualquier especificación adjunta y libre de defectos en los materiales y la calidad, que aparezcan en el plazo de 18 meses desde la fecha de envío o 12 meses desde la fecha de compra por el usuario final, lo que ocurra antes. Si en dichos plazos cualquier producto pertinente se demuestra a satisfacción del vendedor que es defectuoso, la pieza afectada será reparada o sustituida sin cargo, bajo FCA destino original del comprador, o el vendedor devolverá el precio de compra de la parte afectada. La reparación, la sustitución o la devolución (lo que el vendedor determine, a su discreción) constituirá la única obligación del vendedor y el único remedio del comprador para cualquier deficiencia en los productos suministrados en virtud del presente, y estará condicionada por la devolución de dichos productos al vendedor por parte del comprador, bajo DDP muelle de carga del vendedor (según la definición de este último en Incoterms 2020). Cualquier pieza reparada o sustituida en virtud de esta garantía se garantiza solo durante el período restante de garantía sobre la pieza que ha sido reparada o sustituida. El vendedor no garantiza productos que hayan sido dañados por accidente, imprudencia, instalación indebida, configuración o supervisión (cuando proceda) inadecuadas o que hayan sido instalados o puestos en funcionamiento de cualquier modo que sea contrario a las instrucciones de instalación y funcionamiento. El vendedor no garantiza ningún servicio de reparación efectuado por personal no autorizado o agencias de servicios no autorizadas.

LAS GARANTÍAS ANTERIORES SON EXCLUSIVAS Y SUSTITUYEN TODAS LAS OTRAS ASEVERACIONES Y GARANTÍAS, EXPRESAS O IMPLÍCITAS; Y EL VENDEDOR NO ACEPTA Y EXCLUYE EXPRESAMENTE CUALQUIER GARANTÍA IMPLÍCITA DE COMERCIALIZACIÓN O IDONEIDAD PARA CUALQUIER PROPÓSITO PARTICULAR, Y CUALQUIER GARANTÍA QUE PUEDA SURGIR DE UN ACUERDO O USO COMERCIAL.

7. CANCELACIONES Y DEVOLUCIONES

Ningún pedido podrá ser cancelado ni modificado por el comprador excepto en virtud de los términos y condiciones que pueda aceptar el vendedor, tal como lo indique el consentimiento escrito del vendedor. Se solicitará una autorización de devolución para todas las devoluciones. **SE RECHAZARÁN** las devoluciones de productos que no cuenten con la autorización previa por parte de la oficina del vendedor de Santa Coloma de Farners. PUJADAS tiene libertad para autorizar y devolver y puede decidir rechazar la devolución según su propio criterio.

a. Las solicitudes de devoluciones de mercancía (que no sea mercancía defectuosa) deben efectuarse en el plazo de 90 DÍAS desde la FECHA DE LA FACTURA DE PUJADAS. DEBE INDICARSE EL NÚMERO DE ORDEN DE COMPRA o EL NÚMERO DE FACTURA DE PUJADAS al solicitar la autorización. NO SE EMITIRÁ NINGUNA AUTORIZACIÓN DE DEVOLUCIÓN a menos que se proporcione el número de orden de compra o el número de factura de Pujadas.

b. Se aplicará un cargo por reposición de existencias como se indica a continuación: Para cualquier devolución se cargará un 20% del importe, por demérito y gestión, con un mínimo de 10 €.

c. Las devoluciones o los envíos de materiales a las instalaciones de PUJADAS para su pago, sustitución o reparación deberán efectuarse siempre por flete prepagado.

d. El número de autorización de la devolución deberá marcarse en todos los embalajes de los productos que se devuelvan.

e. Únicamente se aceptarán devoluciones de mercancía actual en su embalaje original, sin usar y en estado vendible. La mercancía devuelta que haya sido usada, esté obsoleta o desgastada se eliminará y NO se emitirá crédito.

1. La devolución de ESTANTERÍAS solo se efectuará si van en su embalaje completo y original, en palés si constan de más de un bulto y correctamente protegidas.

2. La devolución de CARROS se efectuará en palés y con el embalaje protector completo.

f. Los siguientes productos no pueden devolverse: (1) utensilios de cocina a medida, (2) cestas de lavado Traex (3) artículos personalizados.

Tampoco se aceptará la devolución de materiales en los que PUJADAS haya efectuado alguna adaptación concreta para satisfacer el pedido.

8. PATENTES, MARCAS COMERCIALES Y COPYRIGHT

El vendedor, únicamente a su cargo, se defenderá de cualquier demanda realizada por cualquier persona contra el comprador por presunta violación de una patente de la Unión Europea, marca comercial o copyright relacionada con los productos o servicios ofrecidos por el vendedor en virtud del presente, y pagará cualquier indemnización por daños que se otorgue en firme, siempre y cuando el comprador haya realizado todos los pagos en virtud del presente y notifique por escrito al vendedor dicha demanda de inmediato, y transmita de inmediato al vendedor todas las notificaciones procesales y documentos recibidos, y permita al vendedor, a través de su abogado, defenderse de esta o resolverla, ya sea en nombre del comprador o del vendedor, y suministre toda la información, asistencia y autoridad necesarias para permitir al vendedor que así lo haga. Además, si el resultado de cualquier demanda es una resolución o un reconocimiento de infracción, el vendedor deberá, a elección del vendedor: (a) obtener para el comprador el derecho de continuar usando los bienes o productos o los servicios adquiridos del comprador, (b) sustituirlos con productos o servicios que no supongan ninguna infracción, (c), modificar dichos productos o servicios de manera que no supongan ninguna infracción, o (d) eliminar dichos bienes o productos o servicios y reembolsar al comprador la parte no devaluada del precio de compra, considerando una vida útil de cinco años.

En cuanto a los productos o servicios que el vendedor suministra al comprador fabricados partiendo de dibujos, diseños o especificaciones propuestas o suministradas por el comprador, el vendedor no será responsable y el comprador deberá indemnizar y eximir de responsabilidad al vendedor ante cualquier pérdida, responsabilidad, daño, reclamación y gasto (incluyendo sin limitación los honorarios razonables de los abogados del vendedor y otros costes de defensa) incurridos por el vendedor como resultado de una demanda por patente, marca comercial, copyright o violación del secreto comercial, o violación de otro derecho sobre la propiedad de terceros.

9. PERJUICIOS Y OTRA RESPONSABILIDAD; INDEMNIZACIÓN

La responsabilidad del vendedor respecto de los productos o servicios que se vendan en virtud del presente se limitará a la garantía y la indemnización establecidas en las secciones 7 y 9 de los presentes términos y condiciones de venta y, respecto de cualquier otro incumplimiento de su contrato con el comprador, se limitará al precio del contrato. **EL VENDEDOR NO ESTARÁ SUJETO A OTRA OBLIGACIÓN O RESPONSABILIDADES, YA SEA QUE SURJAN DE UN INCUMPLIMIENTO DE CONTRATO, GARANTÍA, ILÍCITO CIVIL (INCLUYENDO NEGLIGENCIA Y RESPONSABILIDAD POR HECHOS AJENOS) U OTRAS DOCTRINAS, RESPECTO DE LOS PRODUCTOS O LOS SERVICIOS OFRECIDOS POR EL VENDEDOR, O CUALQUIER EMPRENDIMIENTO, ACCIÓN U OMISIÓN RELACIONADA CON ESTOS.** Sin limitar el carácter general de lo antedicho, el vendedor específicamente rechaza cualquier responsabilidad por daños a la propiedad, multas, daños cuantificables o punitivos, daños por lucro cesante, inactividad, pérdida de clientela, coste de capital, coste de sustitución de productos o servicios, o cualquier otro tipo de pérdida de ventaja económica, o demandas de los clientes del comprador o de cualquier tercero por dichos daños, costes o pérdidas.

EL VENDEDOR NO SERÁ RESPONSABLE Y NO ACEPTA LA RESPONSABILIDAD POR PERJUICIOS, DAÑOS FORTUITOS, INDIRECTOS Y ACCIDENTALES DE CUALQUIER NATURALEZA.

El comprador eximirá y liberará al vendedor de cualquier pérdida, responsabilidad, daños y gastos (incluyendo sin limitación honorarios razonables de abogados y otros costes de defensa) en que pueda incurrir el vendedor como resultado de cualquier demanda del comprador, de los clientes del comprador o de cualquier tercero derivados de los productos y servicios que se vendan en virtud del presente o relacionados con estos, a menos que se determine en última instancia que dichas pérdidas, responsabilidades, daños o gastos son atribuibles únicamente a la conducta premeditada del vendedor.

10. PRECIOS

Los precios de venta son los que se especifican en nuestras tarifas, en referencia a la mercancía de nuestro almacén de Santa Coloma de Farners con embalaje de cartón no retornable.

11. FOTOGRAFÍAS, INFORMACIÓN Y MEDIDAS

Las fotografías, la información y las medidas indicadas en el catálogo del vendedor pueden sufrir cambios, sin previo aviso, debido a requisitos técnicos o de producción.

12. PROTECCIÓN DE DATOS PERSONALES

De conformidad con lo establecido en la normativa vigente en materia de protección de datos de carácter personal, VOLLRATH PUJADAS, S.A.U informa al comprador que los datos personales recogidos durante la relación comercial serán tratados e incorporados en los ficheros del vendedor, con el objetivo de poder prestar los servicios solicitados, así como también para mantenerlo informado de nuevos productos y servicios. Los datos facilitados se conservarán mientras se mantenga la relación comercial y una vez finalizada se conversarán aquellos que vengan exigidos por la legislación tributaria. En cualquier momento usted podrá ejercer los derechos de acceso, rectificación o supresión, limitación del tratamiento, portabilidad y oposición mediante una petición escrita a info@pujadas.es, acompañada de una fotocopia de su DNI/NIF. También podrá dirigirse a la Autoridad de Control competente para presentar la reclamación que considere oportuna.

Quedan reservados todos los derechos de cambio sin aviso previo, en especial colores o precios para los artículos que aparecen en este catálogo.

Fotografías no contractuales.

Conditions generales de vente

français

1. DISPOSITIONS APPLICABLES.

Toutes les ventes réalisées par PUJADAS – A Vollrath Company (“Le Vendeur”) sont soumises à ces termes et conditions générales, et sont expressément conditionnées à l’acceptation de ces termes et conditions générales. Aucune modalité ou conditions générales différentes ou supplémentaires ne s’imposeront au Vendeur, sauf accord stipulé par écrit. Le vendeur s’oppose à l’ajout de modalités et de conditions différentes et informe l’acheteur que le Vendeur n’est pas disposé à vendre ses produits sous tout autre terme que ces termes et conditions. **Chaque contrat de vente, incluant ces termes et conditions constituera l’accord intégrale entre le Vendeur et l’acheteur, et sera régi par, et interprété conformément aux lois espagnoles, sans égard à aucun principe de conflit de lois. Les droits et obligations des Parties au contrat ne seront pas régis par la Convention 1980 des Nations Unies sur les Contrats de Vente Internationale de marchandise ; et les deux parties au contrat se soumettent expressément à la juridiction des tribunaux de Barcelone (Espagne) pour toute procédure découlant ou en relation avec les présentes conditions générales de vente.** Il n’y a pas de conditions affectant l’accord entre les deux parties au contrat qui ne sont pas exprimés dans ces termes et conditions.

2. TAXES AND AUTRES FRAIS

Toute taxe de fabricant, taxe d’occupation, taxe d’utilisation, taxe de vente, taxe d’accise, taxe sur la valeur ajoutée, droit de douane, taxe d’inspection ou d’examen, ou toute autre taxe, frais, intérêts ou frais de quelque nature que ce soit imposés par une autorité gouvernementale ou mesures pour la transaction entre le Vendeur et l’acheteur doit être payé par l’acheteur en plus du prix estimé ou facturé. Dans l’éventualité où le Vendeur serait tenu de payer de telles taxes ou autres frais, l’Acheteur devra les lui rembourser sur demande.

3. LIVRAISON ET FRET

Tous les articles sont livrés FCA point d’origine (Incoterms 2020). A l’exception des dispositions ci-dessous, les commandes effectuées depuis la péninsule et depuis les Iles Baléares avec une valeur supérieure à 500 € (1,400 € pour les îles Canaries) pour d’expéditions à un unique destin seront expédiées PREPAID (PRÉPAYÉ) par le Vendeur. Les commandes d’une valeur inférieure à 500€ seront évaluées de frais de fret de 20€. (60€ aux Iles Canaries) Pour les commandes dont la destination finale est en dehors d’Espagne, les produits sont livrés FCA dock de chargement du Vendeur (ceci étant défini par les conditions d’expédition des Incoterms 2020). La livraison des produits au transporteur constituera la livraison à l’acheteur ; ce qui signifie qu’indépendamment des conditions d’expédition ou de paiement du fret, l’acheteur doit supporter tous les risques de perte ou de détérioration liés au transport. Le Vendeur se réserve le droit de procéder à la livraison en plusieurs envois, sauf si le contraire est expressément stipulé ci-inclus. Tous les envois multiples devront être facturés et payés séparément au moment de la facturation, sans tenir compte des livraisons ultérieures.

Le Vendeur se réserve le droit de propriété sur tous les produits fournis jusqu’au paiement complet de ces derniers.

a. Montant minimum de la commande et commandes Drop Ship

Des frais minimums de 6 € seront appliqués aux commandes inférieures à 100 € NET.

Le Vendeur se réserve le droit de refuser des demandes de dropshipping pour les mêmes produits à destination d’une ou plusieurs localités.

b. Quantité

Les matériaux seront fournis dans un emballage complet contenant la quantité indiqué dans nos tarifs.

c. Ustensiles personnalisés

Les commandes d’ustensiles personnalisés sont complétées avec des envois inférieurs ou supérieurs, ne dépassant pas plus ou moins 10% de la comande originale.

4. RÉCLAMATIONS, RETARDS ET FORCE MAJEURE

En aucun cas, les réclamations concernant l’état de la marchandise ou des erreurs de livraison ne seront acceptées une fois que 15 jours ouvrables se sont écoulés depuis leur réception.

Les réclamations pour manque de produits ou tout autre erreur de livraison doivent être faites par écrit au Vendeur dans les 15 jours ouvrables suivant la réception de la marchandise. L’omission de donner un tel avis constituerai une acceptation sans réserve et une renonciation à toute réclamation ultérieure de l’acheteur. **Les réclamations pour perte ou détériorations sont à effectuer auprès du transporteur et non de l’acheteur. NOTRE RESPONSABILITÉ QUAND AU TRANSPORT CESSE APRÈS ACCEPTATION DU TRANSPORTEUR.**

Toutes les dates de livraison sont approximatives. Le retard d’une livraison ne libère pas l’acheteur de son obligation d’accepter les envois restants. En outre, Le Vendeur ne serait pas être tenu responsable des pertes ou des dégradations résultant d’un retard ou d’un défaut de livraison en raison de circonstances ou d’évènements indépendants de la volonté du Vendeur, incluant sans s’y limiter tout acte de Dieu, d’actes émanant de l’acheteur, d’actes gouvernementaux, de règlements ou demandes, feu, accident, grève, ralentissement, guerre, acte de terrorisme, émeute, retard dans le transport, incapacité d’un travailleur, défaillance du matériel ou des installations du fabriquant. En cas de retard, la date de livraison est prolongée pour une période égale au temps perdu en raison du retard. Le recours exclusif de l’acheteur pour d’autres retard et pour l’incapacité du Vendeur à livrer la marchandise peut être l’annulation du contrat d’achat.

5. MODIFICATIONS

Le Vendeur peut à tout moment effectuer des changements concernant la conception ou la construction des produits, des composants ou de pièces si le Vendeur les juge appropriés, sans le notifier à l’Acheteur. Le Vendeur peut fournir des substituts appropriés pour les matériaux impossibles de se procurer à cause de priorités ou de règlements imposés par une autorité gouvernementale ou en cas de non disponibilités des matériaux auprès des fournisseurs.

6. GARANTIES

Le vendeur garantit que tous les produits fournis en vertu des présentes CGV sont exempts de non-conformité aux spécifications ci-jointes, et sans défauts de fabrications apparaissant dans les 60 jours. Le vendeur garantit également que tous les équipements fournis en vertu des présentes CGV sont exempts de non-conformité aux spécifications ci-jointes, et sans défauts de fabrications apparaissant dans les 18 mois suivant le date d’envoi ou dans les 12 mois suivant la date d’achat de l’utilisateur final, qui se termine plus tôt. Si au cours de ces périodes il était prouvé au Vendeur que les produits sont défectueux, la part correspondante serait remplacée gratuitement, FCA destination initiale de l’acheteur, ou le Vendeur rembourserait le prix d’achat de la part affectée. Une telle réparation, remplacement ou remboursement (que le Vendeur détermine et accepte à son gré) représente l’unique obligation du Vendeur et le recours exclusif de l’acheteur pour de tels défaut pour des produits fournis dans le cadre de ces conditions générales de vente, et est conditionné au retour des produits par l’acheteur au Vendeur, DDP au dock d’expédition du Vendeur (ceci étant défini par les conditions d’expédition des Incoterms 2020). Toute pièce réparé ou remplacé dans le cadre de cette garantie est garantie seulement sur le solde de la période de garantie de la pièce réparée ou remplacée. Le vendeur ne garantit aucun produit endommagé par accident, négligence, mauvaise installation, manque de maintenance (le cas échéant) ou installation ou utilisation contraires aux instructions d’installation et d’utilisation. Le vendeur n’offre aucune garantie sur les services de réparation effectués par du personnel non autorisé ou des agences non autorisées.

LES GARANTIES CI-DESSUS SONT EXCLUSIVES ET EN LIEU ET PLACE DE TOUTES AUTRES REPRESENTATIONS OU GARANTIES, EXPRESSES OU IMPLICITES, ET LE VENDEUR DECLINE ET EXCLUT TOUTE GARANTIE IMPLICITE DE QUALITE MARCHANDE OU D’ADAPTATION A UN USAGE PARTICULIER, ET TOUTE GARANTIE POUVANT DECOULER DE RAPPORTS D’AFFAIRES OU DE PRATIQUES COMMERCIALES.

français

7. RÉSILIATIONS ET RENVOIS

Ningún pedido podrá ser cancelado ni modificado por el comprador. Aucune commande ne saurait être annulée ou modifiée par l’acheteur excepté dans le cadre des termes et conditions acceptables pour le Vendeur, et avec le consentement écrit de ce dernier.

Des Autorisations de Renvoi doivent être sollicitées pour tout renvoi.

Les produits renvoyer sans autorisation préalable de la part des bureaux du Vendeur à Santa Coloma de Farners **SERONT REFUSÉS.** PUJADAS est libre d’autoriser le renvoi et peut décider de refuser le renvoi sur critères propres.

a. Les demande de renvoi de marchandise (pour un motif autre que produits défectueux) doivent être faites dans les 90 JOURS suivant la DATE DE FACTURATION par PUJADAS. LE NUMÉRO DE COMANDE ou LE NUMÉRO DE LA FACTURE DOIT ÊTRE FOURNI pour une demande d’autorisation. AUCUNE AUTORISATION DE RENVOI ne sera émise si le numéro de commande ou le numéro de facture n’est pas fourni.

b. Des frais de restockage s’appliquent de la façon suivante :

1. Marchandise d’une valeur inférieure à 50€– 10 € de frais de restockage.

2. Marchandise d’une valeur supérieure à 50 € - 20% comme frais de restockage.

c. Les renvois ou les envois de produit à destination des installations de PUJADAS pour des raisons de paiement, de remplacement ou de réparation devraient toujours être effectués en fret payé d’avance.

d. Le Numéro de l’Autorisation de Retour doit être indiqué sur tous les cartons retournés.

e. Les renvois sont acceptés uniquement pour les produits actuels, trouvés dans leurs cartons d’origine, à l’état de neuf et pouvant être revendu. Les produits renvoyer, s’ils sont usés, obsolètes ou présentent des marques de manipulation seront élimés et le crédit NE SERA PAS émis.

1. Le renvoi de RAYONNAGE devra uniquement être effectué dans son emballage complet et original, sur palette s’il s’agit de plus d’un emballage, et parfaitement protégé.

2. Le renvoi de CHARIOTS doit être effectué sur palette et avec l’emballage de protection complet.

f. Les produits suivants ne peuvent pas être renvoyé : (1) Les ustensiles personnalisés, (2) casiers à vaisselle Traex, (3) produits personnalisés.

Le renvoi de produits pour lesquels PUJADAS a dû faire des adaptations pour honorer une demande, ne se pas accepté non plus.

8. BREVETS, MARQUE DÉPOSÉE ET COPYRIGHTS

Le vendeur défendra, à ses frais, tout procès qui pourrait être engagé par un tiers contre l’Acheteur pour la présumée violation d’un brevet, d’une marque déposée ou d’un copyright de l’Union Européenne en relation avec des produits ou des services fournis par le Vendeur, et il paiera toute indemnité finale en cas de dommage et intérêts, à condition que l’Acheteur ait effectué tous les paiement dus, l’acheteur devra immédiatement informer par écrit le Vendeur d’une telle poursuite, il devra de façon immédiate transmettre au Vendeur et dès leur réception les procédures et les documents qui sont notifiés à l’acheteur et devra permettre au Vendeur, via son avocat, de défendre ou régler cette affaire soit au nom de l’acheteur soit au nom du Vendeur, en donnant au Vendeur toutes les informations nécessaires, l’assistance et l’autorité pour lui permettre de le faire. En outre si le résultat d’un tel procès est une condamnation ou la reconnaissance d’une infraction, le Vendeur devra, à l’option du Vendeur (a) obtenir pour l’acheteur le droit de continuer à faire usage des produits ou des services achetés au Vendeur ou (b) remplacer ces derniers par des produits ou des services non litigieux, ou (c) modifier ces produits ou ces services de façon à ce qu’ils ne soient plus litigieux, ou (d) retirer ces produits ou services et rembourser à l’acheteur une valeur inférieure au prix d’achat déterminé en se basant sur une durée de vie utile de 5 ans.

Dans la mesure où tous les produits ou services fournis à l’acheteur par le Vendeur sont fabriqués conformément aux dessins, aux plans ou aux spécificités proposés ou fournis par l’acheteur, le Vendeur ne sera pas responsable, et l’acheteur devra indemniser et décharger le Vendeur pour et contre toute sorte de perte, d’en-cours, de dommages et intérêts, de réclamations et de dépenses (notamment, mais sans s’y limiter les honoraires engagés par le Vendeur pour sa défense et les autres coûts liés à sa défense) engagés par le Vendeur à la suite d’une réclamation pour atteinte au brevet, à la marque déposée, au copyright ou a une atteinte au secret commercial, ou pour tout autre violation du droit de propriété d’un tiers.

Conditions generales de vente

9. DOMMAGES CONSÉCUTIFS ET AUTRES RESPONSABILITÉS ; INDEMNITÉ

La responsabilité du vendeur à l’égard des produits et des services vendus en vertu des conditions présentes est limitée aux garanties et aux indemnités prévues aux articles 7 et 9 des présentes conditions générales de vente et, en ce qui concerne tout autre manquement au contrat qu’il a avec l’acheteur, l’indemnité est limitée au montant du contrat. **LE VENDEUR N’EST SOUMIS A AUCUNE AUTRES OBLIGATIONS OU RESPONSABILITES, DECOULANT D’UNE VIOLATION DU CONTRAT, DE GARANTIES, DE TORTS (INCLUANT LES NEGLIGENCES OU LES RESPONSABILITES STRICTES) OU DANS LE CADRE D’AUTRES THEORIES LEGALES, RELATIVES AUX PRODUITS ET AUX SERVICES VENDUS PAR LE VENDEUR, OU TOUT AUTRE ENGAGEMENT OU OMISSION RELATIF EN CELA.**

Sans limiter la portée de ce qui précède, le vendeur décline expressément toute responsabilité pour les dommages matériels, les pénalités, les dommages spéciaux ou punitifs, les dommages pour la perte de profits ou de revenus, les pertes de temps, la perte de survaleur, le coût du capital, le coût de produits de substitution, ou pour tout autre perte d’un avantage économique ou pour les réclamations des clients de l’acheteur ou tout autre tiers pour de tels dommages, coûts ou pertes.

LE VENDEUR NE SERA PAS RESPONSABLE ET REJETTE TOUS LES DOMMAGES CONSÉCUTIFS, ACCESSOIRES, INDIRECTS ET ÉVENTUELS.

L’acheteur devra indemniser et décharger le Vendeur pour et contre toute sorte de perte, d’en-cours, de dommages et intérêts, et de dépenses (notamment, mais sans s’y limiter les honoraires engagés par le Vendeur pour sa défense et les autres coûts liés à sa défense) que le Vendeur peut encourir à la suite d’une réclamation de l’acheteur ou d’un client de l’acheteur ou d’un tiers découlant ou en relation avec les produits ou les services vendus selon les modalités des présentes, à moins que ces pertes, en-cours, dommages et intérêts ou dépenses ne soient finalement attribué uniquement à la seule faute intentionnelle du Vendeur.

10. PRIX

Les prix de ventes sont ceux détaillés dans nos tarifs, faisant référence à la marchandise de notre entrepôt de Santa Coloma de Farners avec des emballages en carton non consignés.

11. PHOTOS, DONNÉES ET DIMENSIONS

Les photos, **données et dimensions présentes dans le catalogue du Vendeur sont susceptibles d’être modifiées**, sans notification préalable, en raison d’exigences techniques ou de production.

12. PROTECTION DES DONNÉES PERSONNELLES

Conformément à ce qu’établit la réglementation en vigueur en matière de protection de données à caractère personnel, VOLLRATH PUJADAS, S.A.U informe l’acheteur que les données personnelles collectées durant la relation commerciale seront traitées et stockées dans les fichiers du vendeur dans le but de pouvoir offrir les services requis ainsi que pour le tenir informé de nouveaux produits et services. Les données fournies seront conservées tant que durera la relation commerciale et, une fois celle-ci terminée, seules seront conservées celles exigées par la législation fiscale. À tout moment, vous pourrez exercer les droits d’accès, rectification ou suppression, limitation de traitement, portabilité et opposition moyennant demande par écrit adressée à info@pujadas.es, accompagnée d’une photocopie de votre numéro de pièce d’identité/ numéro d’identification fiscale. Vous pourrez aussi vous adresser à l’autorité de contrôle compétente pour présenter la réclamation que vous jugerez pertinente.

Tous les droits de modification sans avis préalable sont réservés, en particulier les couleurs ou les prix des articles figurant dans ce catalogue.

Photographies non contractuelles.

CTPUJADAS2024



8 421661 616515

THE VOLLRATH COMPANY, L.L.C.

1236 North 18th street
Sheboygan, WISCONSIN 53081-3201 USA
Customer Service; 920.459.4851
Fax. 920.459. 6537
Credit: 920.459.5387

VOLLRATH PUJADASSAU

Ctra. de Castanyet, 132
17430 Santa Coloma de Farners
(GIRONA) - SPAIN
Tel. +34 972 84 32 01
info@pujadas.es

VOLLRATH SHANGHAI TRADING LIMITED

Room 906, Building A, Hongwell Plaza, No.1308
Lianhua Road, Minhang District
Shanghai, 201102 CHINA
Tel. 86-21-50589580

VOLLRATH DE MEXICO S. DER.L. DEC.V.

Periférico Sur edificio 2-C
Col. Santa María Tequepexpan
45601 Tlaquepaque, JALISCO MEXICO
Tel. (52) 333.133.6767 or (52) 333.133.6769
Fax. (52) 333.133.6768

VOLLRATH

www.vollrathfoodservice.com

©2023 The Vollrath Company, L.L.C.
An ISO 9001 Certified Company



www.stoeltingfoodservice.com



www.pujadas.es
www.pujadasgrill.com



An ISO 9001 Certified Company

